

International  
Progress Report

**IPR-06-26**

# Äspö Hard Rock Laboratory

## Prototype Repository

Sensors data report  
(Period 010917-060601)  
Report No:15

*Compiled by*

Reza Goudarzi

Lars-Erik Johannesson

Clay Technology AB

July 2006

***Svensk Kärnbränslehantering AB***

Swedish Nuclear Fuel  
and Waste Management Co  
Box 5864  
SE-102 40 Stockholm Sweden  
Tel 08-459 84 00  
+46 8 459 84 00  
Fax 08-661 57 19  
+46 8 661 57 19



**Äspö Hard Rock  
Laboratory**



Report no.	No.
<b>IPR-06-26</b>	<b>F63K</b>
Author	Date
<b>Reza Goudarzi</b>	<b>July 2006</b>
<b>Lars-Erik Johannesson</b>	
Checked by	Date
<b>Lars-Erik Johannesson</b>	<b>2006-11-06</b>
Approved	Date
<b>Anders Sjöland</b>	<b>2006-11-29</b>

# Äspö Hard Rock Laboratory

## Prototype Repository

### Sensors data report (Period 010917-060601) Report No:15

#### *Compiled by*

Reza Goudarzi  
Lars-Erik Johannesson

Clay Technology AB

July 2006

**Keywords:** Fields test, Data, Prototype, Bentonite, Rock, Canister measurements, Water, Pressure, Total pressure, Relative humidity, Temperature, Displacements, Geoelectric

This report concerns a study which was conducted for SKB. The conclusions and viewpoints presented in the report are those of the author(s) and do not necessarily coincide with those of the client.



# Abstract

The Prototype Repository Test consists of two sections. The installation of the first Section of Prototype Repository was made during summer and autumn 2001 and Section 2 was installed in spring and summer 2003.

This report presents data from measurements in the Prototype Repository during the period 010917-060601. The report is organized so that the actual measured results are shown in Appendix 1-10, where Appendix 8 deals with measurements of canister displacements (by AITEMIN), Appendix 9 deals with geo-electric measurements in the backfill (by GRS), Appendix 10 deals with stress and strain measurement in the rock (by BBK) and Appendix 11 deals with measurement of water pressure in the rock (by VBB/VIAK). The main report and Appendix 1-7 deal with the rest of the measurements.

## Section 1

The following measurements are made in the bentonite in each of the two instrumented deposition holes in Section 1 (1 and 3): Temperature is measured in 32 points, total pressure in 27 points, pore water pressure in 14 points and relative humidity in 37 points. Temperature is also measured by all relative humidity gauges. Every measuring point is related to a local coordinate system in the deposition hole.

The following measurements are made in the backfill in Section 1. Temperature is measured in 20 points, total pressure in 18 points, pore water pressure in 23 points and relative humidity in 45 points. Temperature is also measured by all relative humidity gauges. Furthermore, water content is measured by an electric chain in one section. Every measuring point is related to a local coordinate system in the tunnel.

The following measurements are made on the surface of the canisters in Section 1: Temperature is measured every meter along two fiber optic cables. Furthermore, displacements of the canister in hole 3 are measured with 6 gauges.

The following measurements are made in the rock in Section 1: Temperature is measured in 37 points in boreholes in the floor. Water pressure is measured in altogether 64 points in 17 boreholes all around the tunnel.

## Section 2

The following measurements are made in the bentonite in each of the two instrumented deposition holes in Section 2 (5 and 6): Temperature is measured in 29 points, total pressure in 27 points, pore water pressure in 14 points and relative humidity in 47 points deposition hole 5 and in 65 points in deposition hole 6. Temperature is also measured by all relative humidity gauges.

The following measurements are made in the backfill in Section 2. Temperature is measured in 16 points, total pressure in 16 points, pore water pressure in 18 points and relative humidity in 32 points. Temperature is also measured by all relative humidity gauges. Furthermore, water content is measured by an electric chain in one section. Every measuring point is related to a local coordinate system in the tunnel.

The following measurements are made on the surface of the canisters in Section 2: Temperature is measured every meter along two fiber optic cables. Additional to this temperature measurement three conventional thermocouples are placed on each canister. Furthermore, displacements of the canister in hole 6 are measured with 6 gauges.

The following measurements are made in the rock in Section 2: Temperature is measured in 24 points in boreholes close to the deposition holes. Relative humidity is also measured in 6 points in the rock close to deposition hole 6.

### Conclusions

A general conclusion is that the measuring systems and transducers work well, but the number of sensors that has failed is increasing. 212 out of 363 sensors in Section 1 (excluding water pressure sensors in the rock, geo-electric measurements) are out of order, the majority being RH-sensors that fail at water saturation. 86 out of 394 sensors in Section 2 (excluding water pressure sensors in the rock, geo-electric measurements, stress and strain in the rock and displacement of canister) are out of order, some of them due to problems with the data collection system. Furthermore some suction sensors (20) placed in the backfill is not giving reliable values due to high degree of saturation (RH 100%). A new calibration of the fiber optic cables for temperature measurement on the surface of the canisters has been made but it is still preliminary, which means that adjustments of the results may be done afterwards.

The drainages of the inner section together with the drainage of the outer plug were closed at the beginning of November. The pressure (pore pressure and total pressure) both in the backfill and in some parts of the buffer in the six deposition holes increased after this date. At the beginning of December 2004 damages was observed on two of the canisters (canister No 2 and No 6). The power to all of the canisters was then switched off and the drainage of the tunnel was opened. The power of canisters was switched on again on December 15 except for canister No 2 which was out of order. The drainage of the tunnel was kept open. The increase in pore pressure affected the saturation rate of the backfill and the buffer. The failure of canister No 2 and the time when the power was switched off affected also the measurements especially the temperature measurements in the buffer. At the beginning of September 2005 more problems with the power to canister 6 was observed. The power to the canister was switched off for about 2 months. The power to canister 6 was switched on again on November 2 2005. A packer installed in the rock in Section 1 was broken around the 18<sup>th</sup> of April 2006. The broken packer caused an increase in the measured total and pore pressure in the backfill in Section 1.

# Sammanfattning

Prototypförvaret består av två sektioner. Den första sektionen installerades under sommaren och hösten 2001 och Sektion 2 installerades under våren och sommaren 2003.

I denna rapport presenteras data från mätningar i Prototypförvaret för perioden 010917-060601. Rapporten är uppdelad så att själva mätresultaten redovisas i Appendix 1-10, varvid Appendix 8 behandlar mätning av kapselförskjutningar (görs av AITEMIN), Appendix 9 behandlar geoelektriska mätningar i återfyllningen (görs av GRS), Appendix 10 behandlar mätningar av spänning och töjning i berget (handhas av BBK) och Appendix 11 behandlar vattentrycksmätningar i berget (handhas av VBB/VIAK). I själva huvudrapporten och Appendix 1-7 behandlas alla övriga mätningar.

## Sektion 1

Följande mätningar görs i bentoniten i vardera av de två instrumenterade deponeringshålen i Sektion 1 (1 och 3): Temperatur mäts i 32 punkter, totaltryck i 27 punkter, porvattentryck i 14 punkter och relativa fuktigheten i 37 punkter. Temperaturen mäts även med relativa fuktighetsmätare. Varje mätpunkt relateras till ett lokalt koordinatsystem i deponeringshålet.

Följande mätningar görs i återfyllningen i Sektion 1: Temperaturen mäts i 20 punkter, totaltryck i 18 punkter, porvattentryck i 23 punkter och relativa fuktigheten i 45 punkter. Temperaturen mäts även med alla relativa fuktighetsmätare. Varje mätpunkt relateras till ett lokalt koordinatsystem i tunneln. Dessutom mäts vatteninnehållet i en sektion med en geoelektrisk mätkedja.

Följande mätningar görs på ytan i kapselns kopparhölje i samtliga 4 kapslar i Sektion 1: Temperaturen mäts varje meter längs två fiberoptiska kablar från två håll. Dessutom mäts förskjutningar av kapseln i hål 3 med 6 givare.

Följande mätningar görs i berget i Sektion 1: Temperatur mäts i borrhål i 37 punkter i golvet. Vattentryck mäts i sammanlagt 64 punkter i 17 borrhål runt hela tunneln.

## Sektion 2

Följande mätningar görs i bentoniten i vardera av de två instrumenterade deponeringshålen i Sektion 2 (5 och 6): Temperatur mäts i 29 punkter, totaltryck i 27 punkter, porvattentryck i 14 punkter och relativa fuktigheten i 47 punkter i deponeringshål 5 och 65 punkter i deponeringshål 6. Temperaturen mäts även i alla relativa fuktighetsmätare.

Följande mätningar görs i återfyllningen i Sektion 2: Temperaturen mäts i 16 punkter, totaltryck i 16 punkter, porvattentryck i 18 punkter och relativa fuktigheten i 32 punkter. Temperaturen mäts även med alla relativa fuktighetsmätare. Varje mätpunkt relateras till ett lokalt koordinatsystem i tunneln. Dessutom mäts vatteninnehållet i en sektion med en geoelektrisk mätkedja.

Följande mätningar görs på ytan i kapselns kopparhölje i de två kapslarna i Sektion 2: Temperaturen mäts varje meter längs två fiberoptiska kablar från två håll. Vidare mäts temperaturen i tre punkter på varje kapsel med konventionella termoelement. Även förskjutningen av kapseln i deponeringshål 6 mäts med 6 givare.

Temperatur mäts i berget kring varje kapsel i 24 punkter. Vidare mäts RH i berget kring deponeringshål 6 i 6 punkter.

### Slutsatser

En generell slutsats är att mätsystemen och givarna tycks fungera bra. 212 av 363 givare i Sektion 1 (med undantag av vattentrycksmätare i berget) fungerar inte. Många av dessa (64 stycken) är RH-mätare som slutar fungera vid vattenmättnad. 86 av 394 givare i Sektion 2 (med undantag av vattentrycksmätare i berget) fungerar inte, en del av dessa p.g.a. datascan problem. Dessutom har en del psychrometrar (21) placerade i återfyllningen slutat att ge relevanta värden på grund av att fyllningen närmar sig vattenmättnad. Kalibrering av de fiberoptiska kablarna för temperaturmätning på kapselytorna har gjorts men den är fortfarande preliminär varför nya efterjustering av resultaten kan bli aktuell.

Dräneringen av den inre sektionen och den yttre pluggen stängdes i början av november. Portrycket och totaltrycket både i återfyllnaden och i bufferten ökade markant efter stängningen av dränaget. Ökningen av portrycket påverkade också vattenmättnaden i vissa delar av buffert och återfyllnade. Skador observerades på två av kapslarna i början av december 2004, varefter effekten till samtliga kapslar stängdes av samtidigt som dräneringen av tunneln öppnades. Effekten till alla kapslar utom kapsel nr. 2 sattes på igen den 15:e december. Skadorna på kapsel 2 var så omfattande att det inte var möjligt att koppla in någon effekt på denna. Dräneringen av tunneln förblev öppen. I början av september 2005 uppstod nya problem med kapsel Nr 6. Effekten till kapseln stängdes av under ca 2 månader. Från och med den 2:a november 2005 sattes effekten till kapsel Nr 6 på igen. En packer installerad i berget i Sektion 1 gick sönder kring den 18:e april 2006. Den läckande packern medförde att totaltrycken och portrycken i återfyllningen i Sektion ökade markant.



# Contents

<b>1</b>	<b>Introduction</b>	<b>11</b>
<b>2</b>	<b>Geometry and coordinate systems</b>	<b>13</b>
<b>3</b>	<b>Brief description of the instruments</b>	<b>15</b>
	Measurements of temperature	15
	Measurement of total pressure in the buffer and backfill	15
	Measurement of pore water pressure in the buffer and backfill	15
	Measurement of the water saturation process in the buffer and backfill	15
<b>4</b>	<b>Location of instruments in Section 1</b>	<b>17</b>
4.1	Strategy for describing the position of each device in the bentonite and rock in and around the deposition holes	17
4.2	Position of each instrument in the bentonite in hole 1 (DA3587G01)	19
4.3	Position of each instrument in the bentonite in hole 3 (DA3575G01)	23
4.4	Instruments on the canister surface in holes 1-4	27
4.5	Position of temperature sensors in the rock	29
4.6	Strategy for describing the position of each device in the backfill in section 1	31
4.7	Position of each instrument in the backfill	33
<b>5</b>	<b>Results and comments for Section 1</b>	<b>37</b>
5.1	General	37
5.2	Deposition hole 1	38
	5.2.1 Total pressure	38
	Geokon (App. 1\pages 85-87)	38
	Kulite (App. 1\page 88)	38
	5.2.2 Relative humidity	39
	Vaisala (App. 1\pages 89-92)	39
	Rotronic (App. 1\pages 93-97)	39
	5.2.3 Pore water pressure	39
	Geokon (App. 1\page 98)	39
	Kulite (App. 1\page 99)	39
	5.2.4 Temperature in the buffer (App. 1\pages 100-106)	39
	5.2.5 Canister power in dep. hole 1 (App. 1\page 110)	40
	5.2.6 Temperature on the canister surface (App. 1\pages 111-112)	40
5.3	Deposition hole 3	40
	5.3.1 Total pressure	40
	Geokon (App. 2\pages 115-117)	40
	Kulite (App. 2\pages 118-119)	40
	5.3.2 Relative humidity	41
	Vaisala (App. 2\pages 120-123)	41
	Rotronic (App. 2\pages 124-128)	41
	5.3.3 Pore water pressure.	41
	Geokon (App. 2\page 129)	41
	Kulite (App. 2\page 130)	41
	5.3.4 Temperature in the buffer (App. 2\pages 131-137 and 140)	41
	5.3.5 Canister power (App. 2\page 141)	42
	5.3.6 Temperature on the canister surface (App. 2\pages 142-143)	42

5.4	Deposition hole 2	42
5.4.1	Canister power (App. 3\page 148)	42
5.4.2	Temperature on the canister surface (App. 3\pages 149-150)	42
5.5	Deposition hole 4	42
5.5.1	Canister power (App. 3\page 153)	42
5.5.2	Temperature on the canister surface (App. 3\pages 154-155)	43
5.6	Backfill in Section 1	43
5.6.1	Total pressure in the backfill	43
	Geokon (App. 4\pages 159-160)	43
	Kulite (App. 4 \pages 161-162)	43
5.6.2	Suction in the backfill (App. 4\pages 163-169)	43
5.6.3	Pore water pressure in the backfill	44
	Geokon (App. 4\pages 170-171)	44
	Kulite (App. 4\pages 172-173)	44
5.6.4	Temperature in the backfill (App. 4\pages 174-178)	44
5.7	Temperature in the rock	44
5.7.1	Near hole 1 (App. 1\pages 107-109)	44
5.7.2	Near hole 2 (App. 3\page 147)	44
5.7.3	Near hole 3 (App. 2\pages 138-139)	44
5.7.4	Near hole 4 (App. 3\page 152)	45
5.8	Analyze of data from Section 1	45
5.8.1	Deposition hole 1.	45
5.8.2	Deposition hole 3.	47
5.8.3	Backfill.	50
<b>6</b>	<b>Location of instruments in Section 2</b>	<b>51</b>
6.1	Strategy for describing the position of each device in the bentonite and rock in and around the deposition holes	51
6.2	Position of each instrument in the bentonite in hole 5 (DA3551G01)	52
6.3	Position of each instrument in the bentonite in hole 6 (DA3545G01)	57
6.4	Instruments on the canister surface in holes 5-6	62
6.5	Position of temperature sensors in the rock	62
6.6	Strategy for describing the position of each device in the backfill in section 2	64
6.7	Position of each instrument in the backfill in Section 2	64
<b>7</b>	<b>Results and comments for Section 2</b>	<b>69</b>
7.1	General	69
7.2	Deposition hole 5	70
7.2.1	Total pressure	70
	Geokon (App. 5\pages 181-184)	70
	Kulite (App. 5\page 185)	70
7.2.2	Relative humidity/suction in dep. hole 5.	70
	Vaisala (App. 5\pages 186-189)	70
	Rotronic (App. 5\pages 190-194)	71
	Wescor Psychrometers (App.5\page 195)	71
7.2.3	Pore water pressure	71
	Geokon (App. 5\page 196)	71
	Kulite (App. 5\page 197)	71
7.2.4	Temperature in the buffer (App. 5\pages 198-209)	71
7.2.5	Canister power (App. 5\page 213)	72
7.2.6	Temperature on the canister surface (App. 5\pages 214-216)	72

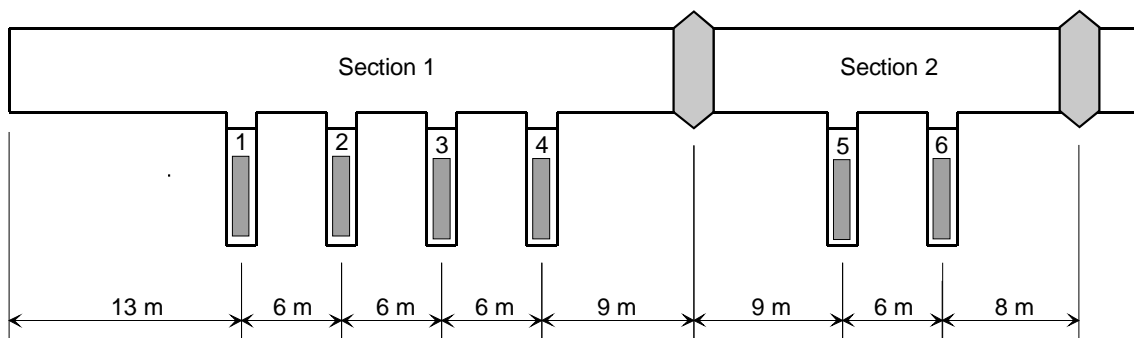
7.3	Deposition hole 6	73
7.3.1	Total pressure	73
	Geokon and Kulite (App. 6\pages 219-222)	73
7.3.2	Relative humidity/Suction	73
	Vaisala and Rotronic (App. 6\pages 223-229)	73
	Wescor Psychrometers (App. 6\page 230-234)	74
7.3.3	Pore water pressure	74
	Geokon and Kulite (App. 6\pages 235-237)	74
7.3.4	Temperature in the buffer (App. 6\pages 238-251)	74
7.3.5	Canister power (App. 6\page 255)	74
7.3.6	Temperature on the canister surface (App. 6\pages 256-258)	75
7.4	Backfill in Section 2	75
7.4.1	Total pressure	75
	Geokon (App. 7\page 261)	75
	Kulite (App. 7 \page 262)	75
7.4.2	Suction (App. 7 \pages 263-269)	76
7.4.3	Pore water pressure	76
	Geokon (App. 7\pages 270-272)	76
	Kulite (App. 7\page 273)	76
7.4.4	Temperature (App. 7\pages 274-276)	76
7.5	Temperature in the rock	76
7.5.1	Near hole 5 (App. 5\pages 210-212)	76
7.5.2	Near hole 6 (App. 7\pages 252-254)	77
7.6	Analyze of data from Section 2	77
7.6.1	Deposition hole 5.	77
7.6.2	Deposition hole 6.	79
7.6.3	Backfill	82
<b>8</b>	<b>References</b>	<b>82</b>
	<b>Appendix 1. Deposition hole 1</b>	<b>83</b>
	<b>Appendix 2. Deposition hole 3</b>	<b>113</b>
	<b>Appendix 3. Deposition holes 2 and 4</b>	<b>145</b>
	<b>Appendix 4. Backfill in Section 1</b>	<b>157</b>
	<b>Appendix 5. Deposition hole 5</b>	<b>179</b>
	<b>Appendix 6. Deposition hole 6</b>	<b>217</b>
	<b>Appendix 7. Backfill in Section 2</b>	<b>259</b>
	<b>Appendix 8. Canister displacements</b>	<b>277</b>
	<b>Appendix 9. Geo-electric monitoring</b>	<b>297</b>
	<b>Appendix 10 Stress and strain in the rock</b>	<b>341</b>
	<b>Appendix 11. Water pressure in the rock</b>	<b>375</b>
	<b>Quick guide</b>	<b>453</b>



# 1 Introduction

The Prototype Repository Test consists of two sections. The installation of the first Section of Prototype Repository was made during summer and autumn 2001 and Section 2 was installed in spring and summer 2003.

Section 1 consists of four full-scale deposition holes, copper canisters equipped with electrical heaters, bentonite blocks and a deposition tunnel backfilled with a mixture of bentonite and crushed rock and ends with a concrete plug as shown in Figure 1-1. Section 2 consists of two full-scale deposition holes with a backfilled tunnel section and ends also with a concrete plug.



**Figure 1-1.** Schematic view of the Prototype Repository.

The bentonite buffer in deposition holes 1, 3, 5 and 6, the backfill and the surrounding rock are instrumented with gauges for measuring temperature, water pressure, total pressure, relative humidity, resistivity and canister displacement. The instruments are connected to data collection systems by cables protected by tubes, which are led through the rock in watertight lead throughs.

In general the data for Section 1 in this report are presented in diagrams covering the time period 2001-09-17 to 2004-12-01. The time axis in the diagrams represent number of days from start 2001-09-17, which is the day the heating of the canister in hole 1 was started. For Section 2 the date are presented in diagrams covering the time period 2003-05-08 to 2004-12-01, where 2003-05-08 is the day when the heating of the canister in hole 5 was started.

This report consists of several parts. In chapters 2, 3, 4 and 6 a test overview with the positions of those measuring points and a brief description of the instruments are shown. In chapter 5 the measured results from all measurements in Section 1, except canister displacement, stress and strain and water pressure in the rock and resistivity in the backfill and buffer, are presented and commented. Corresponding presentations and comments for Section 2 are made in chapter 7. The diagrams of those measured results are attached in Appendix 1-7. The results and comments of the measurements of canister displacement, resistivity in the backfill, stress and strain in the rock and water pressure in the rock are presented separately in Appendix 8-11.

A quick guide to the positions of the instruments in the buffer and backfill is enclosed as the last page.

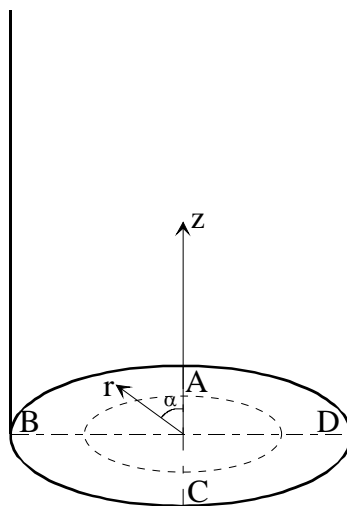


## 2 Geometry and coordinate systems

The Prototype Repository consists of two sections as shown in Figure 1-1. The geometry and the coordinate system for the sensors are different for the deposition holes and the tunnel. The temperature sensors in the rock are defined with the same coordinate system as the deposition holes.

### Deposition holes

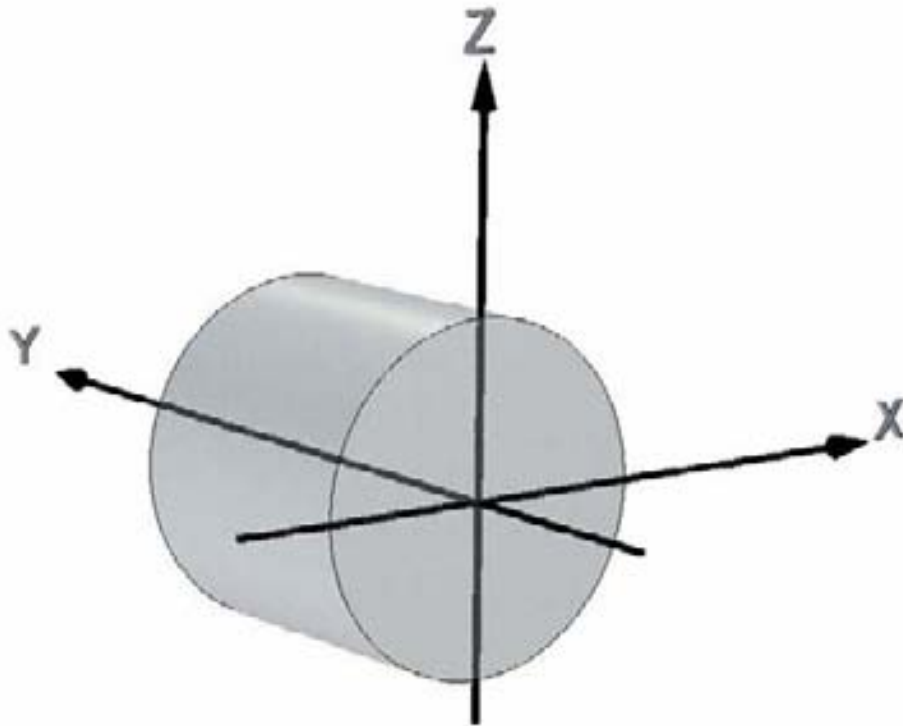
In Section 1 the deposition holes are termed 1-4 according to Figure 1-1 and in Section 2 the deposition holes are termed 5 and 6. The coordinate system for these holes is shown in Figure 2-1. With the  $z$ -axis starting from the cement casting and the angle  $\alpha$  counted anti-clockwise from direction A. Measurements are mainly made in four vertical sections A, B, C and D according to Figure 2-1. Direction A and C are placed in the tunnels axial direction with A headed against the end of the tunnel i.e. almost towards West.



**Figure 2-1.** Figure describing the instrument planes (A-D) and the coordinate system used when describing the instrument positions.

## Tunnel

The coordinate system of the backfill in the tunnel is shown in Figure 3-2. The coordinate  $y$  starts at the entrance on ground, which means that the tunnel ends at  $y = 3599, 8$ . The  $y$ -axis runs in the center of the tunnel, which means that the tunnel walls intersect the  $z$  and  $x$ -axes at  $\pm 2.5$  m. The  $z$ -coordinate is determined positive upwards and the  $x$ -coordinate is determined positive to the right when facing the end of the tunnel.



*Figure 2-2. Coordinate system of the tunnel.*



### **3 Brief description of the instruments**

The different standard instruments that are used in the buffer, backfill and rock (temperature) are briefly described in this chapter.

#### **Measurements of temperature**

##### ***Buffer, backfill and rock***

Thermocouples from Pentronic have been used to measure temperature. Measurements are done in 32 points in each instrumented hole (hole1 and hole 3). In addition, temperature gauges are built into the capacitive relative humidity sensors and some of the other sensor types as well.

##### ***Canister***

Temperature is measured on the surface of the canister with optical fiber cables. An optical measuring system called FTR (Fiber Temperature Laser Radar) is used. In Section 2 are also three thermocouples of type Pentonic installed on each canister.

#### **Measurement of total pressure in the buffer and backfill**

Total pressure is the sum of the swelling pressure and the pore water pressure. It is measured with the following instrument types:

- Geocon total pressure cells with vibrating wire transducers.
- Kulite total pressure cells with piezo resistive transducers.

#### **Measurement of pore water pressure in the buffer and backfill**

Pore water pressure is measured with the following instrument types:

- Geocon pore pressure cells with vibrating wire transducer.
- Kulite pore pressure cells with piezo resistive transducer.

#### **Measurement of the water saturation process in the buffer and backfill**

The water saturation process is recorded by measuring the relative humidity in the pore system, which can be converted to total suction (negative water pressure). The following techniques and devices are used:

- Vaisala relative humidity sensor of capacitive type. The measuring range is 0-100 % RH.
- Rotronic relative humidity sensors of capacitive type. The measuring range is 0-100 % RH.
- Wescor soil psychrometer. The sensor is measuring the dry and the wet temperature in the pore volume of the material. The measuring range is 95.5-99.6 % RH corresponding to the pore water pressure  $-0.5$  to  $-6$  MPa. Psychrometers are placed in the backfill in both sections and in the buffer in the two deposition holes in Section 2.



## 4 Location of instruments in Section 1

### 4.1 Strategy for describing the position of each device in the bentonite and rock in and around the deposition holes

The same principles are used for describing the position of all sensors in the bentonite inside the deposition holes as well as the thermocouples in the rock around the deposition holes. The principles are described in the quick guide inserted as a folded A3 page at the end of the report.

Every instrument is named with a unique name consisting of 1 letter describing the type of measurement, 2 letters describing where the measurement takes place (buffer, backfill, rock or canister), 1 figure denoting the deposition hole (1-4) and 4 figures specifying the instrument according to a separate list (see Table 2-1 to 2-10). Every instrument position is then described with three coordinates according to Figure 3-1.

The  $r$ -coordinate is the horizontal distance from the center of the hole and the  $z$ -coordinate is the height from the surface of the bottom casting of the hole (the block height is set to 500mm). The  $\alpha$ -coordinate is the angle from the vertical direction A (almost West).

Figure 4-1 shows an overview of the instruments in the buffer. The bentonite blocks are called cylinders and rings. The cylinders are numbered C1-C4 and the rings R1-R10 respectively.

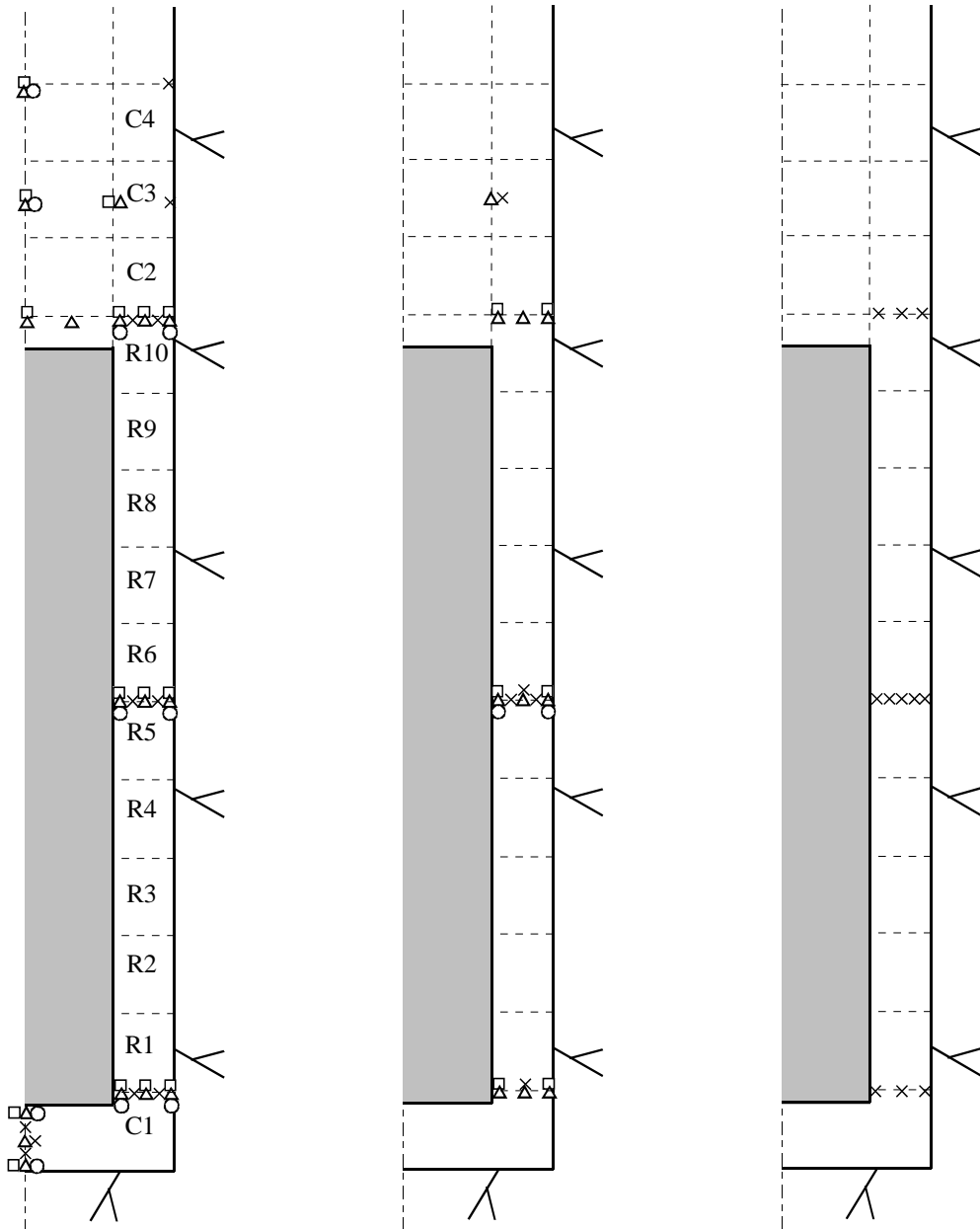
- pore water pressure + temp.
- total pressure + temp.
- × temp.
- △ relative humidity (+ temp.)

1m

A

B+C

D



**Figure 4-1** Schematic view over the instruments in four vertical sections and the block designation.

## 4.2 Position of each instrument in the bentonite in hole 1 (DA3587G01)

The instruments are located in three main levels in the blocks, 50 mm, 160 mm and 250 mm, from the upper surface. The thermocouples are mostly placed in the 50 mm level and the other gauges in the 160 mm level except for the Geokon type 1 pressure sensors and the Rotronic humidity sensors, which are placed in the 250 mm level depending on the size of the sensor house.

Exact positions of the sensors are described in Tables 4-1 to 4-4.

**Table 4-1 Numbering and position of instruments for measuring temperature (T) in the buffer in hole 1.**

Type and number	Block	Instrument position				Fabricate	Remark
		Direction	$\alpha$ degree	r m	Z m		
TBU10001	Cyl. 1	Center	270	0,050	0,054	Pentronic	
TBU10002	Cyl. 1	Center	270	0,050	0,254	Pentronic	
TBU10003	Cyl. 1	Center	270	0,050	0,454	Pentronic	
TBU10004	Cyl. 1	A	355	0,635	0,454	Pentronic	
TBU10005	Cyl. 1	A	355	0,735	0,454	Pentronic	
TBU10006	On top of the canister in hole 2					Pentronic	
TBU10007	Cyl. 1	C	175	0,685	0,454	Pentronic	
TBU10008	Cyl. 1	D	270	0,585	0,454	Pentronic	
TBU10009	Cyl. 1	D	270	0,685	0,454	Pentronic	
TBU10010	Cyl. 1	D	270	0,785	0,454	Pentronic	
TBU10011	Ring 5	A	0	0,635	2,980	Pentronic	
TBU10012	Ring 5	A	0	0,735	2,980	Pentronic	
TBU10013	Ring 5	B	90	0,585	2,980	Pentronic	
TBU10014	Ring 5	B	90	0,685	2,980	Pentronic	
TBU10015	Ring 5	B	90	0,785	2,980	Pentronic	
TBU10016	Ring 5	C	175	0,585	2,980	Pentronic	
TBU10017	Ring 5	C	175	0,685	2,980	Pentronic	
TBU10018	Ring 5	C	175	0,735	2,980	Pentronic	
TBU10019	Ring 5	D	270	0,585	2,980	Pentronic	
TBU10020	Ring 5	D	270	0,635	2,980	Pentronic	
TBU10021	Ring 5	D	270	0,685	2,980	Pentronic	
TBU10022	Ring 5	D	270	0,735	2,980	Pentronic	
TBU10023	Ring 5	D	270	0,785	2,980	Pentronic	
TBU10024	Ring 10	A	0	0,635	5,508	Pentronic	
TBU10025	Ring 10	A	0	0,735	5,508	Pentronic	
TBU10026	Ring 10	D	270	0,585	5,508	Pentronic	
TBU10027	Ring 10	D	270	0,685	5,508	Pentronic	
TBU10028	Ring 10	D	270	0,785	5,508	Pentronic	
TBU10029	Cyl. 3	A	0	0,785	6,317	Pentronic	
TBU10030	Cyl. 3	B	95	0,585	6,317	Pentronic	
TBU10031	Cyl. 3	C	185	0,585	6,317	Pentronic	
TBU10032	Cyl. 4	A	0	0,785	7,026	Pentronic	

**Table 4-2 Numbering and position of instruments for measuring total pressure (P) in the buffer in hole 1.**

Type and number	Block	Instrument position				Fabricate	Remark
		Direction	$\alpha$ degree	r m	Z m		
PBU10001	Cyl. 1	Center	0	0,000	0,000	Geokon	In cement
PBU10002	Cyl. 1	Center	0	0,100	0,504	Geokon	
PBU10003	Cyl. 1	A	5	0,585	0,504	Kulite	Vertical
PBU10004	Cyl. 1	A	5	0,685	0,504	Kulite	Vertical
PBU10005	Cyl. 1	A	5	0,785	0,504	Kulite	Vertical
PBU10006	Cyl. 1	B	95	0,635	0,504	Geokon	
PBU10007	Cyl. 1	B	105	0,735	0,504	Geokon	
PBU10008	Cyl. 1	C	185	0,635	0,504	Geokon	
PBU10009	Cyl. 1	C	195	0,735	0,504	Geokon	
PBU10011	Ring 5	A	5	0,685	2,780	Geokon I	
PBU10012	Ring 5	A	5	0,785	3,030	Kulite	In the slot
PBU10013	Ring 5	B	95	0,585	2,780	Geokon I	
PBU10014	Ring 5	B	95	0,785	2,780	Geokon I	
PBU10015	Ring 5	C	185	0,535	3,030	Geokon I	In the slot
PBU10016	Ring 5	C	185	0,825	2,870	Kulite	In the slot
PBU10017	Ring 10	Center	0	0,050	5,558	Geokon	
PBU10019	Ring 10	A	5	0,685	5,558	Kulite	Vertical
PBU10020	Ring 10	A	5	0,785	5,558	Kulite	Vertical
PBU10021	Ring 10	B	90	0,635	5,558	Geokon	
PBU10022	Ring 10	B	100	0,735	5,558	Geokon	
PBU10023	Ring 10	C	190	0,735	5,558	Geokon	
PBU10024	Ring 10	C	180	0,635	5,558	Geokon	
PBU10025	Cyl. 3	Center	0	0,050	6,317	Kulite	Vertical
PBU10026	Cyl. 3	A	5	0,585	6,567	Geokon	
PBU10027	Cyl. 4	Center	0	0,050	7,076	Kulite	Vertical

**Table 4-3 Numbering and position of instruments for measuring pore water pressure (U) in the buffer in hole 1.**

Type and number	Block	Instrument position			Fabricate	Remark	
		Direction	$\alpha$ degree	r m			Z m
UBU10001	Cyl. 1	Center	90	0,050	0,054	Kulite	
UBU10002	Cyl. 1	Center	90	0,050	0,254	Geokon	Horizontal
UBU10003	Cyl. 1	A	355	0,585	0,344	Geokon	
UBU10004	Cyl. 1	A	355	0,785	0,344	Kulite	
UBU10005	Ring 5	A	355	0,585	2,780	Geokon	
UBU10006	Ring 5	A	355	0,785	2,870	Kulite	
UBU10007	Ring 5	B	85	0,535	2,870	Kulite	In the slot
UBU10008	Ring 5	B	85	0,825	2,870	Kulite	In the slot
UBU10009	Ring 5	C	175	0,535	2,780	Geokon	In the slot
UBU10010	Ring 5	C	175	0,825	2,780	Geokon	In the slot
UBU10011	Ring 10	A	355	0,585	5,398	Kulite	
UBU10012	Ring 10	A	355	0,785	5,308	Geokon	
UBU10013	Cyl. 3	Center	90	0,050	6,317	Geokon	
UBU10014	Cyl. 4	Center	90	0,050	6,916	Geokon	

**Table 4-4 Numbering and position of instruments for measuring water content (W) in the buffer in hole 1.**

Type and number	Block	Instrument position				Fabricate	Remark
		Direction	$\alpha$ degree	r m	Z m		
WBU10001	Cyl. 1	Center	180	0,050	0,054	Rotronic	
WBU10002	Cyl. 1	Center	0	0,400	0,254	Rotronic	
WBU10003	Cyl. 1	Center	180	0,100	0,254	Rotronic	Horizontal
WBU10004	Cyl. 1	A	350	0,785	0,344	Vaisala	
WBU10005	Cyl. 1	A	350	0,685	0,344	Vaisala	
WBU10006	Cyl. 1	A	350	0,585	0,344	Vaisala	
WBU10007	Cyl. 1	B	80	0,585	0,344	Vaisala	
WBU10008	Cyl. 1	B	80	0,685	0,254	Rotronic	
WBU10009	Cyl. 1	B	80	0,785	0,254	Rotronic	
WBU10010	Cyl. 1	C	170	0,585	0,254	Rotronic	
WBU10011	Cyl. 1	C	170	0,685	0,254	Rotronic	
WBU10012	Cyl. 1	C	170	0,785	0,254	Rotronic	
WBU10013	Ring 5	A	350	0,585	2,870	Vaisala	
WBU10014	Ring 5	A	350	0,685	2,870	Vaisala	
WBU10015	Ring 5	A	350	0,785	2,870	Vaisala	
WBU10016	Ring 5	B	80	0,535	2,780	Rotronic	In the slot
WBU10017	Ring 5	B	80	0,685	2,780	Rotronic	
WBU10018	Ring 5	B	80	0,785	2,780	Rotronic	
WBU10019	Ring 5	C	180	0,535	2,870	Vaisala	In the slot
WBU10020	Ring 5	C	180	0,685	2,870	Vaisala	
WBU10021	Ring 5	C	180	0,785	2,780	Rotronic	
WBU10022	Ring 10	Center	0	0,050	5,418	Vaisala	
WBU10023	Ring 10	A	180	0,362	5,428	Vaisala	
WBU10024	Ring 10	A	350	0,585	5,398	Vaisala	
WBU10025	Ring 10	A	350	0,685	5,398	Vaisala	
WBU10026	Ring 10	A	350	0,785	5,398	Vaisala	
WBU10027	Ring 10	B	80	0,585	5,308	Rotronic	
WBU10028	Ring 10	B	80	0,685	5,308	Rotronic	
WBU10029	Ring 10	B	80	0,785	5,308	Rotronic	
WBU10030	Ring 10	C	170	0,585	5,398	Vaisala	
WBU10031	Ring 10	C	170	0,785	5,308	Rotronic	
WBU10032	Cyl. 3	Center	270	0,050	6,317	Vaisala	
WBU10033	Cyl. 3	A	350	0,585	6,317	Vaisala	
WBU10034	Cyl. 3	B	90	0,585	6,317	Vaisala	
WBU10035	Cyl. 3	C	180	0,585	6,317	Rotronic	
WBU10036	Cyl. 4	Center	180	0,050	6,916	Vaisala	
WBU10037	Cyl. 4	Center	270	0,050	6,756	Vaisala	



### 4.3 Position of each instrument in the bentonite in hole 3 (DA3575G01)

The instruments are located according to the same system as those in hole 1.

The positions of each instrument are described in Tables 4-6 to 4-10.

**Table 4-6 Numbering and position of instruments for measuring temperature (T) in the buffer in hole 3.**

Type and number	Block	Instrument position					Remark
		Direction	$\alpha$ degree	r m	Z m	Fabricate	
TBU30001	Cyl. 1	Center	270	0,050	0,095	Pentronic	
TBU30002	Cyl. 1	Center	270	0,050	0,295	Pentronic	
TBU30003	Cyl. 1	Center	270	0,050	0,445	Pentronic	
TBU30004	Cyl. 1	A	355	0,635	0,445	Pentronic	
TBU30005	Cyl. 1	A	355	0,735	0,445	Pentronic	
TBU30006	Cyl. 1	B	85	0,685	0,445	Pentronic	
TBU30007	Cyl. 1	C	175	0,685	0,445	Pentronic	
TBU30008	Cyl. 1	D	270	0,585	0,445	Pentronic	
TBU30009	Cyl. 1	D	270	0,685	0,445	Pentronic	
TBU30010	Cyl. 1	D	270	0,785	0,445	Pentronic	
TBU30011	Ring 5	A	0	0,635	2,971	Pentronic	
TBU30012	Ring 5	A	0	0,735	2,971	Pentronic	
TBU30013	Ring 5	B	90	0,585	2,971	Pentronic	
TBU30014	Ring 5	B	90	0,685	2,971	Pentronic	
TBU30015	Ring 5	B	90	0,785	2,971	Pentronic	
TBU30016	Ring 10	A	329	0,410	5,394	Pentronic	Just above canister lid
TBU30017	Ring 5	C	175	0,685	2,971	Pentronic	
TBU30018	Ring 5	C	175	0,735	2,971	Pentronic	
TBU30019	Ring 5	D	270	0,585	2,971	Pentronic	
TBU30020	Ring 5	D	270	0,635	2,971	Pentronic	
TBU30021	Ring 5	D	270	0,685	2,971	Pentronic	
TBU30022	Ring 5	D	270	0,735	2,971	Pentronic	
TBU30023	Ring 5	D	270	0,785	2,971	Pentronic	
TBU30024	Ring 10	A	0	0,635	5,504	Pentronic	
TBU30025	Ring 10	A	0	0,735	5,504	Pentronic	
TBU30026	Ring 10	D	270	0,585	5,504	Pentronic	
TBU30027	Ring 10	D	270	0,685	5,504	Pentronic	
TBU30028	Ring 10	D	270	0,785	5,504	Pentronic	
TBU30029	Cyl. 3	A	0	0,785	6,314	Pentronic	
TBU30030	Cyl. 3	B	95	0,585	6,314	Pentronic	
TBU30031	Cyl. 3	C	185	0,585	6,314	Pentronic	
TBU30032	Cyl. 4	A	0	0,785	7,015	Pentronic	

**Table 4-7 Numbering and position of instruments for measuring total pressure (P) in the buffer in hole 3.**

Type and number	Block	Instrument position in block					Remark
		Direction	$\alpha$ degree	r mm	Z mm	Fabricate	
PBU30001	Cyl. 1	Center	0	0	0	Geokon	In cement
PBU30002	Cyl. 1	Center	0	100	495	Geokon	
PBU30003	Cyl. 1	A	5	585	495	Kulite	Vertical
PBU30004	Cyl. 1	A	5	685	495	Kulite	Vertical
PBU30005	Cyl. 1	A	5	785	495	Kulite	Vertical
PBU30006	Cyl. 1	B	95	635	495	Geokon	
PBU30007	Cyl. 1	B	105	735	495	Geokon	
PBU30008	Cyl. 1	C	185	635	495	Geokon	
PBU30009	Cyl. 1	C	195	735	495	Geokon	
PBU30010	Ring 5	A	5	535	3021	Kulite	In the slot
PBU30011	Ring 5	A	5	685	2771	Geokon I	
PBU30012	Ring 5	A	5	825	3021	Kulite	In the slot
PBU30013	Ring 5	B	95	585	2771	Geokon I	
PBU30014	Ring 5	B	95	785	2771	Geokon I	
PBU30015	Ring 5	C	185	535	3021	Geokon I	In the slot
PBU30016	Ring 5	C	185	825	2971	Kulite	In the slot
PBU30017	Ring 10	Center	0	50	5556	Geokon	
PBU30018	Ring 10	A	5	585	5556	Kulite	Vertical
PBU30019	Ring 10	A	5	685	5556	Kulite	Vertical
PBU30020	Ring 10	A	5	785	5556	Kulite	Vertical
PBU30021	Ring 10	B	90	635	5556	Geokon	
PBU30022	Ring 10	B	100	735	5556	Geokon	
PBU30023	Ring 10	C	180	735	5556	Geokon	
PBU30024	Ring 10	C	190	635	5556	Geokon	
PBU30025	Cyl. 3	Center	0	50	6314	Kulite	Vertical
PBU30026	Cyl. 3	A	5	585	6564	Geokon	
PBU30027	Cyl. 4	Center	0	50	7065	Kulite	Vertical

**Table 4-8 Numbering and position of instruments for measuring pore water pressure (U) in the buffer in hole 3.**

Type and number	Block	Instrument position in block				Fabricate	Remark
		Direction	$\alpha$ degree	r mm	Z mm		
UBU30001	Cyl. 1	Center	90	50	45	Kulite	
UBU30002	Cyl. 1	Center	90	100	245	Geokon	Horizontal
UBU30003	Cyl. 1	A	355	585	335	Geokon	
UBU30004	Cyl. 1	A	355	785	335	Kulite	
UBU30005	Ring 5	A	355	585	2771	Geokon	
UBU30006	Ring 5	A	355	785	2861	Kulite	
UBU30007	Ring 5	B	85	535	2861	Kulite	In the slot
UBU30008	Ring 5	B	85	825	2861	Kulite	In the slot
UBU30009	Ring 5	C	175	535	2771	Geokon	In the slot
UBU30010	Ring 5	C	175	825	2771	Geokon	In the slot
UBU30011	Ring 10	A	355	585	5396	Kulite	
UBU30012	Ring 10	A	355	785	5306	Geokon	
UBU30013	Cyl. 3	Center	90	50	6314	Geokon	
UBU30014	Cyl. 4	Center	90	50	6910	Geokon	

**Table 4-9 Numbering and position of instruments for measuring water content (W) in the buffer in hole 3**

Type and number	Block	Instrument position				Fabricate	Remark
		Direction	$\alpha$ degree	r m	Z m		
WBU30001	Cyl. 1	Center	180	0,050	0,045	Rotronic	
WBU30002	Cyl. 1	Center	0	0,400	0,215	Rotronic	
WBU30003	Cyl. 1	Center	180	0,100	0,245	Rotronic	Horizontal
WBU30004	Cyl. 1	A	350	0,785	0,335	Vaisala	
WBU30005	Cyl. 1	A	350	0,685	0,335	Vaisala	
WBU30006	Cyl. 1	A	350	0,585	0,335	Vaisala	
WBU30007	Cyl. 1	B	80	0,585	0,335	Vaisala	
WBU30008	Cyl. 1	B	80	0,685	0,245	Rotronic	
WBU30009	Cyl. 1	B	80	0,785	0,245	Rotronic	
WBU30010	Cyl. 1	C	170	0,585	0,245	Rotronic	
WBU30011	Cyl. 1	C	170	0,685	0,245	Rotronic	
WBU30012	Cyl. 1	C	170	0,785	0,245	Rotronic	
WBU30013	Ring 5	A	350	0,585	2,861	Vaisala	
WBU30014	Ring 5	A	350	0,685	2,861	Vaisala	
WBU30015	Ring 5	A	350	0,785	2,861	Vaisala	
WBU30016	Ring 5	B	80	0,535	2,771	Rotronic	In the slot
WBU30017	Ring 5	B	80	0,685	2,771	Rotronic	
WBU30018	Ring 5	B	80	0,785	2,771	Rotronic	
WBU30019	Ring 5	C	180	0,535	2,861	Vaisala	In the slot
WBU30020	Ring 5	C	180	0,685	2,861	Vaisala	
WBU30021	Ring 5	C	180	0,785	2,771	Rotronic	
WBU30022	Ring 10	Center	180	0,050	5,416	Vaisala	
WBU30023	Ring 10	A	352	0,262	5,396	Vaisala	
WBU30024	Ring 10	A	350	0,585	5,396	Vaisala	
WBU30025	Ring 10	A	350	0,785	5,396	Vaisala	
WBU30026	Ring 10	A	350	0,685	5,396	Vaisala	
WBU30027	Ring 10	B	80	0,585	5,306	Rotronic	
WBU30028	Ring 10	B	80	0,685	5,306	Rotronic	
WBU30029	Ring 10	B	80	0,785	5,306	Rotronic	
WBU30030	Ring 10	C	170	0,585	5,396	Vaisala	
WBU30031	Ring 10	C	170	0,785	5,306	Rotronic	
WBU30032	Cyl. 3	Center	180	0,050	6,314	Vaisala	
WBU30033	Cyl. 3	A	350	0,585	6,314	Vaisala	
WBU30034	Cyl. 3	B	90	0,585	6,314	Vaisala	
WBU30035	Cyl. 3	C	180	0,585	6,314	Rotronic	
WBU30036	Cyl. 4	Center	180	0,050	6,910	Vaisala	
WBU30037	Cyl. 4	Center	270	0,050	6,750	Vaisala	

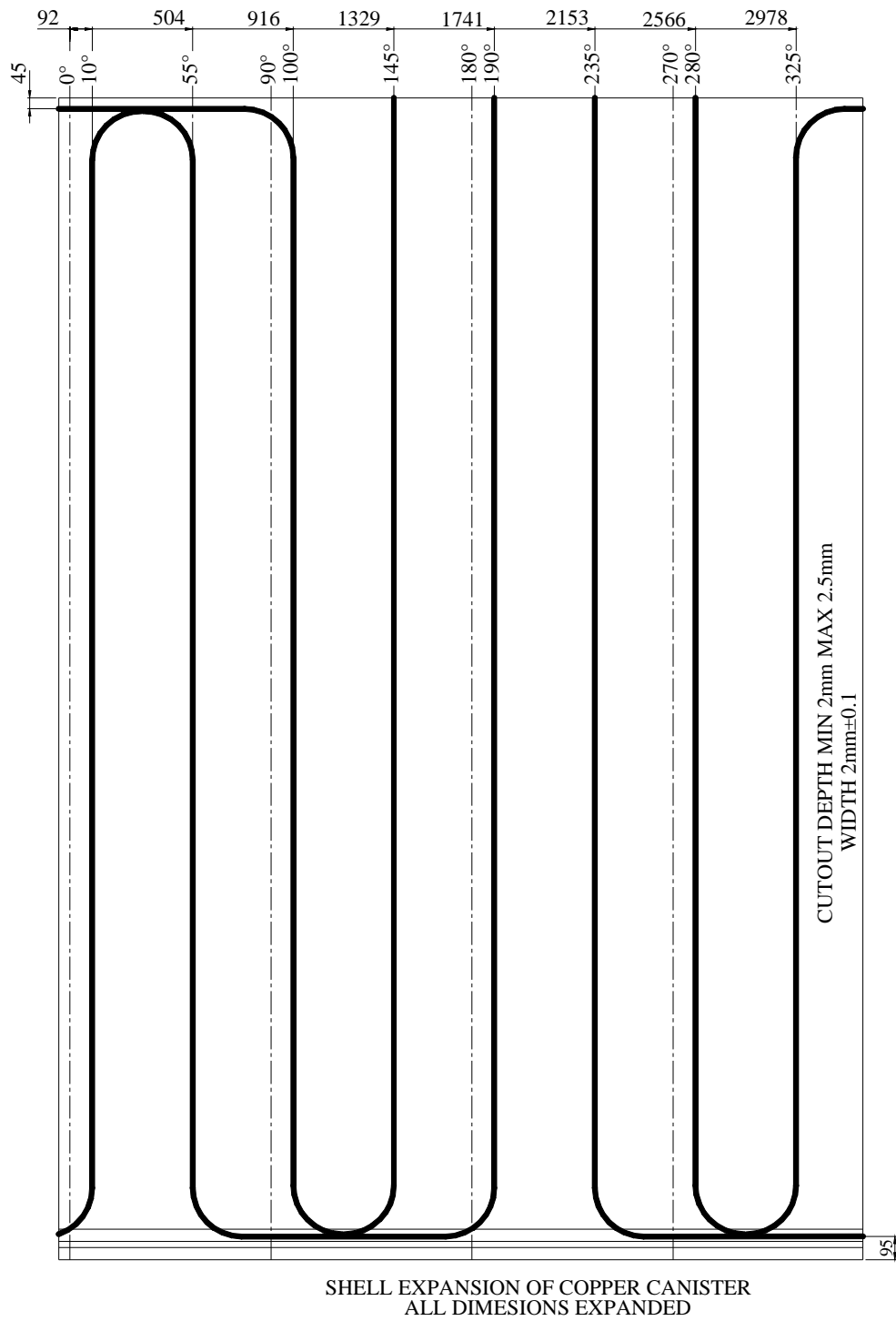
#### **4.4 Instruments on the canister surface in holes 1-4**

The canisters are instrumented with optical fiber cables on the copper surface.

Figure 4-2 shows how two optical fiber cables are placed on the canister surface. Both ends of a cable are used for measurements. This means that the two cables are used for four measurements.

With this laying the cables will enter and exit the surface at almost the same position. Curvatures are shaped as a quarter circle with a radius of 20 cm. The cables are placed in a milled out channels on the surface. The channels have a width and a depth of just above 2 mm

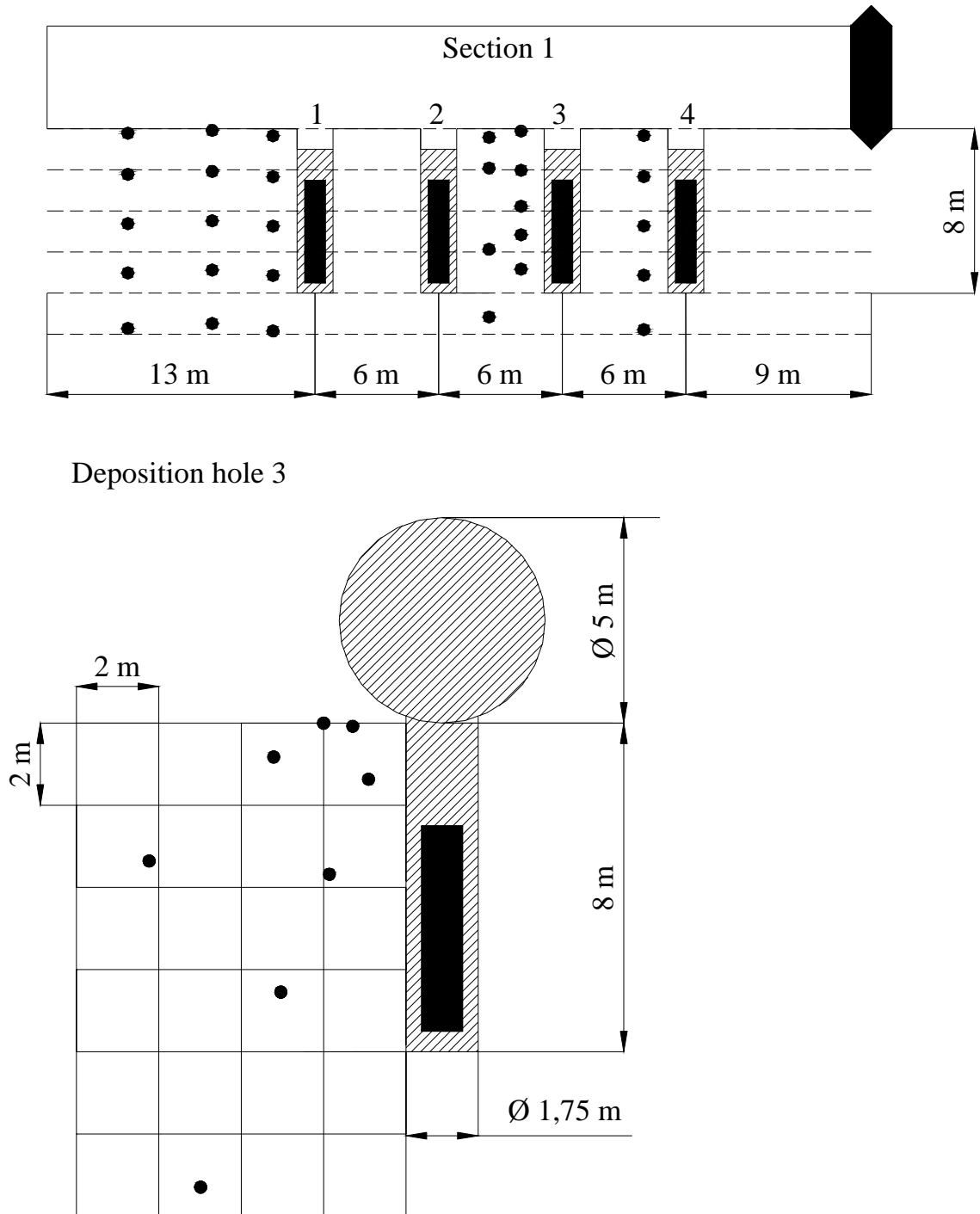
In addition to the optical cables one thermocouple (TBU 10006) is fixed to the lid of the canister in deposition hole 2 (see Table 4-1).



**Figure 4-2.** Laying of the optical fiber cables with protection tube of Inconel 625 (outer diameter 2 mm) for measurement of the canister surface temperature (surface unfolded)

#### 4.5 Position of temperature sensors in the rock

The positions of the temperature sensors in the rock are termed in the same way as the sensors in the buffer in the deposition holes. Figure 4-3 shows an overview of the temperature sensors placed in the rock. The sensors are assigned to the closest deposition hole. The positions are described in Table 4-10.



**Figure 4-3.** Overview of the temperature sensors in the rock. Length section (upper) and cross section (towards the end of the tunnel)

**Table 4-10. Numbering and position of temperature sensors in the rock**

Instrument position in rock				
Type and number	$\alpha$	r	Z	Fabricate
	degree	m	m	
Measured from DA3587G01(Hole 1)				
TROA0350	360	9,080	7,785	Pentronic
TROA0340	360	9,080	5,785	Pentronic
TROA0330	360	9,080	3,385	Pentronic
TROA0320	0	9,080	0,986	Pentronic
TROA0310	0	9,081	-1,714	Pentronic
TROA0650	360	4,990	7,922	Pentronic
TROA0640	360	4,982	5,922	Pentronic
TROA0630	360	4,972	3,522	Pentronic
TROA0620	360	4,961	1,122	Pentronic
TROA0610	360	4,951	-1,478	Pentronic
TROA1050	359	2,014	7,663	Pentronic
TROA1040	359	2,022	5,663	Pentronic
TROA1030	359	2,032	3,263	Pentronic
TROA1020	359	2,042	0,863	Pentronic
TROA1010	359	2,053	-1,837	Pentronic
Measured from DA3581G01(Hole 2)				
TROA1840	179	2,403	7,584	Pentronic
TROA1830	179	2,427	6,084	Pentronic
TROA1820	179	2,489	2,135	Pentronic
TROA1810	179	2,541	-1,165	Pentronic
Measured from DA3575G01(Hole 3)				
TROA2150	134	3,287	7,956	Pentronic
TROA2140	1	1,993	5,977	Pentronic
TROA2130	1	1,975	4,228	Pentronic
TROA2120	2	1,961	2,838	Pentronic
TROA2110	3	1,944	1,168	Pentronic
TROA1850	360	2,013	7,887	Pentronic
TROA2330	90	2,192	7,922	Pentronic
TROA2320	90	1,786	6,630	Pentronic
TROA2310	109	7,111	4,638	Pentronic
TROA2440	124	4,090	7,172	Pentronic
TROA2430	90	2,735	4,317	Pentronic
TROA2420	89	3,912	1,449	Pentronic
TROA2410	89	5,86	-3,297	Pentronic
Measured from DA3569G01 (Hole 4)				
TROA3050	359	2,013	7,665	Pentronic
TROA3040	359	2,020	5,665	Pentronic
TROA3030	358	2,030	3,265	Pentronic
TROA3020	357	2,040	0,865	Pentronic
TROA3010	357	2,051	-1,784	Pentronic

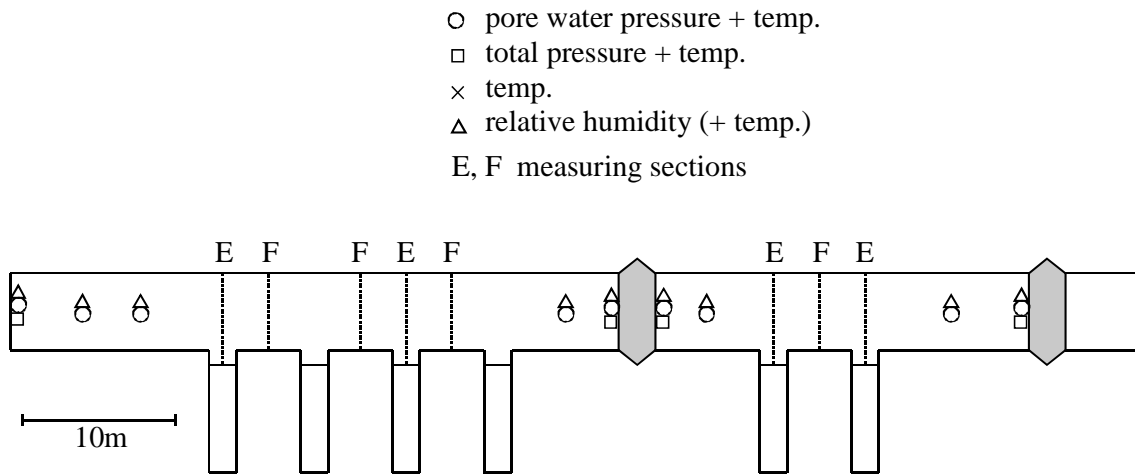


## 4.6 Strategy for describing the position of each device in the backfill in section 1

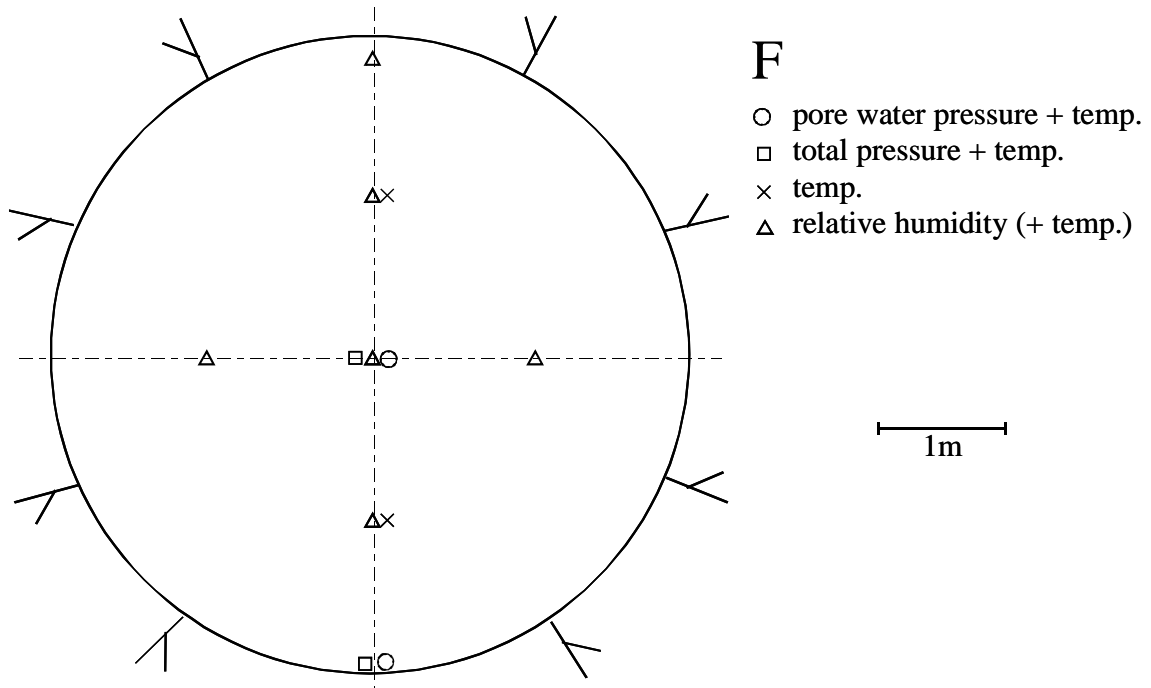
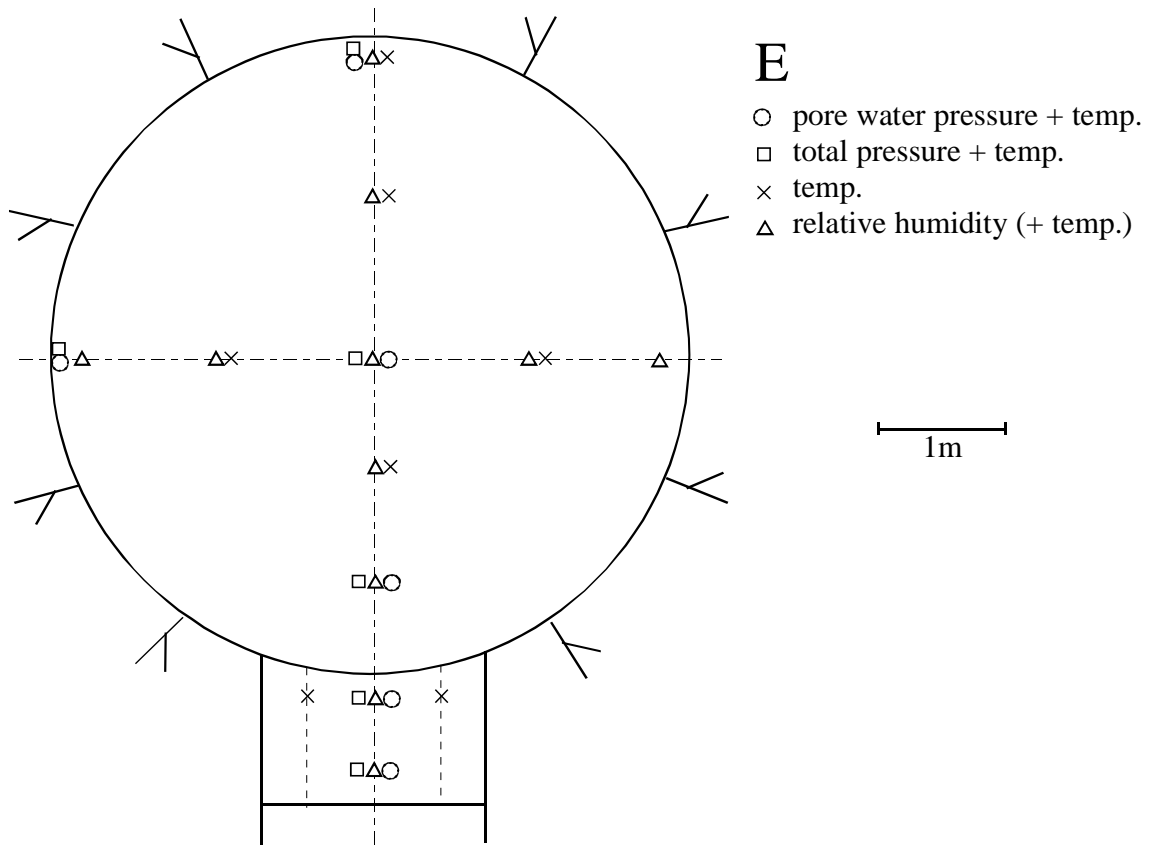
The principles of terming the instruments are described in the quick guide inserted as a folded A3 page at the end of the report.

Every instrument is named with a unique name consisting of 1 letter describing the type of measurement, 2 letters describing where the measurement takes place (buffer, backfill, rock or canister) and 5 figures specifying the instrument according to separate lists (see Tables 4-11 to 4-14). Every instrument position is then described with three coordinates according to Figure 2-2. The  $x$ -coordinate is the horizontal distance from the center of the tunnel and the  $z$ -coordinate is the vertical distance from the center of the tunnel. The  $y$ -coordinate is the same as in the tunnel coordinate system, i.e.  $y=3599$  corresponds to the end of the tunnel.

The backfill is mainly instrumented in vertical sections straight above and between the deposition holes (Figures 4-4 and 4-5).



**Figure 4-4** Schematic view over the instrumentation of the backfill



*Figure 4-5 Schematic view over the sensors positions in the different sections.*

## 4.7 Position of each instrument in the backfill

The positions of each instrument are described in Tables 4-11 to 4-14.

**Table 4-11 Numbering and position of instruments for measuring temperature (T) in the backfill.**

Type and number	Instrument position			Fabricate	Remark	
	Section	x	z			y
		m	m			m
TBA10001	E, over dep.hole 1	-1,3	-0,1	3 587	Pentronic	
TBA10002	E, over dep.hole 1	0,1	1,3	3 587	Pentronic	
TBA10003	E, over dep.hole 1	0,0	-0,8	3 587	Pentronic	
TBA10004	E, over dep.hole 1	-0,5	-2,6	3 587	Pentronic	
TBA10005	E, over dep.hole 1	0,5	-2,6	3 587	Pentronic	
TBA10006	E, over dep.hole 1	-0,1	2,3	3 587	Pentronic	
TBA10007	E, over dep.hole 1	1,3	-0,1	3 587	Pentronic	
TBA10008	F, between dep.hole 1 and 2	0,0	1,3	3 584	Pentronic	
TBA10009	F, between dep.hole 1 and 2	-0,1	-1,3	3 584	Pentronic	
TBA10010	F, between dep.hole 2 and 3	0,0	1,2	3 578	Pentronic	
TBA10011	F, between dep.hole 2 and 3	0,0	-1,2	3 578	Pentronic	
TBA10012	E, over dep.hole 3	-0,1	2,3	3 575	Pentronic	
TBA10013	E, over dep.hole 3	0,0	1,3	3 575	Pentronic	
TBA10014	E, over dep.hole 3	0,0	-0,9	3 575	Pentronic	
TBA10015	E, over dep.hole 3	-0,5	-2,6	3 575	Pentronic	
TBA10016	E, over dep.hole 3	0,5	-2,6	3 575	Pentronic	
TBA10017	E, over dep.hole 3	-1,3	0,0	3 575	Pentronic	
TBA10018	E, over dep.hole 3	1,3	0,0	3 575	Pentronic	
TBA10019	F, between dep.hole 3 and 4	0,0	1,2	3 572	Pentronic	
TBA10020	F, between dep.hole 3 and 4	0,0	-1,3	3 572	Pentronic	

**Table 4-12 Numbering and position of instruments for measuring total pressure (P) in the backfill.**

Type and number	Instrument position			Fabricate	Remark
	Section	x	z		
		m	m	m	
PBA10001	Inner part	0,2	0,1	3589	Kulite
PBA10002	E, over dep.hole 1	0,0	0,0	3587	Geokon
PBA10003	E, over dep.hole 1	0,0	-1,8	3587	Geokon
PBA10004	E, over dep.hole 1	0,0	-2,6	3587	Geokon
PBA10005	E, over dep.hole 1	0,0	-3,1	3587	Kulite
PBA10006	E, over dep.hole 1	-2,3	0,1	3587	Kulite
PBA10007	E, over dep.hole 1	0,2	2,3	3587	Kulite
PBA10008	F, between dep.hole 1 and 2	0,0	0,0	3584	Geokon
PBA10009	F, between dep.hole 1 and 2	-0,1	-1,8	3584	Geokon
PBA10010	F, between dep.hole 2 and 3	0,0	-0,2	3578	Kulite
PBA10011	F, between dep.hole 2 and 3	0,0	-2,3	3578	Kulite
PBA10013	E, over dep.hole 3	0,0	-1,8	3575	Kulite
PBA10015	E, over dep.hole 3	0,0	-3,1	3575	Geokon
PBA10016	E, over dep.hole 3	-2,3	0,0	3575	Geokon
PBA10017	E, over dep.hole 3	0,0	0,0	3575	Geokon
PBA10018	F, between dep.hole 3 and 4	0,0	0,0	3572	Geokon
PBA10019	F, between dep.hole 3 and 4	0,0	-2,3	3572	Geokon
PBA10020	In front of plug	0,0	0,0	3561	Kulite

**Table 4-13 Numbering and position of instruments for measuring pore water pressure (U) in the backfill.**

Type and number	Instrument position			Fabricate	Remark
	Section	x	z		
		m	m	m	
UBA10001	Inner part	-0,2	-0,1	3589	Kulite
UBA10002	Inner part	0,0	0,0	3592	Geokon
UBA10003	Inner part	-0,2	-0,1	3590	Geokon
UBA10004	E, over dep.hole 1	0,0	-0,1	3587	Geokon
UBA10005	E, over dep.hole 1	-0,2	-1,8	3587	Kulite
UBA10006	E, over dep.hole 1	0,1	-2,6	3587	Kulite
UBA10007	E, over dep.hole 1	0,4	-3,2	3587	Kulite
UBA10008	E, over dep.hole 1	-2,3	0,0	3587	Geokon
UBA10009	E, over dep.hole 1	0,0	2,3	3587	Geokon
UBA10010	F, between dep.hole 1 and 2	0,0	0,0	3584	Kulite
UBA10011	F, between dep.hole 1 and 2	0,1	-1,8	3584	Kulite
UBA10012	F, between dep.hole 2 and 3	0,0	-0,2	3578	Kulite
UBA10013	F, between dep.hole 2 and 3	0,0	-2,3	3578	Kulite
UBA10014	E, over dep.hole 3	0,0	0,0	3575	Kulite
UBA10015	E, over dep.hole 3	0,0	-1,8	3575	Geokon
UBA10016	E, over dep.hole 3	0,3	-2,6	3575	Geokon
UBA10017	E, over dep.hole 3	-0,1	-3,1	3575	Geokon
UBA10018	E, over dep.hole 3	-2,3	0,0	3575	Geokon
UBA10019	E, over dep.hole 3	0,0	0,0	3575	Geokon
UBA10020	F, between dep.hole 3 and 4	0,0	0,0	3572	Kulite
UBA10021	F, between dep.hole 3 and 4	0,0	-2,3	3572	Kulite
UBA10022	In front of plug	0,0	0,0	3565	Kulite
UBA10023	In front of plug	0,1	0,0	3562	Kulite

**Table 4-14 Numbering and position of instruments for measuring relative humidity (W) in the backfill.**

Type and number	Instrument position			Fabricate	Remark
	Section	x	z		
		m	m	m	
WBA10001	Inner part	0,0	0,0	3589	Wescor
WBA10002	Inner part	0,0	0,0	3592	Wescor
WBA10003	Inner part	0,1	-0,1	3590	Wescor
WBA10004	E, over dep.hole 1	0,3	2,3	3587	Wescor
WBA10005	E, over dep.hole 1	0,0	1,3	3587	Wescor
WBA10006	E, over dep.hole 1	0,0	0,1	3587	Wescor
WBA10007	E, over dep.hole 1	0,1	-0,8	3587	Wescor
WBA10008	E, over dep.hole 1	0,0	-1,7	3587	Wescor
WBA10009	E, over dep.hole 1	-0,1	-2,6	3587	Wescor
WBA10010	E, over dep.hole 1	-0,5	-3,1	3587	Wescor
WBA10011	E, over dep.hole 1	-2,3	-0,1	3587	Wescor
WBA10012	E, over dep.hole 1	-1,3	0,0	3587	Wescor
WBA10013	E, over dep.hole 1	1,3	0,0	3587	Wescor
WBA10014	E, over dep.hole 1	2,3	0,0	3587	Wescor
WBA10015	F, between dep.hole 1 and 2	0,0	1,3	3584	Wescor
WBA10016	F, between dep.hole 1 and 2	0,0	2,3	3584	Wescor
WBA10017	F, between dep.hole 1 and 2	0,0	0,0	3584	Wescor
WBA10018	F, between dep.hole 1 and 2	0,0	-1,3	3584	Wescor
WBA10019	F, between dep.hole 1 and 2	-1,3	0,0	3584	Wescor
WBA10020	F, between dep.hole 1 and 2	1,3	0,0	3584	Wescor
WBA10021	F, between dep.hole 2 and 3	0,0	2,3	3578	Wescor
WBA10022	F, between dep.hole 2 and 3	0,0	1,2	3578	Wescor
WBA10023	F, between dep.hole 2 and 3	0,0	-0,2	3578	Wescor
WBA10024	F, between dep.hole 2 and 3	0,0	-1,2	3578	Wescor
WBA10025	F, between dep.hole 2 and 3	-1,3	0,0	3578	Wescor
WBA10026	F, between dep.hole 2 and 3	1,3	0,0	3578	Wescor
WBA10027	E, over dep.hole 3	0,0	2,5	3575	Wescor
WBA10028	E, over dep.hole 3	0,0	1,3	3575	Wescor
WBA10029	E, over dep.hole 3	0,0	0,0	3575	Wescor
WBA10030	E, over dep.hole 3	0,0	-0,9	3575	Wescor
WBA10031	E, over dep.hole 3	0,0	-1,6	3575	Wescor
WBA10032	E, over dep.hole 3	-0,3	-2,6	3575	Wescor
WBA10033	E, over dep.hole 3	0,1	-3,1	3575	Wescor
WBA10034	E, over dep.hole 3	-2,3	0,0	3575	Wescor
WBA10035	E, over dep.hole 3	-1,3	0,0	3575	Wescor
WBA10036	E, over dep.hole 3	1,3	0,0	3575	Wescor
WBA10037	E, over dep.hole 3	2,3	0,0	3575	Wescor
WBA10038	F, between dep.hole 3 and 4	0,0	2,3	3572	Wescor
WBA10039	F, between dep.hole 3 and 4	0,0	1,2	3572	Wescor
WBA10040	F, between dep.hole 3 and 4	0,0	0,0	3572	Wescor
WBA10041	F, between dep.hole 3 and 4	0,0	-1,3	3572	Wescor
WBA10042	F, between dep.hole 3 and 4	-1,3	0,0	3572	Wescor
WBA10043	F, between dep.hole 3 and 4	1,3	0,0	3572	Wescor
WBA10044	In front of plug	0,0	0,0	3565	Wescor
WBA10045	In front of plug	-0,1	0,0	3562	Wescor

# 5 Results and comments for Section 1

## 5.1 General

In this chapter short comments on general trends in the measurements are given. Sensors that are not delivering reliable data or no data at all are noted and comments on the data collection in general are given.

The heating of the canister in hole1 started with an applied constant power of 1800 W at 010917. This date is also marked as start date. The backfilling started 010903 and was finished 011120 and the plug was cast at 011214. In order to simulate the radioactive decay, the power was decreased 20 W one year after start of the first heater. At the beginning of September 2004 the power was decreased with about 30 W to 1710 W in deposition holes 1-4. Table 5-1 shows some important dates for section 1. At the beginning of November the drainage of the inner part of Section 1 and the drainage trough the outer plug were closed. At the beginning of December damages were observed on one canister in Section 1 (No 1) and one in Section 2 (No 6) probably due to high water pressure in the buffer and backfill. It was then decided to switch off the power to all canisters. This was done on December 2. The drainage of the tunnel was opened on December 6 and investigations on the damaged canisters were initialized. The power to all the canisters, except for canister 2, was on December 15 switched on. The damages on canister 2 were so severe that it was impossible to apply any power in this canister. The drainage of the tunnel was kept open.

**Table 5-1. Key dates for section 1**

Activity	Date
Start backfilling	3/9 2001
Start heating canister 1	17/9 2001
Start heating canister 2	24/9 2001
Start heating canister 3	11/10 2001
Start heating canister 4	22/10 2001
Finish backfilling	20/11 2001
Plug casting	14/12 2001
Decreased power (-20 W)	17/9 2002
Decreased power (-40 W)	5/9 2003
Decreased power (-30 W)	8/9 2004
The drainage of tunnel was closed	1/10 2004
The power to all canisters was switched off	2/12 2004
The drainage of the tunnel was opened	6/12 2004
The power to the canisters was switched on	15/12 2004
Decreased power (-30 W)	2/12 2005
A packer installed in the rock was broken	18/5 2006

Beside the above reported power reductions a change in power was made June 23 2003 due to additional calculations of the power from measurement of the energy. The power of the canisters was adjusted to 1800 W. The most significant change was made for canister 2 (See section 5.4.1 and Appendix 3 page 138).

About 212 out of 363 sensors (excluding water pressure sensors in the rock and the displacement sensors for the canister) are out of order, the majority being RH-sensors that fail at water saturation and thermocouples in deposition hole 3.

The measured processes were slow up to about 20 days after the drainage of the tunnel was closed. Very small changes of the measured parameters occurred up to that date. After that the readings from some of the total and pore pressure sensors placed in the buffer reacted strongly (quick increase in pressure). Also the total and pore pressure sensors placed in the backfill recorded high pressures caused by the closing of the drainage. After the reopening of the drainage of the tunnel, both the pore pressures and the total pressures were stabilized on almost the same level as before the closing of the drainage. At the end of this measuring period the both the total pressure sensors and the pore pressure sensors are measuring an increase in pressure. This is caused by a failure in one packer placed in the rock at the inner part of the tunnel causing an increase in out flow of water from the inner section from about 1,5 l/min to more than 9 l/min.

So far hole 1 has been strongly wetted but very little wetting is observed in hole 3. A slow but obvious wetting of the backfill is noted until about 20 days after the closing of the drainage. After that a strong increase of the wetting rate was monitored by several psychrometers. The measurement of the temperature on the canister surface with the optical system has stopped functioning.

## **5.2 Deposition hole 1**

### **5.2.1 Total pressure**

#### **Geokon (App. 1\pages 85-87)**

The measured pressure range is from 0 to 8.5 MPa. The highest pressure is indicated from the peripheral sensors in the bottom block (C1). Four sensors in block R5 and block R10 yielded a high increase in total pressure when the drainage of the tunnel was closed. Most of the sensors yielded a drop in pressure when the heaters were switched off and the drainage of the tunnel was opened again and an increase in pressure when the heaters were switched on again.

Thirteen sensors are out of order.

#### **Kulite (App. 1\page 88)**

The highest pressure 7 MPa is indicated from the peripheral sensor (PBU 10012) in block R5. Three of the installed sensors indicated a rapid increase in pressure when the drainage of the tunnel was closed followed by a drop in pressure when the power was switched off and the drainage was reopened. After the power was switched on the pressure increased to the same level as before the closing of the drainage.

Two sensors were not installed and five of the installed sensors are out of order.



### **5.2.2 Relative humidity**

#### **Vaisala (App. 1\pages 89-92)**

Since temperature is also measured with all relative humidity sensors, the diagrams include those measured temperatures. The temperature measurements start at about 16 degrees while the RH measurements start at about 70 %RH.

The relative humidity has not changed very much during the last 6 months, except for the sensors placed above the canister (in Cylinder 3 and 4) which are indicating a slowly wetting. The temperature measurements were effected when the power to the heaters was switched off but reached similar levels as before when the power was switched on again.

Thirteen sensors are out of order, most of them due to water saturation.

#### **Rotronic (App. 1\pages 93-97)**

All Rotronic sensors placed between the canister and the rock show RH higher than 90%.

Two of the sensors placed in the central part of block C1 are indicating a drying of the bentonite (decreasing in RH from about 75%)

Sixteen sensors are out of order, most of them due to water saturation.

### **5.2.3 Pore water pressure**

#### **Geokon (App. 1\page 98)**

The highest pressures 500-1450 kPa are measured near the canister surface in block R5 (UBU10005) and in the periphery of block R5 (UBU10010). One sensor in block C1 is also recording an increasing pressure (UBU1003) while the rest of the sensors are measuring very low pressures.

Two sensors are out of order.

#### **Kulite (App. 1\page 99)**

A rather high water pressure is noted from three sensors located in block R5 (1200 – 3500 kPa). The pore pressure measured with two of the sensors reacted strongly during the period when the drainage of the tunnel was closed and during the period when the power to the canister was switched off.

Two sensors are out of order.

### **5.2.4 Temperature in the buffer (App. 1\pages 100-106)**

The latest measured temperature ranges from 29.0 °C (in the periphery of the upper bentonite cylinder C4) to 69.0 °C in the center close to the canister. The highest temperature gradient is 0.57 °C /cm (block R5).

Twenty-seven sensors are out of order.

The temperature in the buffer is also measured with the Geokon sensors (from day 1350). The maximum temperature recorded with these sensors is about 63 °C at the end of this measuring period (PBU10002 placed in the center of block C1 close to the canister).

### **5.2.5 Canister power in dep. hole 1 (App. 1\page 110)**

The power of the canister in hole 1 has been kept constant during one year at 1800 W since the start 010917. After one year the power was decreased with about 20 W. After another year the power was decreased with about 40 W. The next reduction of power was made at the beginning of September year 2004 (about 30 W). After this reduction the power of the canister in hole 1 was about 1710 W. During the period between December 6 and December 15 the power to the canister was switched off. After that period the power was adjusted to about 1710 W again. At the beginning of December 2005 the power was decreased with 30 W to about 1680 W.

### **5.2.6 Temperature on the canister surface (App. 1\pages 111-112)**

The first diagram shows the maximum temperature, measured with the optical cables placed on the surface of the canister, plotted as function of time. The maximum measured temperature on the canister surface is about 75 °C. With no damages on the optical cables this plot should have four curves. Only one curve with relevant values is presented here up to December 24 which indicates that the optical cables are damaged. The second diagram shows the distribution of the temperature along the optical cables at December 1 2004. The length of the cables on the canister surface is about 20 m. The variation of a few degrees is caused by the difference in temperature in the center and ends of the canister. At December 15 the optical system for measuring the temperature on this canister stopped functioning.

## **5.3 Deposition hole 3**

### **5.3.1 Total pressure**

#### **Geokon (App. 2\pages 115-117)**

Most of the sensors placed in block C1 and block R10 yielded an increase in total pressure when the drainage of the tunnel was closed.

The total pressure measured in this deposition hole is significantly lower than those measured in deposition hole 1. The maximum pressure registered so far is 4 MPa (PBU30023). This sensor is placed in block R10. Four out of 16 sensors have measured a pressure higher than 500 kPa.

Ten sensors are out of order.

#### **Kulite (App. 2\pages 118-119)**

The highest pressure, 1.8 MPa, is indicated from the peripheral placed sensors in block R10. The sudden change in pressure that occurred after about 180 days was probably caused by early data logger problems.

Ten sensors are out of order

### **5.3.2 Relative humidity**

#### **Vaisala (App. 2\pages 120-123)**

A significant drying of the bentonite close to the top of the canister was observed by the two sensors WBU30022 and WBU30023. After the closing of the drainage both sensors indicated a significant increasing in relative humidity. An increased wetting of the bentonite can be observed by sensors place in block R10 between the canister and the rock. One sensor placed in block R5 showed an increase in relative humidity from about 70% to 82% after the closing of the drainage. The changes in the relative humidity in the buffer measured by the rest of the sensors are very small.

Fourteen sensors are out of order.

#### **Rotronic (App. 2\pages 124-128)**

All Rotronic sensors in hole 3 have failed or increased the measured RH to 100%. The reason for this is unclear. Since there are no other signs of strong wetting, malfunction are more probable than strong wetting. One sensor (WBU30016) placed close to the canister in block R5 was indicating a drying of the bentonite until it failed.

Sixteen sensors are at present out of order.

### **5.3.3 Pore water pressure**

#### **Geokon (App. 2\page 129)**

All sensors yield very low pressure except for one sensor below the heater that yields a sudden increase to 220 kPa (questionable).

#### **Kulite (App. 2\page 130)**

UBU30004 yields a pressure of 440 kPa and this sensor is placed near the rock surface at the bottom of the deposition hole. The other sensors yield very low pressures.

### **5.3.4 Temperature in the buffer (App. 2\pages 131-137 and 140)**

The measured temperature ranges from 38 °C (in the periphery of the upper bentonite cylinder C4) to a temperature of 83.2 °C in the center close to the canister. These measurements are from the period just before the power to the canisters were switched off. The highest temperature gradient is 0.59 °C/cm (block R5). There have appeared some problems with some data scan units, which explains the noise in some curves.

30 sensors are out of order.

The temperature in the buffer is also measured with the Geokon sensors (from day 1350). The maximum temperature recorded with these sensors is about 82 °C at the end of this measuring period (PBU30002 placed in the center of block C1 close to the canister).

### **5.3.5 Canister power (App. 2\page 141)**

The power of the canister in hole 3 has been kept constant at 1800 W from the start 011011 until 020917, when the power was decreased with about 20 W. Some initial problems have been overcome. The power has been stepwise decreased according to Table 5-1. During the period between December 6 and December 15 the power of all canisters was switched off. After that period the power was adjusted to about 1710 W. At the beginning of December 2005 the power was decreased with 30 W to about 1680 W.

### **5.3.6 Temperature on the canister surface (App. 2\pages 142-143)**

The first diagram shows the maximum temperature plotted as a function of time. The maximum measured temperature on the canister surface was about 100 °C just before the power to the canisters was switched off. The temperature recovered, but only to about 93 °C after the power was switched on again and after that a slightly decrease in temperature was measured until the sensor stopped functioning at the end of August 2005. The second diagram shows the distribution of the temperature along the cables. See also chapter 5.2.6.

## **5.4 Deposition hole 2**

### **5.4.1 Canister power (App. 3\page 148)**

The power of the canister in hole 2 has been kept constant at 1800 W from the start 010924 until 020917, when the power was decreased with about 20 W. After two years (September 2003) the power was decreased with about 40 W to 1740 W. The interruption in the curve between days 409 and 456 is caused by data collection problems. At the beginning of September 2004 the power was decreased with about 40 W to 1710 W. Since permanent damages on the heaters in the canister were observed on December 1 the power to this canister has been switched off and not been restarted.

### **5.4.2 Temperature on the canister surface (App. 3\pages 149-150)**

See chapter 5.2.6. The maximum measured temperature on the canister surface is at present 91 °C. The reason for the unexpected increase in temperature after 450 days is the difficulties with the measurement of the power (see chapter 5.2.5). The actual power at that time was probably higher than 1800 W. After the power was switched off the temperature on the canister surface was stabilized on about 30 °C. The sensor stopped give reliable data at the beginning of June 2005.

## **5.5 Deposition hole 4**

### **5.5.1 Canister power (App. 3\page 153)**

The power of the canister in hole 3 has been kept constant at 1800 W from the start 011011 until 020917, when the power was decreased with about 20 W. Some initial problems have been overcome. The power has been stepwise decreased according to Table 5-1. During the period between December 6 and December 15 the power of all canisters was switched off. After that period the power was adjusted to about 1710 W. At the beginning of December 2005 the power was decreased with 30 W to about 1680 W.

### **5.5.2 Temperature on the canister surface (App. 3\pages 154-155)**

See chapter 5.2.6. The maximum measured temperature on the canister surface after the power was switched on again was 88 °C. The sensor stopped give reliable data at the beginning of April 2005.

## **5.6 Backfill in Section1**

### **5.6.1 Total pressure in the backfill**

#### **Geokon (App. 4\pages 159-160)**

All these sensors yielded high increase in total pressure in connection with closing of the tunnel drainage. The maximum measured pressure was about 2.5 MPa. After the opening of the drainage the total pressure was stabilized on the same level as before the closing of the drainage (maximum pressure about 0.2 MPa). At around the 20<sup>th</sup> of April 2006, a packer placed in a borehole in Section I of the tunnel started to leak resulting in an increase of water drained out from the inner section from about 1.5 l/min to about 9 l/min. The damaged packer caused also an increase in the measured total pressure of about 300 kPa (around day 1660).

One sensor is out of order.

#### **Kulite (App.4 \pages 161-162)**

These measurements yielded rather small increase in total pressure until the drainage of the tunnel was closed. The maximum pressure recorded with PBA10013 was about 500 kPa. The sensor stopped functioning during a period of about 100 day after the rapid increase in pressure when the tunnel drainage was closed. Sensor PBA10013 is placed 1.7 m above the bentonite surface in hole 3.

All sensors are out of order.

### **5.6.2 Suction in the backfill (App. 4\pages 163-169)**

The suction in the backfill is measured with Wescor psychrometers. The steady but slow wetting (decrease in suction) observed in about 50% of the sensors continues. 7 sensors close to the roof and walls of the tunnel and one sensor just above the buffer in hole 1 indicate fast wetting that has gone close to water saturation (less than 1000 kPa suction). Also the sensor placed just inside the plug has reached a suction value that indicates saturation. In connection with the closing of the drainage, a very rapid decrease in suction was recorded by the installed psychrometers. Six of these sensors placed in the central part of the tunnel section yielded an increase in suction, after the reopening of the drainage, to the same level as before the closing. Seven of the sensors measured a decrease in suction after the packer was damaged.

Many of these sensors have stopped giving reliable values due to high water saturation of the backfill.

### **5.6.3 Pore water pressure in the backfill**

#### **Geokon (App. 4\pages 170-171)**

All these sensors yielded high increase in pore pressure when the drainage of the tunnel was closed. Many of the sensors recorded pressures up to 2.3 MPa. After the opening of the drainage the pore pressure was stabilized at low pressures (below 0.1 MPa). Also these sensors reacted when the packer was broken by measuring an increase in pore pressure of about 200 kPa.

#### **Kulite (App. 4\pages 172-173)**

Also some of these sensors recorded very high water pressure after the closing of the drainage. The still functioning sensors measured an increase in pore pressure of about 200 kPa at the time when the packer installed in the rock was broken. Eight sensors are out of order.

### **5.6.4 Temperature in the backfill (App. 4\pages 174-178)**

The temperature in the backfill ranges from 18 to 35 degrees. The highest temperature is as expected measured above the buffer in hole 3 Also these sensors reacted when the packer was broken (a decrease in temperature).

## **5.7 Temperature in the rock**

### **5.7.1 Near hole 1 (App. 1\pages 107-109)**

The maximum temperature measured in the rock is 38.6 °C. This temperature was measured with the thermocouple TROA1030 located 2.038 m from the center of the canister in deposition hole 1. The temperature in the rock close to the deposition hole decreased when the power to the canisters was switched off but increased again when the power was switched on to a temperature about 1 °C lower than before the power was switched off.

### **5.7.2 Near hole 2 (App. 3\page 147)**

The maximum temperature in the rock (46.8 °C) was measured by TROA1820 located 2.490 m from the center of the canister in deposition hole 2 just before the power to the canisters was switched off. Since no power is applied to this canister anymore the temperature in the rock around the deposition hole is continuing to decrease.

### **5.7.3 Near hole 3 (App. 2\pages 138-139)**

The maximum temperature in the rock (48.8 °C) was measured by TROA2120 located 1.967 m from the center of the canister in deposition hole 3 just before the power to the canisters was switched off. Although the power was switched on again the temperature around the deposition hole is continuing to drop. This is most obvious for the sensors installed in the direction towards deposition hole 2.

#### **5.7.4 Near hole 4 (App. 3\page 152)**

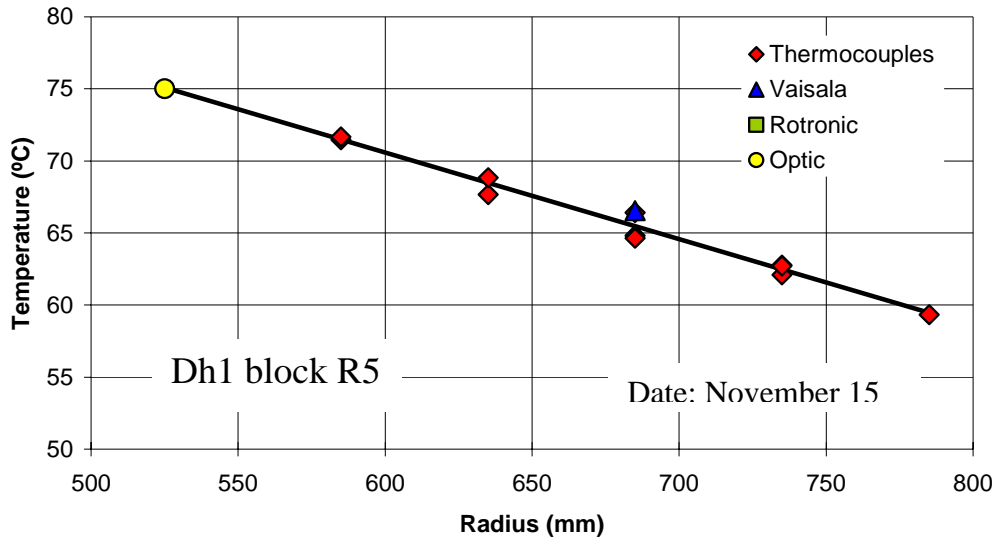
The maximum temperature in the rock (46.5 degrees) is measured by TROA3030 located 2.034 m from the center of the canister in deposition hole 4. Also for this deposition hole there was a drop in the temperature in the rock when the power was switched off. After the power was switched on again the temperature in the rock increased to almost the same level as before the power was switched off.

### **5.8 Analyze of data from Section 1**

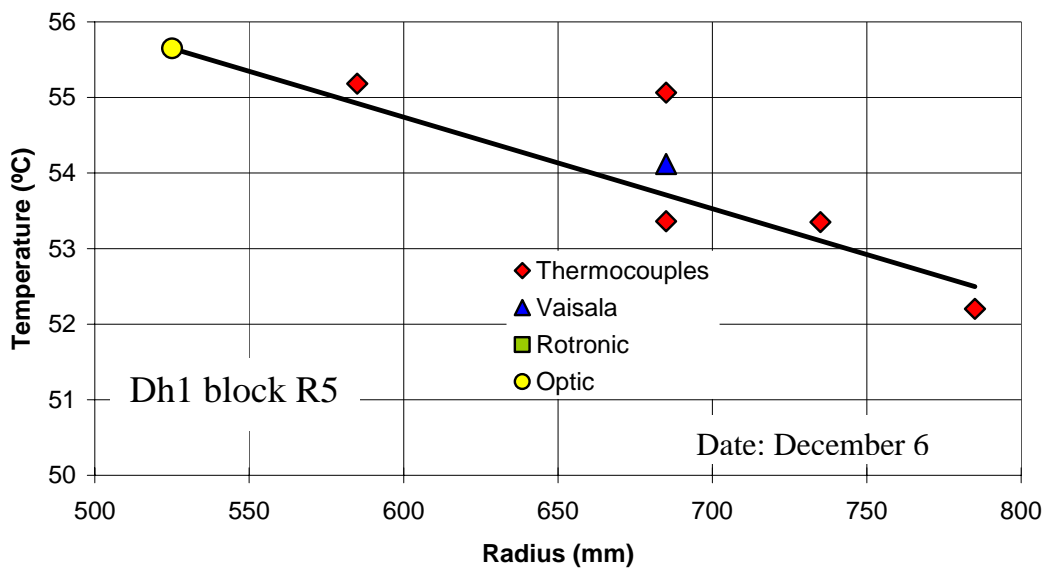
#### **5.8.1 Deposition hole 1**

Before the drainage of the tunnel was closed and the power of the canister was switched off the saturation of the buffer at mid height of the canister in block R5 indicated both by the relative humidity sensors and total pressure sensors to be high even close to the canister (PBU10015). This was not changed when the drainage was opened and power of the canister was switched on again. The degree of saturation in the solid blocks both under (block C1) and above the canister (Blocks C2-C4) is much lower but a slow increase with the time of relative humidity and swelling pressure is indicated by the sensors. This trend is continuing with the same rate after the drainage was opened and the power was switched on.

In Figure 5-1 the temperature in the buffer is plotted as function of the radius from the center of the deposition hole. The measurements are made with different type of sensors in block R5 (at mid height of the canister). A straight line is fitted to the measured values. The temperature gradient is determined from the fitted line in the figure. This gradient together with the temperature on the canister surface and the temperature in the buffer close to the outer radius of the ring shaped block ( $r = 785$  mm) are plotted as function of time in Figure 5-3. The shaded part of the plot represents the time when the power to the canister was switched off at the beginning of December 2004. The plot shows that the temperature after this is somewhat lower than before, probably due to the fact that no power is applied to canister 2 after December 2 2004. However the temperature gradient over the buffer is similar before and after the switch on/off the power of the canisters. The determination of the gradient was made up to the beginning of December 2005. After that the number of still working sensors are too few, to be able to determine the temperature gradient.

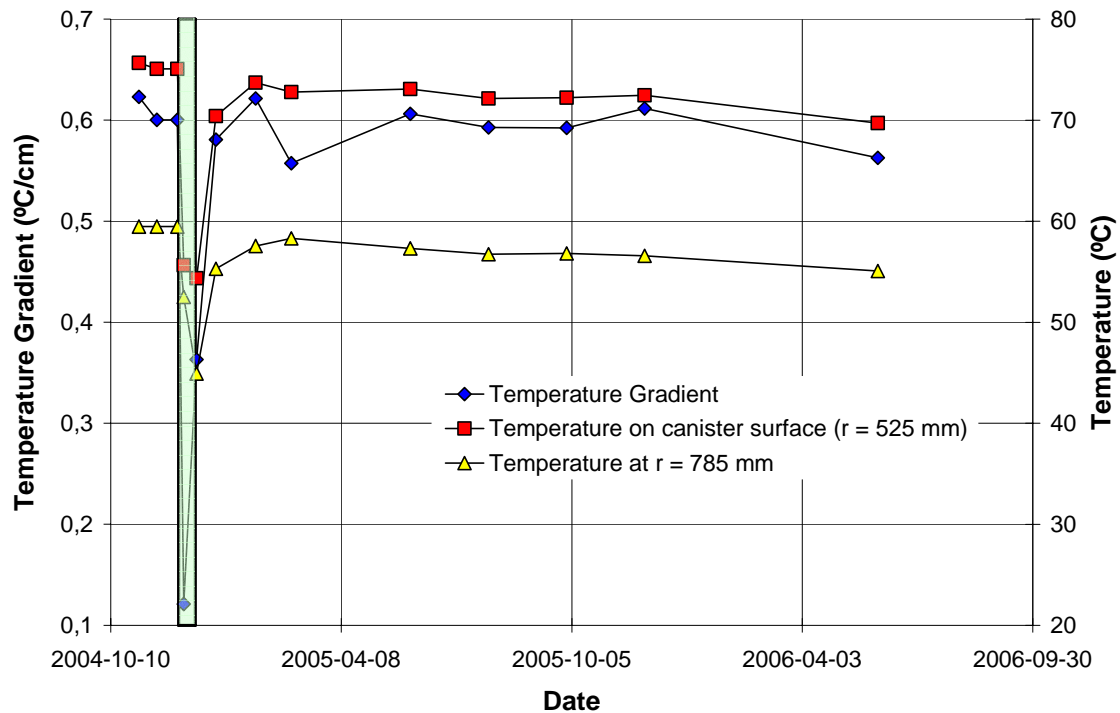


**Figure 5-1.** The temperature in block R5 in Dh 1 as function of radius from the center of the deposition hole on November 15, 2004.



**Figure 5-2.** The temperature in block R5 in Dh 1 as function of radius from the center of the deposition hole on December 6, 2004.





**Figure 5-3.** The temperature and temperature gradient plotted as function the date in deposition hole 1 block R5.

### 5.8.2 Deposition hole 3

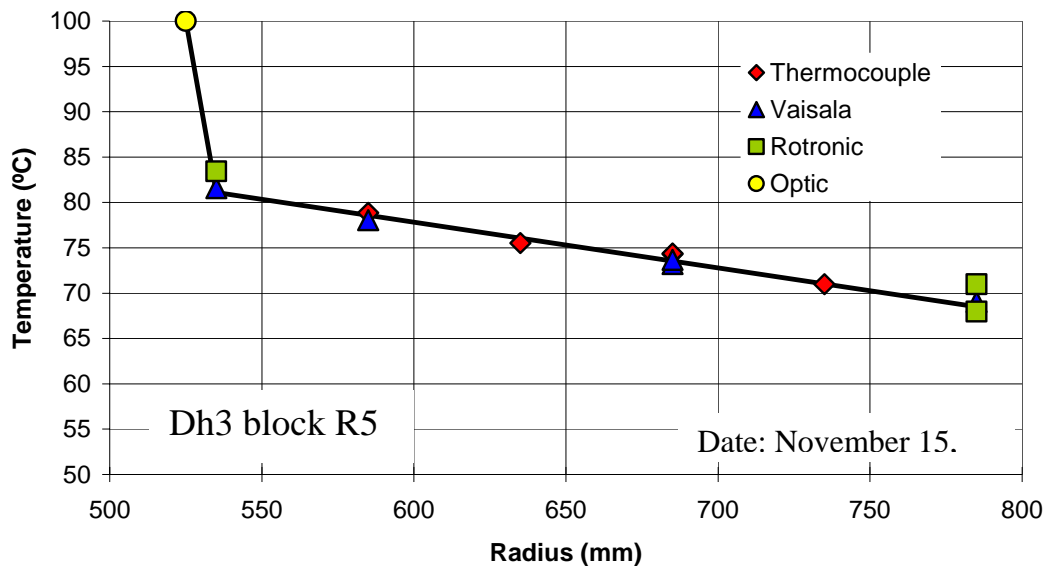
The saturation of the buffer, as an average, indicated by both RH-transducers and total pressure transducers was before the closing of the drainage much lower compared to the buffer in deposition hole 1, although some total pressure transducers placed above and under the canister indicated rather high total pressures. When the drainage was closed those total pressure transducers which before had indicated high total pressure reacted with a rapid increase in pressure while the rest of the transducers did not react at all. When the drainage was opened again and the power to the canisters was switched off there was a decrease in the pressure. For most of the transducers the pressure went down to the same level as before the closing of the drainage. One RH sensor placed in block R5 at a radius of 785 mm reacted with a significant increase in RH (from 70% to 82%) when the drainage was closed. The RH was maintained on the higher level even after the opening of the drainage. Also some transducers placed in the buffer but close the canister top reacted with an increase in RH of about 5%. These transducers had before the closing of the drainage indicated a drying of the buffer. The rest of the RH transducers reacted very little at the closing/opening of the drainage. The buffer is today far from saturated (indicated both with RH-sensors and total pressure sensors).

In Figure 5-4 the temperature in deposition hole 3 is plotted as function of the radial distance from the center of the deposition hole. Compared the corresponding plot for deposition hole 1 this plot shows a significant drop in temperature between the surface of the canister and the buffer (inner diameter of the ring). This indicates that the initial slot (of about 10 mm) between the canister and the buffer was still open.

The temperature gradient over the inner slot together with the temperature on the canister and the temperature on the inner radius of the ring shaped block are plotted as function of time in Figure 5-5. The shaded part of the plot represents the time when the power to canisters was switched off. Immediately after the power was switched off the temperature gradient increased which indicate that the slot was isolating the canister resulting in a much faster drop in temperature of the buffer than the canister surface. When the power was switched on again the temperature gradient over the slot reached the same level as before the closing of the drainage indicating an open slot between the canister and the buffer, but the figure is also show that the gradient is decreasing with time which might be an indication of that the gap is getting smaller. The sensors for measuring the temperature on the canister surface stopped functioning of August 2005. The temperature gradient over the inner slot could not be calculated after that date.

The temperature gradient over the buffer is plotted in Figure 5-6 together with the temperature on the inner surface of the block and the temperature at the radius of  $r = 785$  mm. After the power was switched on again also this gradient stabilized on the same level as before the power was switched off.

A conclusion of the analyses is that even though the pressure in the backfill and in the surrounding rock was high (more than 2 MPa) when the drainage was closed, water did not enter the inner slot between the buffer and the canister. The fact that no water pressure acted directly on the canister surface can also explain the large vertical displacement of the canister measured when the drainage was closed (see Figure 5-7). If the increased pore pressure (2.5 MPa) would act directly on the canister surface the deformation should be much smaller than what was measured. The measured deformation was probably caused by large deformations of the solid bentonite blocks on top and bottom of the canister.



**Figure 5-4.** The temperature in block R5 in Dh 3 as function of radius from the center of the deposition hole on November 15, 2004.

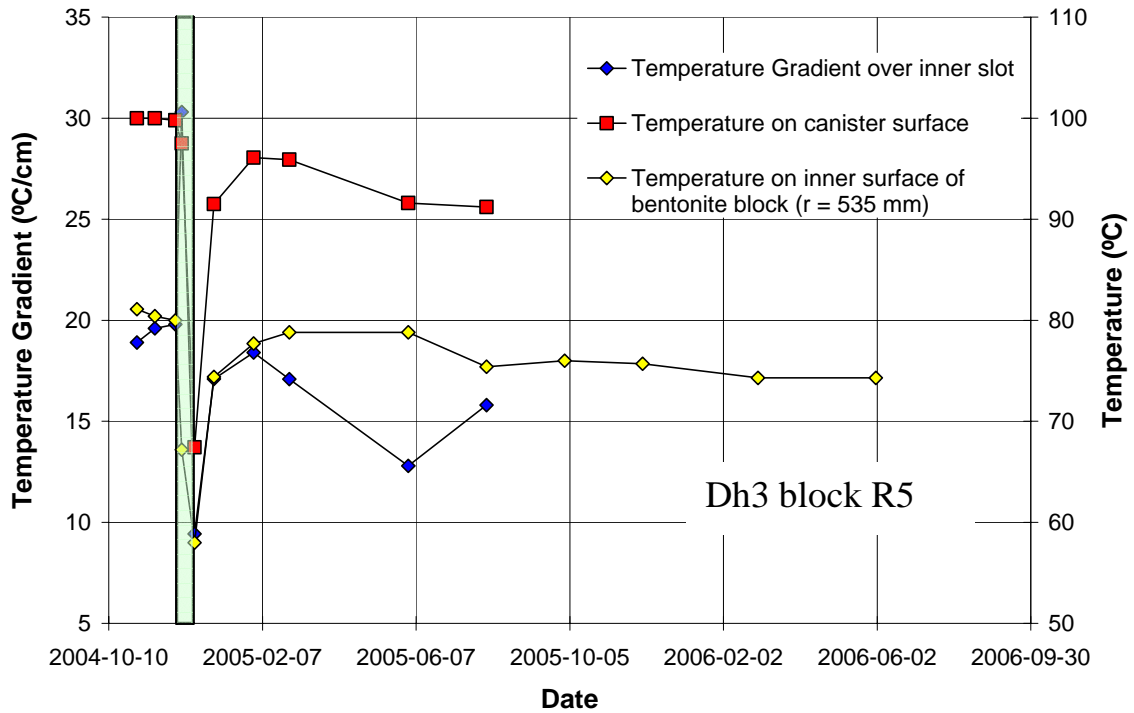


Figure 5-5. The temperature and temperature gradient over the inner slot plotted as function the date in deposition hole 3 block R5.

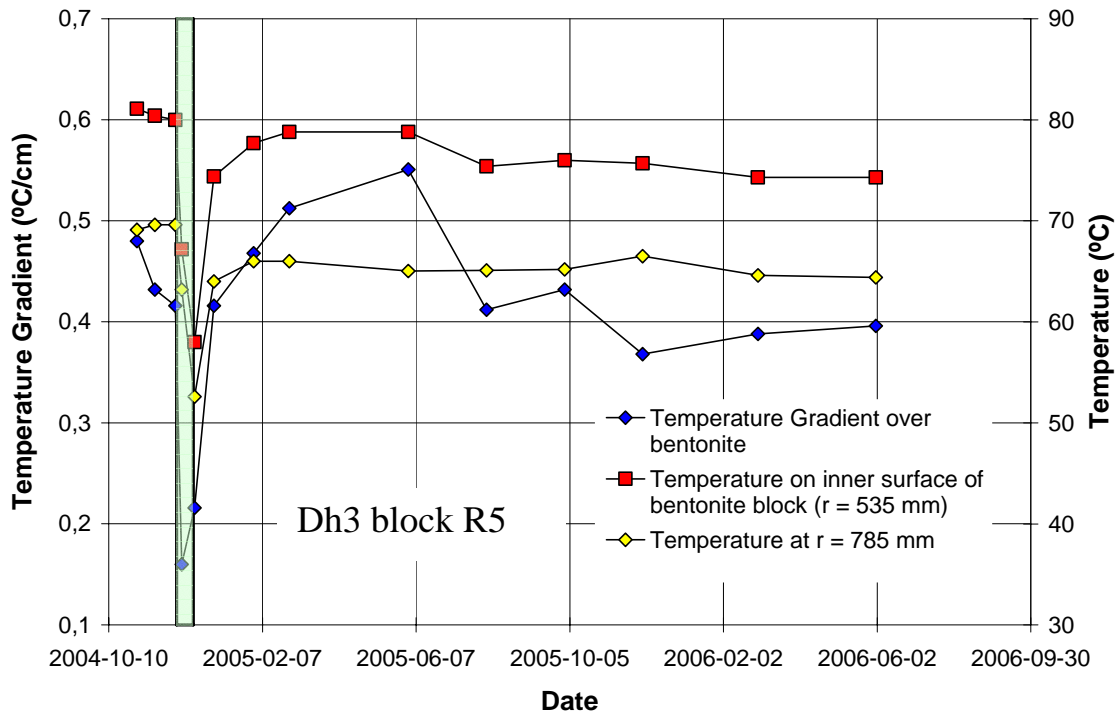
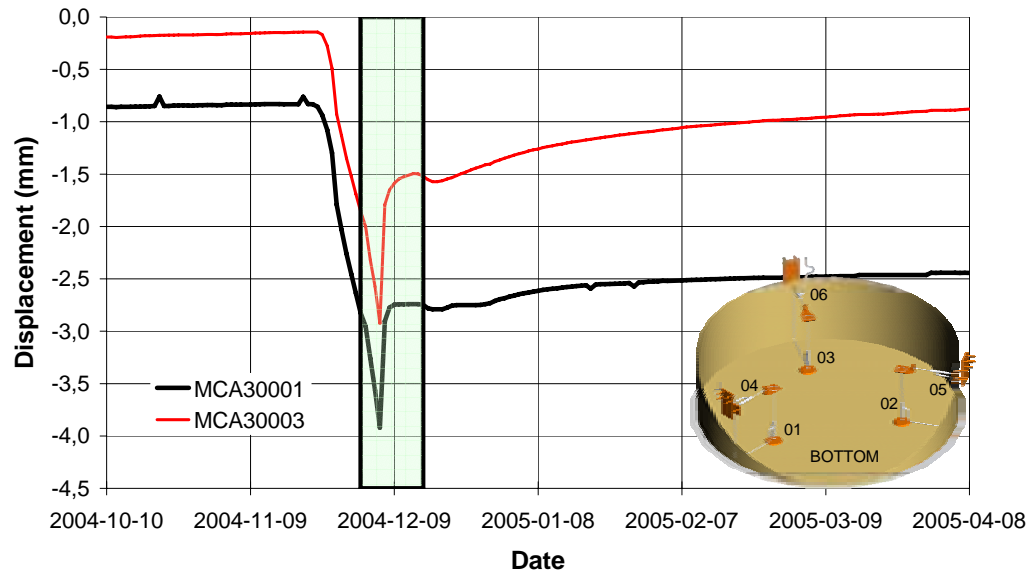


Figure 5-6. The temperature and temperature gradient over the buffer plotted as function the date in deposition hole 3 block R5.



**Figure 5-7.** Vertical displacement of the canister in Dh 3. Negative sign on the displacement means that the canister is moving downwards.

### 5.8.3 Backfill

The pore pressure in the backfill increased fast from a low level when the drainage of the tunnel was closed. This affected the rate in which the backfill was saturated measured both with soil psychrometers and with resistivity measurements made by GRS. After the drainage was reopened the pore pressure stabilized on the same level as before it was close. The saturation rate (measured with both psychrometers and resistivity measurements) decreased to the same rate as before the closing of the drainage for most of the sensors.

When a packer placed in a borehole in Section I was broken (at the middle of April 2006) the pressure in the backfill (both total pressure and pore pressure) increased with about 300 kPa. The increase in pressure affected also the measured suction values (measured with soil psychrometers). Six of the sensors measured a decrease in suction of about 500 kPa due to the broken packer.

## **6 Location of instruments in Section 2**

### **6.1 Strategy for describing the position of each device in the bentonite and rock in and around the deposition holes**

The deposition holes in Section 2 are termed DA3551G01 and DA3545G01, hole number 5 and 6 respectively according to Figure 1-1.

Deposition hole 5 has been instrumented in the same way as the two inner deposition holes, 1 and 3 i.e. measurements have been done in four vertical sections A, B, C and D according to Figure 4-1. (See chapter 4-1)

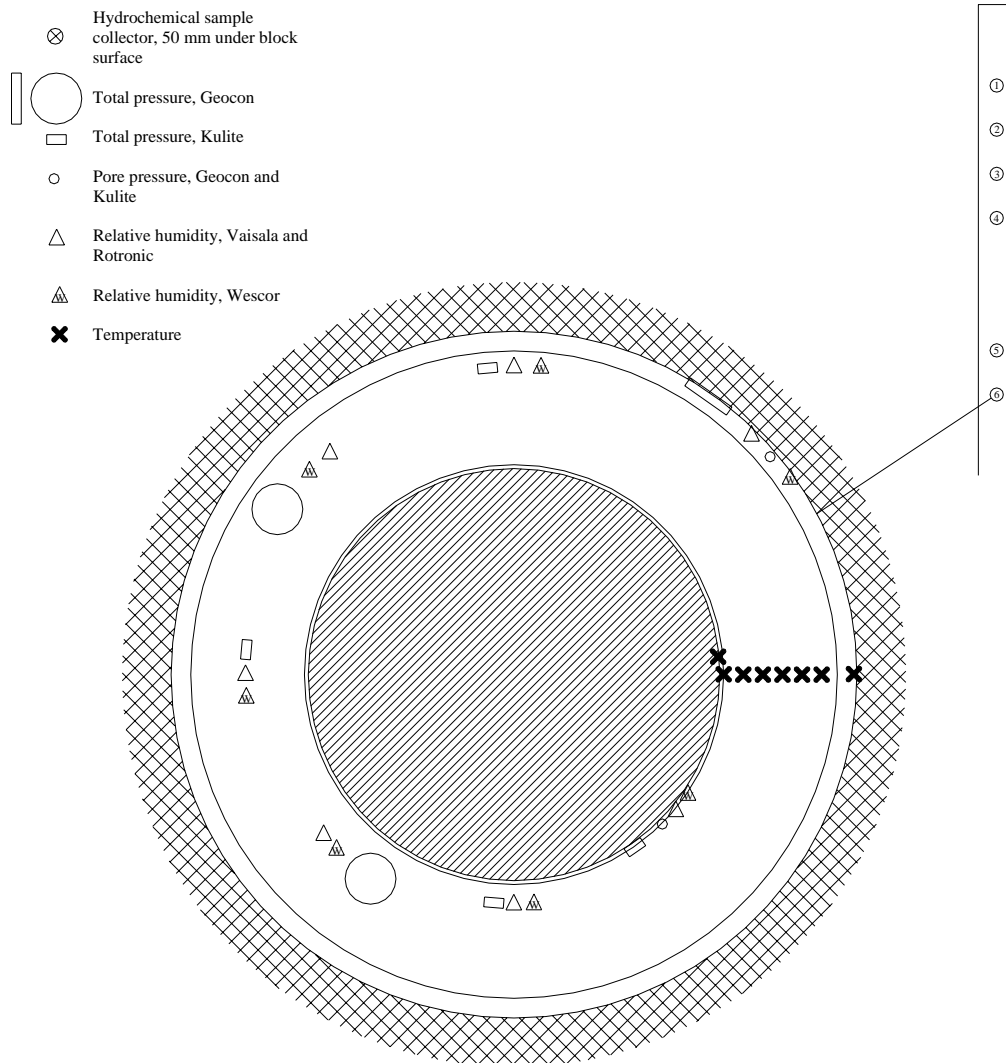
Deposition hole 6 has, however, been instrumented according to another strategy. The instruments have been placed in eight directions, where four directions are represented in each instrumented block, see Figure 6-1.

Direction A and C are placed in the tunnels axial direction with A headed against the end of the tunnel i.e. almost to the West, see Figure 2-1.

Every instrument placed in the buffer is named with a unique name consisting of 1 letter describing the type of measurement, 1 letter describing where the measurement takes place (buffer, rock), 1 figure denoting the deposition hole (5-6) and 2 figures specifying the instrument according to separate lists (see Table 6-1 to 6-11). Every instrument position is then described with three coordinates according to Figure 2-1.

The bentonite blocks are called cylinders and rings. The cylinders are numbered C1-C4 and the rings R1-R10 respectively, see Figure 4-1.

Thermocouples in the rock are placed on 3 levels in each deposition hole (bottom, 3 m and 6 m level). Thermocouples are placed in the bottom of the deposition holes in a vertical hole at the center of the deposition hole. On level 3 m and 6 m the thermocouples are placed in two vertical directions perpendicular to each other.



**Figure 6-1** Schematic view over the instruments positions in deposition hole 6. The instruments are placed in eight vertical sections, where four sections are represented in each instrumented block.

## 6.2 Position of each instrument in the bentonite in hole 5 (DA3551G01)

The instruments are located according to the same system as those in hole 1 and hole 3.

The positions of each instrument are described in Tables 6-1 to 6-4. These tables have been updated since the last data report (Sensors data report No 7).

The positions of 10 Wescor psychrometer sensors were determined after inflow measurement on the wall of the deposition hole. The position of these sensors are described in Table 6-5

**Table 6-1 Numbering and position of instruments for measuring temperature (T) in the buffer in hole 5.**

Typ and number	Block	Instrument position in block				Fabricate	Remark
		Direction	$\alpha$ degree	r m	Z m		
TB501	Cyl. 1	Center	270	0,050	0,080	Pentronic	
TB502	Cyl. 1	Center	270	0,060	0,250	Pentronic	
TB503	Cyl. 1	Center	270	0,070	0,450	Pentronic	
TB504	Cyl. 1	A	355	0,525	0,450	Pentronic	On canister
TB505	Cyl. 1	A	355	0,685	0,450	Pentronic	
TB506	Cyl. 1	B	85	0,685	0,450	Pentronic	
TB507	Cyl. 1	C	175	0,685	0,450	Pentronic	
TB508	Cyl. 1	D	270	0,585	0,450	Pentronic	
TB509	Cyl. 1	D	270	0,685	0,450	Pentronic	
TB510	Cyl. 1	D	270	0,785	0,450	Pentronic	
TB511	Ring 5	A	0	0,525	2,950	Pentronic	On canister
TB512	Ring 5	A	0	0,685	2,986	Pentronic	
TB513	Ring 5	B	85	0,585	2,986	Pentronic	
TB514	Ring 5	B	85	0,685	2,986	Pentronic	
TB515	Ring 5	B	85	0,785	2,986	Pentronic	
TB516	Ring 5	C	175	0,585	2,986	Pentronic	
TB517	Ring 5	C	175	0,685	2,986	Pentronic	
TB518	Ring 5	C	175	0,735	2,986	Pentronic	
TB519	Ring 5	D	270	0,585	2,986	Pentronic	
TB520	Ring 5	D	270	0,635	2,986	Pentronic	
TB521	Ring 5	D	270	0,685	2,986	Pentronic	
TB522	Ring 5	D	270	0,735	2,986	Pentronic	
TB523	Ring 5	D	270	0,785	2,986	Pentronic	
TB524	Ring 10	A	0	0,525	5,150	Pentronic	On canister
TB525	Ring 10	A	0	0,685	5,543	Pentronic	
TB526	Ring 10	D	270	0,585	5,543	Pentronic	
TB527	Ring 10	D	270	0,685	5,543	Pentronic	
TB528	Ring 10	D	270	0,785	5,543	Pentronic	
TB529	Cyl. 3	A	0	0,785	6,353	Pentronic	
TB530	Cyl. 3	B	95	0,585	6,353	Pentronic	
TB531	Cyl. 3	C	185	0,585	6,353	Pentronic	
TB532	Cyl. 4	A	0	0,785	7,060	Pentronic	

**Table 6-2 Numbering and position of instruments for measuring total pressure (P) in the buffer in hole 5.**

Typ and number	Block	Instrument position in block				Fabricate	Remark
		Direction	$\alpha$ degree	r m	Z m		
PB501	Cyl. 1	Center	0	0,000	0,000	Geokon	Bottom
PB502	Cyl. 1	Center	0	0,100	0,500	Geokon	
PB503	Cyl. 1	A	5	0,585	0,340	Kulite	Vertical
PB504	Cyl. 1	A	5	0,685	0,340	Kulite	Vertical
PB505	Cyl. 1	A	5	0,785	0,340	Kulite	Vertical
PB506	Cyl. 1	B	95	0,635	0,500	Geokon	
PB507	Cyl. 1	B	105	0,735	0,500	Geokon	
PB508	Cyl. 1	C	185	0,635	0,500	Geokon	
PB509	Cyl. 1	C	195	0,735	0,500	Geokon	
PB510	Ring 5	A	10	0,535	2,876	Kulite	In the slot
PB511	Ring 5	A	10	0,685	3,036	Geokon	
PB512	Ring 5	A	5	0,825	2,876	Kulite	In the slot
PB513	Ring 5	B	95	0,635	3,036	Geokon	
PB514	Ring 5	B	105	0,785	3,036	Geokon	
PB515	Ring 5	C	190	0,635	3,036	Geokon	
PB516	Ring 5	C	190	0,825	2,876	Kulite	In the slot
PB517	Ring 10	Center	0	0,050	5,593	Geokon	
PB518	Ring 10	A	10	0,585	5,433	Kulite	Vertical
PB519	Ring 10	A	10	0,685	5,433	Kulite	Vertical
PB520	Ring 10	A	10	0,785	5,433	Kulite	Vertical
PB521	Ring 10	B	95	0,635	5,593	Geokon	
PB522	Ring 10	B	105	0,735	5,593	Geokon	
PB523	Ring 10	C	180	0,635	5,593	Geokon	
PB524	Ring 10	C	190	0,735	5,593	Geokon	
PB525	Cyl. 3	Center	0	0,100	6,603	Geokon	
PB526	Cyl. 3	A	5	0,585	6,603	Geokon	
PB527	Cyl. 4	Center	0	0,100	7,110	Geokon	



**Table 6-3** Numbering and position of instruments for measuring pore water pressure (U) in the buffer in hole 5.

Typ and number	Block	Instrument position in block				Fabricate	Remark
		Direction	$\alpha$ degree	r m	Z m		
UB501	Cyl. 1	Center	90	0,050	0,250	Kulite	
UB502	Cyl. 1	Center	90	0,100	0,050	Geokon	
UB503	Cyl. 1	A	355	0,585	0,250	Geokon	
UB504	Cyl. 1	A	355	0,785	0,340	Kulite	
UB505	Ring 5	A	355	0,585	2,786	Geokon	
UB506	Ring 5	A	355	0,785	2,876	Kulite	
UB507	Ring 5	B	85	0,535	2,876	Kulite	In the slot
UB508	Ring 5	B					Not installed
UB509	Ring 5	C	175	0,535	2,786	Geokon	In the slot
UB510	Ring 5	C	175	0,825	2,786	Geokon	In the slot
UB511	Ring 10	A	355	0,585	5,433	Kulite	
UB512	Ring 10	A	355	0,785	5,433	Kulite	
UB513	Cyl. 3	Center					Not installed
UB514	Cyl. 4	Center	90	0,100	6,860	Geokon	

**Table 6-4 Numbering and position of instruments for measuring water content (W) in the buffer in hole 5.**

Mark	Block	Instrument position in block			Fabricate	Remark
		Direction	$\alpha$ degree	r m		
WB501	Cyl. 1	Center	180	0,050	0,250	Rotronic
WB502	Cyl. 1	Center	180	0,100	0,050	Rotronic
WB503	Cyl. 1	Center	0	0,400	0,250	Rotronic
WB504	Cyl. 1	A	350	0,585	0,340	Vaisala
WB505	Cyl. 1	A	350	0,685	0,340	Vaisala
WB506	Cyl. 1	A	350	0,785	0,340	Vaisala
WB507	Cyl. 1	B	80	0,585	0,340	Vaisala
WB508	Cyl. 1	B	80	0,685	0,250	Rotronic
WB509	Cyl. 1	B	80	0,785	0,250	Rotronic
WB510	Cyl. 1	C	170	0,585	0,250	Rotronic
WB511	Cyl. 1	C	170	0,685	0,250	Rotronic
WB512	Cyl. 1	C	170	0,785	0,250	Rotronic
WB513	Ring 5	A	350	0,585	2,876	Vaisala
WB514	Ring 5	A	350	0,685	2,876	Vaisala
WB515	Ring 5	A	350	0,785	2,876	Vaisala
WB516	Ring 5	B	80	0,535	2,786	Rotronic In the slot
WB517	Ring 5	B	80	0,685	2,786	Rotronic
WB518	Ring 5	B	80	0,785	2,786	Rotronic
WB519	Ring 5	C	180	0,535	2,876	Vaisala In the slot
WB520	Ring 5	C	180	0,685	2,876	Vaisala
WB521	Ring 5	C	180	0,785	2,786	Rotronic
WB522	Ring 10	Center	180	0,050	5,433	Vaisala
WB523	Ring 10	A	0	0,262	5,433	Vaisala
WB524	Ring 10	A	350	0,585	5,433	Vaisala
WB525	Ring 10	A	350	0,685	5,433	Vaisala
WB526	Ring 10	A	350	0,785	5,433	Vaisala
WB527	Ring 10	B	80	0,585	5,343	Rotronic
WB528	Ring 10	B	80	0,685	5,343	Rotronic
WB529	Ring 10	B	80	0,785	5,343	Rotronic
WB530	Ring 10	C	170	0,585	5,433	Vaisala
WB531	Ring 10	C	170	0,785	5,343	Rotronic
WB532	Cyl. 3	Center	270	0,100	6,353	Vaisala
WB533	Cyl. 3	A	350	0,585	6,353	Vaisala
WB534	Cyl. 3	B	90	0,585	6,353	Vaisala
WB535	Cyl. 3	C	180	0,585	6,353	Rotronic
WB536	Cyl. 4	Center	180	0,100	6,790	Vaisala
WB537	Cyl. 4	Center	270	0,100	6,950	Vaisala

**Table 6-5 Numbering and position of instruments for measuring water content (W) in the buffer in hole 5. The positions were determined after inflow measurements.**

Mark	Block	Instrument position in block			Z	Fabricate	Remark
		Direction	$\alpha$	r			
			degree	m	m		
WB538	Ring 3	C-D	225	0,775	1,624	Wescor	
WB539	Ring 3	C-D	235	0,68	1,624	Wescor	
WB540	Ring 3	C-D	245	0,585	1,624	Wescor	
WB541	Ring 3	C-D	255	0,68	1,624	Wescor	
WB542	Ring 3	C-D	265	0,775	1,624	Wescor	
WB543	Ring 8	C-D	225	0,775	4,173	Wescor	
WB544	Ring 8	C-D	235	0,68	4,173	Wescor	
WB545	Ring 8	C-D	245	0,585	4,173	Wescor	
WB546	Ring 8	C-D	255	0,68	4,173	Wescor	
WB547	Ring 8	C-D	265	0,775	4,173	Wescor	

### **6.3 Position of each instrument in the bentonite in hole 6 (DA3545G01)**

The instruments are located in one main level in the blocks, 250 mm, from the upper surface. The upper blocks, C2, C3 and C4 are instrumented in the same way as those in deposition hole 5. The positions of each instrument are described in Tables 6-6 to 6-9. These tables have been updated since the last data report (Sensors data report No 7).

The position of 10 Wescor psychrometers and 5 Vaisala relative humidity sensors were determined after inflow measurement. The positions of these transducers are described in Table 6-10.

**Table 6-6 Numbering and position of instruments for measuring temperature (T) in the buffer in hole 6.**

Typ and number	Block	Instrument position in block				Fabricate	Remark
		Direction	$\alpha$ degree	r m	Z m		
TB601	Cyl. 1	Center	45	0,050	0,385	Pentronic	
TB602	Cyl. 1	Center	315	0,050	0,260	Pentronic	
TB603	Cyl. 1	Center	0	0,050	0,135	Pentronic	
TB604	Ring 1	D	270	0,535	0,770	Pentronic	
TB605	Ring 1	D	270	0,585	0,770	Pentronic	
TB606	Ring 1	D	270	0,635	0,770	Pentronic	
TB607	Ring 1	D	270	0,685	0,770	Pentronic	
TB608	Ring 1	D	270	0,735	0,770	Pentronic	
TB609	Ring 1	D	270	0,785	0,770	Pentronic	
TB610	Ring 1	D	270	0,825	0,753	Pentronic	On rock
TB611	Ring 1	D	0	0,525	0,753	Pentronic	On canister
TB612	Ring 5	D	270	0,535	2,795	Pentronic	
TB613	Ring 5	D	270	0,585	2,795	Pentronic	
TB614	Ring 5	D	270	0,635	2,795	Pentronic	
TB615	Ring 5	D	270	0,685	2,795	Pentronic	
TB616	Ring 5	D	270	0,735	2,795	Pentronic	
TB617	Ring 5	D	270	0,785	2,795	Pentronic	
TB618	Ring 5	D	270	0,825	2,753	Pentronic	On rock
TB619	Ring 5	D	0	0,525	2,753	Pentronic	On canister
TB620	Ring 8	D	270	0,535	4,324	Pentronic	
TB621	Ring 8	D	270	0,585	4,324	Pentronic	
TB622	Ring 8	D	270	0,635	4,324	Pentronic	
TB623	Ring 8	D	270	0,685	4,324	Pentronic	
TB624	Ring 8	D	270	0,735	4,324	Pentronic	
TB625	Ring 8	D	270	0,785	4,324	Pentronic	
TB626	Ring 8	D	270	0,825	4,253	Pentronic	On rock
TB627	Ring 8	D	0	0,525	4,253	Pentronic	On canister
TB628	Cyl. 3	A	0	0,785	6,366	Pentronic	
TB629	Cyl. 3	B	95	0,585	6,366	Pentronic	
TB630	Cyl. 3	C	185	0,585	6,366	Pentronic	
TB631	Cyl. 4	Center	225	0,100	7,071	Pentronic	
TB632	Cyl. 4	A	0	0,785	7,071	Pentronic	

**Table 6-7 Numbering and position of instruments for measuring total pressure (P) in the buffer in hole 6.**

Typ and number	Block	Instrument position in block				Fabricate	Remark
		Direction	$\alpha$ degree	r m	Z m		
PB601	Cyl. 1	Center	315	0,210	0,510	Geokon	
PB602	Cyl. 1	B	80	0,685	0,260	Kulite	Vertical
PB603	Ring 1	A	10	0,785	0,770	Kulite	Vertical
PB604	Ring 1	B	80	0,685	0,770	Kulite	Vertical
PB605	Ring 1	C	170	0,585	0,770	Kulite	Vertical
PB606	Ring 2	AB	55	0,735	1,534	Geokon	
PB607	Ring 2	BC	145	0,635	1,534	Geokon	
PB608	Ring 2	CD	215	0,535	1,284	Kulite	In the slot
PB609	Ring 2	DA	325	0,875	1,253	Geokon	At rock
PB610	Ring 5	A	10	0,785	2,795	Kulite	Vertical
PB611	Ring 5	B	80	0,685	2,795	Kulite	Vertical
PB612	Ring 5	C	170	0,585	2,795	Kulite	Vertical
PB613	Ring 6	AB	55	0,785	3,550	Geokon	
PB614	Ring 6	BC	145	0,635	3,550	Geokon	
PB615	Ring 6	CD	215	0,535	3,300	Kulite	In the slot
PB616	Ring 6	DA	325	0,875	3,253	Geokon	At rock
PB617	Ring 8	A	10	0,785	4,324	Kulite	Vertical
PB618	Ring 8	B	80	0,685	4,324	Kulite	Vertical
PB619	Ring 8	C	170	0,585	4,324	Kulite	Vertical
PB620	Ring 9	AB	55	0,735	5,084	Geokon	
PB621	Ring 9	BC	145	0,635	5,084	Geokon	
PB622	Ring 9	CD	215	0,535	4,834	Kulite	In the slot
PB623	Ring 9	DA	325	0,875	4,753	Geokon	At rock
PB624	Cyl. 4	Center	135	0,585	7,121	Kulite	
PB625	Cyl. 3	Center	0	0,100	6,616	Geokon	
PB626	Cyl. 3	A	5	0,585	6,616	Geokon	
PB627	Cyl. 4	Center	0	0,100	7,121	Geokon	

**Table 6-8 Numbering and position of instruments for measuring pore water pressure (U) in the buffer in hole 6.**

Typ and number	Block	Instrument position in block				Fabricate	Remark
		Direction	$\alpha$	r	Z		
			degree	m	m		
UB601	Cyl. 1	Center	280	0,210	0,260	Kulite	
UB602	Cyl. 1	B	95	0,685	0,260	Geokon	
UB603	Ring 2	CD	225	0,535	1,284	Geokon	In the slot
UB604	Ring 2	DA	310	0,875	1,253	Kulite	At the rock
UB605	Ring 5	C	190	0,585	2,795	Geokon	
UB606	Ring 5	A	350	0,785	2,795	Kulite	
UB607	Ring 6	AB	35	0,735	3,300	Kulite	
UB608	Ring 6	BC	125	0,635	3,300	Kulite	
UB609	Ring 6	CD	225	0,535	3,300	Geokon	In the slot
UB610	Ring 6	DA	310	0,875	3,253	Geokon	At the rock
UB611	Ring 9	CD	225	0,535	4,834	Geokon	In the slot
UB612	Ring 9	DA	310	0,875	4,753	Kulite	At the rock
UB613	Cyl. 3	Center	135	0,100	6,366	Kulite	
UB614	Cyl. 4	Center	90	0,100	6,961	Kulite	

**Table 6-9 Numbering and position of instruments for measuring water content (W) in the buffer in hole 6.**

Typ and number	Block	Instrument position in block				Fabricate	Remark
		Direction	$\alpha$ degree	r m	Z m		
WB601	Cyl. 1	Center	135	0,050	0,260	Rotronic	
WB602	Cyl. 1	Center	225	0,050	0,260	Wescor	
WB603	Cyl. 1	Center	260	0,210	0,260	Wescor	
WB604	Cyl. 1	Center	270	0,210	0,260	Rotronic	
WB605	Cyl. 1	B	90	0,685	0,260	Wescor	
WB606	Cyl. 1	B	100	0,685	0,260	Rotronic	
WB607	Ring 1	B	90	0,685	0,770	Vaisala	
WB608	Ring 1	B	95	0,685	0,770	Wescor	
WB609	Ring 1	C	180	0,585	0,770	Vaisala	
WB610	Ring 1	C	185	0,585	0,770	Wescor	
WB611	Ring 1	A	355	0,785	0,770	Wescor	
WB612	Ring 1	A	360	0,785	0,770	Vaisala	
WB613	Ring 2	AB	40	0,735	1,284	Rotronic	
WB614	Ring 2	AB	45	0,735	1,284	Wescor	
WB615	Ring 2	BC	130	0,635	1,284	Rotronic	
WB616	Ring 2	BC	135	0,635	1,284	Wescor	
WB617	Ring 2	CD	230	0,535	1,284	Rotronic	In the slot
WB618	Ring 2	CD	235	0,535	1,284	Wescor	In the slot
WB619	Ring 2	DA	305	0,875	1,253	Wescor	At rock
WB620	Ring 2	DA	315	0,875	1,253	Rotronic	At rock
WB621	Ring 5	B	90	0,685	2,795	Rotronic	
WB622	Ring 5	B	95	0,685	2,795	Wescor	
WB623	Ring 5	C	180	0,585	2,795	Rotronic	
WB624	Ring 5	C	185	0,585	2,795	Wescor	
WB625	Ring 5	A	355	0,785	2,795	Wescor	
WB626	Ring 5	A	360	0,785	2,795	Rotronic	
WB627	Ring 6	AB	40	0,735	3,300	Vaisala	
WB628	Ring 6	AB	45	0,735	3,300	Wescor	
WB629	Ring 6	BC	130	0,635	3,300	Vaisala	
WB630	Ring 6	BC	135	0,635	3,300	Wescor	
WB631	Ring 6	CD	230	0,535	3,300	Vaisala	In the slot
WB632	Ring 6	CD	235	0,535	3,300	Wescor	In the slot
WB633	Ring 6	DA	305	0,875	3,253	Wescor	At rock
WB634	Ring 6	DA	315	0,875	3,253	Vaisala	At rock
WB635	Ring 8	B	90	0,685	4,324	Rotronic	
WB636	Ring 8	B	95	0,685	4,324	Wescor	
WB637	Ring 8	C	180	0,585	4,324	Rotronic	
WB638	Ring 8	C	185	0,585	4,324	Wescor	
WB639	Ring 8	A	355	0,785	4,324	Wescor	
WB640	Ring 8	A	360	0,785	4,324	Rotronic	
WB641	Ring 9	AB	40	0,735	4,834	Rotronic	
WB642	Ring 9	AB	45	0,735	4,834	Wescor	
WB643	Ring 9	BC	130	0,635	4,834	Vaisala	
WB644	Ring 9	BC	135	0,635	4,834	Wescor	
WB645	Ring 9	CD	230	0,535	4,834	Vaisala	In the slot
WB646	Ring 9	CD	235	0,535	4,834	Wescor	In the slot
WB647	Ring 9	DA	305	0,875	4,753	Wescor	At rock
WB648	Ring 9	DA	315	0,875	4,753	Vaisala	At rock
WB649	Ring 10	Center	90	0,050	5,439	Vaisala	
WB650	Ring 10	Center	270	0,210	5,439	Vaisala	
WB651	Cyl. 3	Center	225	0,100	6,366	Rotronic	
WB652	Cyl. 3	B	90	0,585	6,366	Vaisala	
WB653	Cyl. 3	C	180	0,585	6,366	Rotronic	
WB654	Cyl. 3	A	350	0,585	6,366	Vaisala	
WB655	Cyl. 4	Center	180	0,100	6,801	Rotronic	
WB656	Cyl. 4	Center	270	0,100	6,961	Vaisala	

**Table 6-10 Numbering and position of instruments for measuring water content (W) in the buffer in hole 6. The positions were determined after inflow measurements.**

Typ and number	Block	Instrument position in block					Remark
		Direction	$\alpha$ degree	r m	Z m	Fabricate	
WB657	Ring 6	C	190	0,625	3,300	Wescor	
WB658	Ring 6	C	190	0,725	3,300	Wescor	
WB659	Rock	C	190	0,900	3,100	Wescor	
WB660	Rock	C	190	0,925	3,250	Wescor	
WB661	Rock	C	190	0,975	3,400	Wescor	
WB662	Ring 8	D	280	0,625	4,324	Wescor	
WB663	Ring 8	D	280	0,725	4,324	Wescor	
WB664	Rock	D	280	0,900	4,100	Wescor	
WB665	Rock	D	280	0,925	4,250	Wescor	
WB666	Rock	D	280	0,975	4,400	Wescor	
WB667	Cyl.1	D	280	0,685	0,260	Vaisala	
WB668	Ring 6	C	200	0,625	3,300	Vaisala	
WB669	Ring 6	C	200	0,725	3,300	Vaisala	
WB670	Ring 8	D	290	0,625	4,324	Vaisala	
WB671	Ring 8	D	290	0,725	4,324	Vaisala	

## 6.4 Instruments on the canister surface in holes 5-6

A system for measuring the temperature with optical cables on the surface of the canisters is used in the same way as for the canisters in Section 1. The system is described in chapter 4.4.

In addition to the optical cables three thermocouples (TB504, TB511 and TB524) in deposition hole 5 and three thermocouples (TB611, TB619 and TB627) in deposition hole 6 are fixed to the surface of the canister (see Table 6-1 and 6-6).

## 6.5 Position of temperature sensors in the rock

Thermocouples are placed on 3 levels in each deposition hole (bottom, 3 m and 6 m level). On level 3 m and 6 m the thermocouples are placed in two directions perpendicular to each other.

The positions are described in Table 6-11.



Table 6-11. Numbering and position of temperature sensors in the rock.

Type and number	Depth from rock surface(m)	$\alpha$ degree	r m	Z m	Remark
<b>Measured from DA3551G01(Hole 5)</b>					
TR5011	1,000	0°	0,000	-1,000	Bottom
TR5012	0,500	0°	0,000	-0,500	Bottom
TR5013	0,200	0°	0,000	-0,200	Bottom
TR5014	0,000	0°	0,000	0,000	Bottom
TR5021	2,200	180°	3,950	6,000	East
TR5022	1,100	180°	2,850	6,000	East
TR5023	0,600	180°	2,350	6,000	East
TR5024	0,200	180°	1,950	6,000	East
TR5025	0,000	180°	1,750	6,000	East
TR5031	2,200	90°	3,950	6,000	South
TR5032	1,100	90°	2,850	6,000	South
TR5033	0,600	90°	2,350	6,000	South
TR5034	0,200	90°	1,950	6,000	South
TR5035	0,000	90°	1,750	6,000	South
TR5041	2,200	180°	3,950	3,000	East
TR5042	1,100	180°	2,850	3,000	East
TR5043	0,600	180°	2,350	3,000	East
TR5044	0,200	180°	1,950	3,000	East
TR5045	0,000	180°	1,750	3,000	East
TR5051	2,200	90°	3,950	3,000	South
TR5052	1,100	90°	2,850	3,000	South
TR5053	0,600	90°	2,350	3,000	South
TR5054	0,200	90°	1,950	3,000	South
TR5055	0,000	90°	1,750	3,000	South
<b>Measured from DA3545G01(Hole 6)</b>					
TR6011	1,000	0	0,000	-1,000	Bottom
TR6012	0,500	0	0,000	-0,500	Bottom
TR6013	0,200	0	0,000	-0,200	Bottom
TR6014	0,000	0	0,000	0,000	Bottom
TR6021	2,200	90°	3,950	6,000	South
TR6022	1,100	90°	2,850	6,000	South
TR6023	0,600	90°	2,350	6,000	South
TR6024	0,200	90°	1,950	6,000	South
TR6025	0,000	90°	1,750	6,000	South
TR6031	2,200	360°	3,950	6,000	West
TR6032	1,100	360°	2,850	6,000	West
TR6033	0,600	360°	2,350	6,000	West
TR6034	0,200	360°	1,950	6,000	West
TR6035	0,000	360°	1,750	6,000	West
TR6041	2,200	90°	3,950	3,000	South
TR6042	1,100	90°	2,850	3,000	South
TR6043	0,600	90°	2,350	3,000	South
TR6044	0,200	90°	1,950	3,000	South
TR6045	0,000	90°	1,750	3,000	South
TR6051	2,200	360°	3,950	3,000	West
TR6052	1,100	360°	2,850	3,000	West
TR6053	0,600	360°	2,350	3,000	West
TR6054	0,200	360°	1,950	3,000	West
TR6055	0,000	360°	1,750	3,000	West

## 6.6 Strategy for describing the position of each device in the backfill in section 2

The strategy for instrumentation of the backfill in Section 2 is the same as in Section 1 and is described in chapter 4.6.

## 6.7 Position of each instrument in the backfill in Section 2

The positions of each instrument are described in Tables 6-12 to 6-15.

**Table 6-12** Numbering and position of instruments for measuring temperature (T) in the backfill in section 2.

Type and number	Instrument position			Fabricate	Remark
	Section	x	z		
		m	m	m	
TFA01	E, over dep.hole 5	0,0	2,3	3551,0	Pentronic
TFA02	E, over dep.hole 5	0,0	1,25	3551,0	Pentronic
TFA03	E, over dep.hole 5	0,0	-0,8	3551,0	Pentronic
TFA04	E, over dep.hole 5	-0,5	-2,6	3551,0	Pentronic
TFA05	E, over dep.hole 5	0,5	-2,6	3551,0	Pentronic
TFA06	E, over dep.hole 5	-1,25	0,0	3551,0	Pentronic
TFA07	E, over dep.hole 5	1,25	0,0	3551,0	Pentronic
TFA08	F, between dep.hole 5 and 6	0,0	1,0	3548,0	Pentronic
TFA09	F, between dep.hole 5 and 6	0,0	-1,25	3548,0	Pentronic
TFA10	E, over dep.hole 6	0,0	2,3	3545,0	Pentronic
TFA11	E, over dep.hole 6	0,0	1,25	3545,0	Pentronic
TFA12	E, over dep.hole 6	0,0	-0,8	3545,0	Pentronic
TFA13	E, over dep.hole 6	-0,5	-2,6	3545,0	Pentronic
TFA14	E, over dep.hole 6	0,5	-2,6	3545,0	Pentronic
TFA15	E, over dep.hole 6	-1,25	0,0	3545,0	Pentronic
TFA16	E, over dep.hole 6	1,25	0,0	3545,0	Pentronic

**Table 6-13 Numbering and position of instruments for measuring total pressure (P) in the backfill in section 2.**

Type and number	Instrument position			Fabricate	Remark
	Section	x	z		
		m	m	m	
PFA01	Inner part	0,0	0,0	3555,8	Kulite
PFA02	E, over dep.hole 5	0,0	0,0	3551,0	Geokon
PFA03	E, over dep.hole 5	0,0	-1,75	3551,0	Geokon
PFA04	E, over dep.hole 5	0,0	-2,6	3551,0	Geokon
PFA05	E, over dep.hole 5	0,0	-3,15	3551,0	Kulite
PFA06	E, over dep.hole 5	-2,3	0,0	3551,0	Kulite
PFA07	E, over dep.hole 5	0,0	2,3	3551,0	Kulite
PFA08	F, between dep.hole 5 and 6	0,0	0,0	3548,0	Geokon
PFA09	F, between dep.hole 5 and 6	0,0	-2	3548,0	Geokon
PFA10	E, over dep.hole 6	0,0	0,0	3545,0	Kulite
PFA11	E, over dep.hole 6	0,0	-1,75	3545,0	Kulite
PFA12	E, over dep.hole 6	0,0	-2,6	3545,0	Kulite
PFA13	E, over dep.hole 6	0,0	-3,15	3545,0	Geokon
PFA14	E, over dep.hole 6	-2,3	0,0	3545,0	Geokon
PFA15	E, over dep.hole 6	0,0	2,3	3545,0	Geokon
PFA16	In front of plug	0,0	0,0	3539,0	Kulite

**Table 6-14 Numbering and position of instruments for measuring pore water pressure (U) in the backfill in section 2.**

Type and number	Instrument position			Fabricate	Remark
	Section	x	z		
		m	m	m	
UFA01	Inner part	0,0	0,0	3555,8	Kulite
UFA02	Inner part	0,0	0,0	3554,1	Geokon
UFA03	E, over dep.hole 5	0,0	0,0	3551,0	Geokon
UFA04	E, over dep.hole 5	0,0	-1,75	3551,0	Kulite
UFA05	E, over dep.hole 5	0,0	-2,6	3551,1	Kulite
UFA06	E, over dep.hole 5	0,0	-3,15	3551,0	Kulite
UFA07	E, over dep.hole 5	0,0	-1,75	3551,0	Geokon
UFA08	E, over dep.hole 5	0,0	2,3	3551,0	Geokon
UFA09	F, between dep.hole 5 and 6	0,0	0,0	3548,0	Geokon
UFA10	F, between dep.hole 5 and 6	0,0	-2,0	3548,0	Geokon
UFA11	E, over dep.hole 6	0,0	0,0	3545,0	Geokon
UFA12	E, over dep.hole 6	0,0	-1,75	3545,0	Geokon
UFA13	E, over dep.hole 6	0,0	-2,6	3545,0	Geokon
UFA14	E, over dep.hole 6	0,0	-3,15	3545,0	Geokon
UFA15	E, over dep.hole 6	-2,3	0,0	3545,0	Geokon
UFA16	E, over dep.hole 6	0,0	2,3	3545,0	Geokon
UFA17	In front of plug	-2,3	0,0	3551,0	Geokon
UFA18	In front of plug	0,0	0,0	3539,0	Geokon

**Table 6-15 Numbering and position of instruments for measuring relative humidity (W) in the backfill in section 2.**

Type and number	Instrument position			Fabricate	Remark	
	Section	x	z			y
		m	m	m		
WFA01	Inner part	0,0	0,0	3555,8	Wescor	
WFA02	Inner part	0,0	0,0	3554,1	Wescor	
WFA03	E, over dep.hole 5	0,0	2,3	3551,0	Wescor	
WFA04	E, over dep.hole 5	0,0	1,25	3551,0	Wescor	
WFA05	E, over dep.hole 5	0,0	0,0	3551,0	Wescor	
WFA06	E, over dep.hole 5	0,0	-0,8	3551,0	Wescor	
WFA07	E, over dep.hole 5	2,3	0,0	3545,0	Wescor	
WFA08	E, over dep.hole 5	0,0	-2,6	3550,9	Wescor	
WFA09	E, over dep.hole 5	0,0	-3,15	3551,0	Wescor	
WFA10	E, over dep.hole 5	-2,3	0,0	3551,0	Wescor	
WFA11	E, over dep.hole 5	-1,25	0,0	3551,0	Wescor	
WFA12	E, over dep.hole 5	1,25	0,0	3551,0	Wescor	
WFA13	E, over dep.hole 5	2,3	0,0	3551,0	Wescor	
WFA14	F, between dep.hole 5 and 6				Wescor	Not clear
WFA15	F, between dep.hole 5 and 6	0,0	1,0	3548,0	Wescor	
WFA16	F, between dep.hole 5 and 6	0,0	0,0	3548,0	Wescor	
WFA17	F, between dep.hole 5 and 6	0,0	-0,55	3548,0	Wescor	
WFA18	F, between dep.hole 5 and 6	-1,25	0,0	3548,0	Wescor	
WFA19	F, between dep.hole 5 and 6	1,25	0,0	3548,0	Wescor	
WFA20	E, over dep.hole 6	0,0	2,3	3545,0	Wescor	
WFA21	E, over dep.hole 6	0,0	1,25	3545,0	Wescor	
WFA22	E, over dep.hole 6	0,0	0,0	3545,0	Wescor	
WFA23	E, over dep.hole 6	0,0	-0,8	3545,0	Wescor	
WFA24	E, over dep.hole 6	0,0	-1,75	3545,0	Wescor	
WFA25	E, over dep.hole 6	0,0	-2,6	3545,0	Wescor	
WFA26	E, over dep.hole 6	0,0	-3,15	3545,0	Wescor	
WFA27	E, over dep.hole 6	-2,3	0,0	3545,0	Wescor	
WFA28	E, over dep.hole 6	-1,25	0,0	3545,0	Wescor	
WFA29	E, over dep.hole 6	1,25	0,0	3545,0	Wescor	
WFA30	E, over dep.hole 6	0,0	2,3	3548,0	Wescor	
WFA31	In front of plug	0,0	0,0	3540,0	Wescor	
WFA32	In front of plug	0,0	0,0	3539,0	Wescor	



## 7 Results and comments for Section 2

### 7.1 General

In this chapter short comments on general trends in the measurements are given. Sensors that are not delivering reliable data or no data at all are noted and comments on the data collection in general are given.

The heating of the canister in hole 5 started with an applied constant power of 1800 W at 030508. This date is also marked as start date. The backfilling started 030429 and was finished 030625 and the plug was cast at 030911. Table 7-1 shows some important dates for section 2.

**Table 7-1. Key dates for section 2**

Activity	Date
Start backfilling	29/4 2003
Start heating canister 5	8/5 2003
Start heating canister 6	23/5 2003
Finished backfilling	25/6 2003
Plug casting	11/9 2003
Decreased power (-30 W)	8/9 2004
The power to all canisters was switched off	2/12 2004
The drainage of the tunnel was opened	6/12 2004
The power to the canisters was switched on	15/12 2004
The power to canister 6 was switched off	6/9 2005
The power to canister 6 was switched on	2/11 2005
Decreased power (-30 W)	2/12 2005

86 out of 394 sensors (excluding water pressure sensors in the rock, geo-electric measurements, stress and strain in the rock and displacement of canister) are out of order.

The processes have been slow up to about 20 days after the drainage of the tunnel was closed. Very small changes of the measured parameters have occurred up to that date. After that the readings from some of the total and pore pressure sensors placed in the buffer have reacted strongly (quick increase in pressure). Also the total and pore pressure sensors placed in the backfill have recorded high pressures caused by the closing of the drainage. After the opening of the drainage of the tunnel, both the pore pressures and the total pressures were stabilized on a higher level than before the closing of the drainage.

The maximum measured temperature on the canister in deposition hole 5 is about 84 °C. For the canister in deposition hole 6 the maximum temperature is about 88 °C.

## **7.2 Deposition hole 5**

### **7.2.1 Total pressure**

#### **Geokon (App. 5\pages 181-184)**

The measured pressure range is from 0 to 9 MPa. PB506 placed in block C1 shows a strong increasing of the total pressure since day 200. High pressures are also indicated by sensors in block R5 and R10. PB511 in block R5 showed a very quick increase in pressure from day 520 up to the day when the power was switched off. After that a drop in pressure of 2 MPa was observed and then an increase in pressure to about 9 MPa. The pressure dropped then to about 6 MPa and has during this measuring period been stabilized on that level. Two sensors placed in block R10 (PB521 and PB522) showed a drop in total pressure at around day 300 and then they were stabilized on a pressure of about 2 MPa. These two sensors measured an increase in pressure when the drainage was closed. When the power to the canister was switched off the pressures measured with these sensors decreased quickly with about 2 MPa. After the power was switched on again the measured pressures increased very quickly to the same level as before the power was switched off. The measured pressures are continuing to increase and are at the end of this measuring period about 3.5 MPa.

Four sensors are out of order.

#### **Kulite (App. 5\page 185)**

The highest pressure 1.5 MPa is measured by a peripheral sensor in block R10. Sensor PB519, also placed in block R10 but closer to the canister shows a pressure of 1.0 MPa. A sensor (PB510) placed in the peripheral of block R5 measure a total pressure close to 1.2 MPa. The rest of the sensors measure low pressures.

Two sensors are out of order.

### **7.2.2 Relative humidity/suction in dep. hole 5**

#### **Vaisala (App. 5\pages 186-189)**

Since temperature is also measured with all relative humidity sensors, the diagrams include those measured temperatures. The temperature measurements start at about 16 degrees while the RH measurements start at about 70 % RH.

The sensors placed in the bottom block C1 show very small changes in RH with time. The measured relative humidity varies between 70-85 %.

One sensor placed in block R5 close to the canister (WB519) indicated a very strong drying of the bentonite until day 170 when it stopped to give reliable values. Sensor WB520 placed in the middle of block R5 indicated also an initial drying of the bentonite. The rest of the sensors in block R5 indicate a slowly wetting of the buffer (increase in RH).



Two sensors in block R10 placed close to the top of the canister (WB522, WB523) indicated a drying of the bentonite up to day 350 and after that a slowly wetting. The rest of the sensors in block R10 indicate a wetting of the buffer. The relative humidity at the end of this measuring period varies between 50% close to the canister lid and 85% at the periphery of the bentonite block.

Three sensors placed in block C3 and C4 indicate a slowly wetting of the buffer.

Seven sensors are out of order.

#### **Rotronic (App. 5\pages 190-194)**

Five of the sensors placed in the bottom block C1 show very small changes in RH with the time, while three sensors (WB508, WB509 and WB511) indicate a slowly wetting of the bentonite.

One sensor placed in block R5 close to the canister (WB516) indicated a very strong drying of the bentonite for the first 60 days. The sensor indicated then a wetting for the next 60 days and after that another period of drying until day 230. After that the sensor is measuring an increase in Relative Humidity indicating a wetting of the buffer.

One sensor placed in block C3 indicates a slowly wetting of the bentonite.

Eight sensors are out of order.

#### **Wescor Psychrometers (App.5\page 195)**

The Wescor sensors can measure suction between 6000 and 200 kPa.

Two of totally ten sensors are beginning to measure a decrease in suction of the buffer. These sensors (WB358 and WB542) are placed near the periphery of block R3.

### **7.2.3 Pore water pressure**

#### **Geokon (App. 5\page 196)**

All sensors yield very low pressures.

#### **Kulite (App. 5\page 197)**

Sensors UB508 was out of order from start and it is not plotted in this report.

All the installed sensors yield very low pressure.

Three sensors are out of order.

### **7.2.4 Temperature in the buffer (App. 5\pages 198-209)**

Three thermocouples (TB504, TB511 and TB524) are placed on the surface of the canister. TB504 placed closed to the bottom of the canister shows a maximum temperature of about 70 °C , TB511 placed at the middle of canister about 77 °C and TB524 placed close to the top of the canister shows a maximum temperature of about 70 °C.

High temperatures are measured with thermocouples placed in the center of block C1 and just below the canister (TB503, 69 °C) and in block R5 (TB513, 73 °C). The temperature gradient over block R5 (between the radius 585 mm and 785 mm) is at the end of this measuring period about 0.68 °C/cm.

The temperature in the buffer is also measured with the Geokon sensors. The maximum temperature recorded with these sensors is about 69 °C at the end of this measuring period (PBU502 placed in the center of block C1 close to the canister).

The temperature in the buffer is also measured with the Wescor sensors. The maximum temperature recorded with these sensors is about 71 °C at the end of this measuring period.

### **7.2.5 Canister power (App. 5\page 213)**

The power of the canister in hole5 has been kept constant at 1800 W from the start 2003-05-08 until the beginning of September 2004 when the power was decreased to about 1770 W. During the period between December 6 (day 575) and December 15 (day588) the power to the canister was switched off. After that period the power was adjusted to about 1770 W again. At the beginning of December 2005 the power was decreased with 30 W to about 1740 W

Due to problems with the data collection system, data is missing for the first 45 days of the heating.

### **7.2.6 Temperature on the canister surface (App. 5\pages 214-216)**

The first diagram shows the maximum temperature, measured with the optical cables placed on the surface of the canister, plotted as function of time. The present maximum measured temperature on the canister surface is about 79 °C. The second diagram shows the distribution of the temperature along the optical cables at the end of this measuring period. With no damages on the optical cables this plot should have four curves. Only two curves with relevant values are presented here which indicates that the optical cables are damaged. The length of the cables on the canister surface is about 20 m. The variation of a few degrees is caused by the difference in temperature at the center and ends of the canister. The curves may thus be further corrected after completed calibration. Compared to the measurements of the canister temperature with conventional thermocouples (see chapter 7.2.4) the optical cables yield a higher maximum temperature

## **7.3 Deposition hole 6**

### **7.3.1 Total pressure**

#### **Geokon and Kulite (App. 6\pages 219-222)**

The results from two types of sensors are presented in the same plot.

The measured pressure range is from 0 to 11 MPa. Two sensors, PB624 and PB627 placed in the top block (C4) showed an increase in pressure with about 1.5 MPa when the drainage of the tunnel was closed. Three sensors placed in Block R1 and R2, PB603, PB606 and PB607, showed an increase in pressure during the whole measuring period. Three sensors placed in Block R5 and R6 are measuring a pressure of about 6 MPa at the end of this measuring period. Three of the sensors placed in Block R8 and R9, PB620, PB621 and PB623, showed a strong increase in pressure after the power was switched on again. All the sensors reacted also with a rapid decrease in pressure when the power to canister 6 was switched off for the second time. After the drop in pressure most of the sensors started to measure an increase in pressure even though the power was not switched on. The measured total pressure in Block R8 and R9 varies between 1.5 and 6 MPa at the end of this measuring period.

Nine sensors (eight Kulite and one Geokon) are out of order.

### **7.3.2 Relative humidity/Suction**

#### **Vaisala and Rotronic (App. 6\pages 223-229)**

The results from two types of sensors are presented in the same plot.

The sensors placed in the bottom block C1 show very small changes in RH with the time. At the end of this measuring period two sensors are measuring a relative humidity of about 87%.

Two sensors placed in block R1 and R2 indicated a very quick increase in RH when the drainage was closed.

One sensor in block R6 reacted strongly after the drainage was closed.

One sensor placed close to the canister in block R9 (WB645) indicates a drying of the buffer. The rest of the sensors in block R8 and R9 indicate a slowly wetting of the buffer up to the closing of the drainage. At that point a quick increase in RH was measured by several sensors.

Two sensors (WB649, WB650) placed in block R10 and at the top of the canister indicated an initial wetting of the bentonite and then a continuing drying. The two sensors stopped functioning around day 600 (when the drainage of the tunnel was closed).

The sensors placed in block C3 and C4 show very small changes in RH with the time.

Sensors WB606, WB634 and WB648 were out of order at the start of the heating phase and are not plotted in this report.

30 of the initial 37 installed sensors are out of order, some of them due to data logger problems.

### **Wescor Psychrometers (App. 6\page 230-234)**

Four of totally nine sensors installed in the rock wall are measuring suction in the rock at the end of this measuring period. Seven of totally 26 sensors installed in the buffer are beginning to measure a decrease in suction in the buffer.

### **7.3.3 Pore water pressure**

#### **Geokon and Kulite (App. 6\pages 235-237)**

All sensors except two yield very low pressures (below 0.2 MPa) One sensor placed in block R6 close to the outer radius of the block and one sensor placed in Block R1 show a pressure of about 0.40 MPa at the end of this measuring period.

Three sensors (Kulite) are out of order.

### **7.3.4 Temperature in the buffer (App. 6\pages 238-251)**

Three thermocouples (TB611, TB619 and TB627) are placed on the surface of the canister. TB611 placed close to the bottom of the canister showed a temperature at the end of this measuring period of about 64 °C while TB619 placed at the middle of canister showed a temperature of 71 °C. TB627 placed close to the top of the canister was measuring a temperature of 69 °C.

The maximum temperature in the buffer recorded at the end of this measuring period is 71 °C. It was measured in block R5, close to the canister (TB612). The temperature plot for this sensor indicates that the thermocouple is in contact with the canister. When this sensor is excluded the maximum temperature gradient over block R5 is about 0.51 °C/cm.

Eleven thermocouples are out of order.

The temperature in the buffer is also measured by the installed Geokon sensors. The maximum temperature recorded with these sensors at the end of this measuring period is about 69 °C (UB609 placed in block R2 close to the canister). Four sensors are out of order.

The temperature in the buffer is also measured with the Wescor sensors. The maximum temperature recorded with these sensors is about 71 °C at the end of this measuring period. The sensor is placed in block R5 close to the canister surface.

### **7.3.5 Canister power (App. 6\page 255)**

The power of the canister in hole 6 has been kept constant at 1800 W from the start 2003-05-08 to the beginning of September 2004 when the power was decreased to about 1770 W. During the period between December 6 (day 575) and December 15 (day588) the power to the canister was switched off. After that period the power was adjusted to about 1770 W. During a period of about 2 months (from August 2) the power was switched off again and after that the power was adjusted to 1770 W again. At the beginning of December 2005 the power was decreased with 30 W to about 1740 W.

Due to problems with the data collection system, data is missing for the first 30 days of the heating.

### **7.3.6 Temperature on the canister surface (App. 6\pages 256-258)**

The first diagram shows the maximum temperature plotted as a function of time. The average maximum measured temperature on the canister surface at the end of this measuring period is about 75 °C. The second diagram shows the distribution of the temperature along the optical cables at the end of this measuring period. The maximum temperature has decreased with about 9 °C after the switch off/switch on of the power at the end of year 2004. The temperature has all about recovered from the latest period when the power was switched off. With no damages on the optical cables this plot should have four curves. Only two curves with relevant values are available which indicates that the optical cables are damaged. The length of the cables on the canister surface is about 20 m. The variation of a few degrees is caused by the difference in temperature at the center and ends of the canister.

## **7.4 Backfill in Section 2**

### **7.4.1 Total pressure**

#### **Geokon (App. 7\page 261)**

All the total pressure sensors measured an increase in pore pressure, of about 1 MPa, after the drainage of the tunnel was closed. The highest total pressures before the closing of the drainage, 400 kPa, was measured by the sensor PFA13. This sensor is placed just above the bentonite surface in the deposition hole 6. The rest of the total pressure sensors measured very low pressures before the closing of the drainage. However, all installed sensors indicated a decrease in pressure when the drainage was opened again. The maximum measured pressure just after the opening of the drainage was about 0.4 MPa. All the sensors recorded a slow increase in pressure although the drainage was kept open. Just before the power to canister 6 was switched off again at the beginning of September 2006 the maximum recorded pressure was about 1 MPa. All the sensors indicated a decrease in pressure when the power to canister 6 was switched off. When the power was switched on the pressure started to slowly increase again and the maximum pressure recorded at the end of this measuring period is about 1.0 MPa.

#### **Kulite (App.7 \page 262)**

These sensors measured also an increase in total pressure of about 1 MPa due to the closing of the drainage. The highest pressure before the closing of the drainage was measured by the sensor PFA12, about 0.4 MPa. This sensor is placed just above the bentonite surface in deposition hole 6. The rest of the total pressure sensors measured very small pressures before the closing of the drainage. After the reopening of the drainage, all the sensors recorded a drop in total pressure. The measured pressure started to slowly increase although the drainage was kept open. When the power to canister 6 was switched off again at the beginning of September 2006 the maximum recorded pressure decreased to 0.6 MPa and after that the measured pressure started to slowly increase again and at the end of this measuring period the maximum recorded pressure was about 1.0 MPa.

#### **7.4.2 Suction (App. 7 \pages 263-269)**

The suction in the backfill is measured with Wescor psychrometers. Most of the psychrometers yield suction values between 2500 and 3500 kPa at the start of the test, which correspond to the initial suction at a water ratio in the backfill of 12%. Some sensors have clearly being wetted to almost fully saturation (suction below 1500 kPa) very short after the start of the test. These sensors (WFA12, WFA20, and WFA27) are placed close the rock surface. A decrease in suction and thus a wetting of the backfill was indicated by the rest of the sensors until the closing of drainage of the tunnel. All of the still working sensors were after this event showing a quicker decrease in suction. None of the installed sensors are giving reliable values at the end of this measuring period. The position of WFA14 is not clear and the sensor is not plotted in this report.

#### **7.4.3 Pore water pressure**

##### **Geokon (App. 7\pages 270-272)**

All the sensors, except one (UFA11), showed an increase in pore pressure, about 1.5 MPa, after the closing of the tunnel drainage. Before this event the sensors recorded very low pressures. After the drainage was reopening all sensors placed close to the tunnel surface indicated a slow increase in pore pressure. Just before the power to canister 6 was switched off again at the beginning of September 2006 the average recorded pressure was 0.5 MPa. The pressure dropped then with about 0.2 MPa. The average pressure for these sensors at the end of this measuring period was 0.4 MPa.

##### **Kulite (App. 7\page 273)**

Three of the sensors showed an increase in pore pressure, about 1.5 MPa, after the closing of the tunnel drainage. Before this event the sensors recorded very low pressures. After the drainage was reopened again, the two still working sensors measured maximum values of about 0.55 MPa. When the power to canister 6 was switched off again the pressures dropped with about 0.2 MPa. The still working sensor is measuring pressures of about 0.5 MPa at the end of this measuring period.

Three sensors are out of order.

#### **7.4.4 Temperature (App. 7\pages 274-276)**

The temperature in the backfill ranges from 19 to 30 °C. The highest temperatures is as expected measured above the buffer in hole 5. When the power to canister 6 was switched off at the beginning of September 2006 the temperature in the backfill close to canister in deposition hole 6 dropped with about 2°C but is now on the same level as before the power was switched off.

### **7.5 Temperature in the rock**

#### **7.5.1 Near hole 5 (App. 5\pages 210-212)**

The maximum temperature in the rock (54 °C) is measured by TROA5055 located at rock surface near the center of the canister in deposition hole 5.

Six sensors show suddenly increase in temperature with (2 degree) probably due to data logger problems during a period of about 100 days.

### **7.5.2 Near hole 6 (App. 7 pages 252-254)**

The maximum temperature in the rock (54 °C) was measured by TROA6055 just before the power to canister 6 was switched off. The sensor is located at rock surface near the center of the canister in deposition hole 6. All the sensors placed close to deposition hole 6 measured a drop in temperature when the power was switched off at the beginning of September 2005 but have now after the power been switched on again almost reached the same level.

## **7.6 Analyze of data from Section 2**

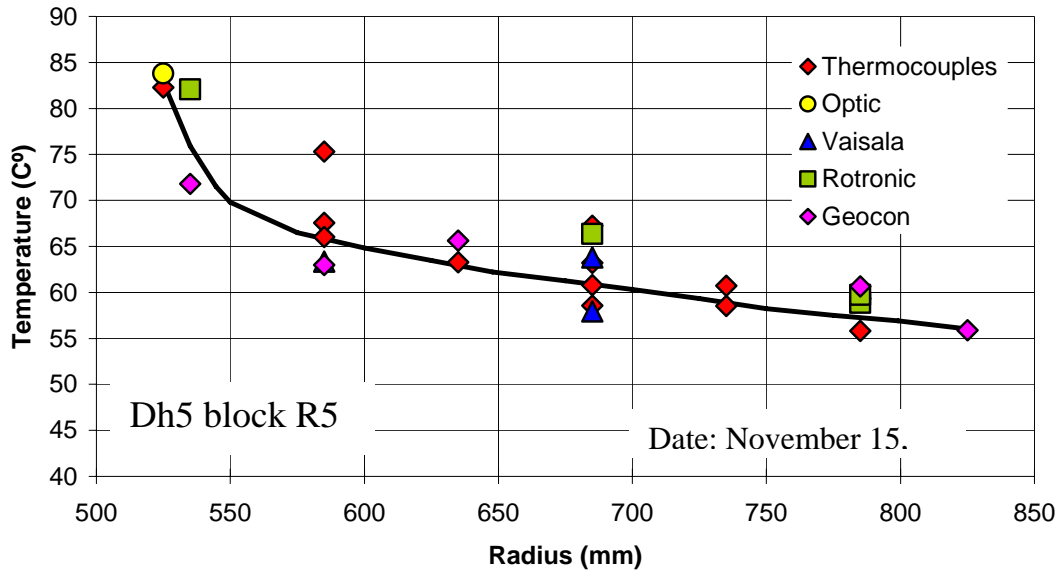
### **7.6.1 Deposition hole 5**

The saturation of the buffer in deposition hole 5 indicated by both RH sensors and total pressure sensors is complex. Some total pressure sensors indicate rather high total pressures (higher than 2.5 MPa) while others measure very low pressures. The sensors giving high pressures are placed both in block C1, R5 and R10. Common for all the sensors is that they are placed in direction A to B in the deposition hole (south-west direction). Also those RH-sensors measuring relative humidity of ~100% are placed in this direction. In other parts of the buffer most of the sensors (both RH-sensors and total pressure sensors) indicate a slow wetting of the buffer with time. Although the sensors reacted rather strongly just before and after the power was switched on and off at the beginning of December 2004, the saturation rate indicated by the sensors is not changed radically over the time. One sensor (PB510), measuring the total pressure in block R5 at the inner slot towards the canister, measured at the end of this measuring period (day 1718) a pressure of about 1200 kPa. This sensor started to react around day 200 which might be an indication of the time when the inner slot was closed.

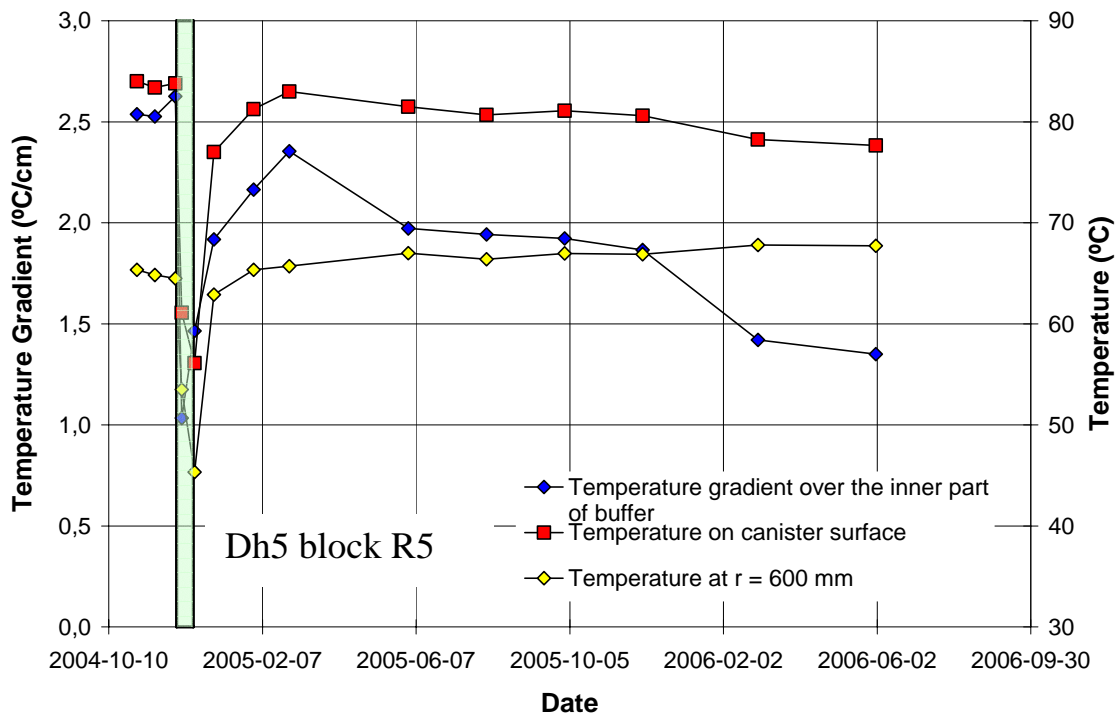
In Figure 7-1 the temperature for deposition hole 5 is plotted as function of the radial distance from the center of the deposition hole at mid height of the canister. Compared the corresponding plots for deposition hole 3 these plots do not show a drop in temperature between the surface of the canister and the buffer (inner diameter of the ring) although the temperature gradient is higher close to the canister surface. The temperature on the canister surface is also much lower compared to canister 3. These measurements indicate that the initial slot between the buffer and the canister of about 10 mm is not present anymore, but the closing of the slot is not associated with the high pressures generated in the buffer and backfill at the closing of the tunnel drainage.

The temperature gradient over the inner part of the buffer together with the temperature on the canister and the temperature at the radius of 600 mm in the ring shaped block R5 are plotted as function of time in Figure 7-2. The shaded part of the plot is representing the time when the power to the canisters was switched off. The plot shows that both the temperature and the temperature gradient were affected very little by the switch off/on of the power.

The temperature gradient over the outer part of the buffer is plotted in Figure 7-3. After the power was switched on again also this gradient stabilized on the same level as before the power was switched off.

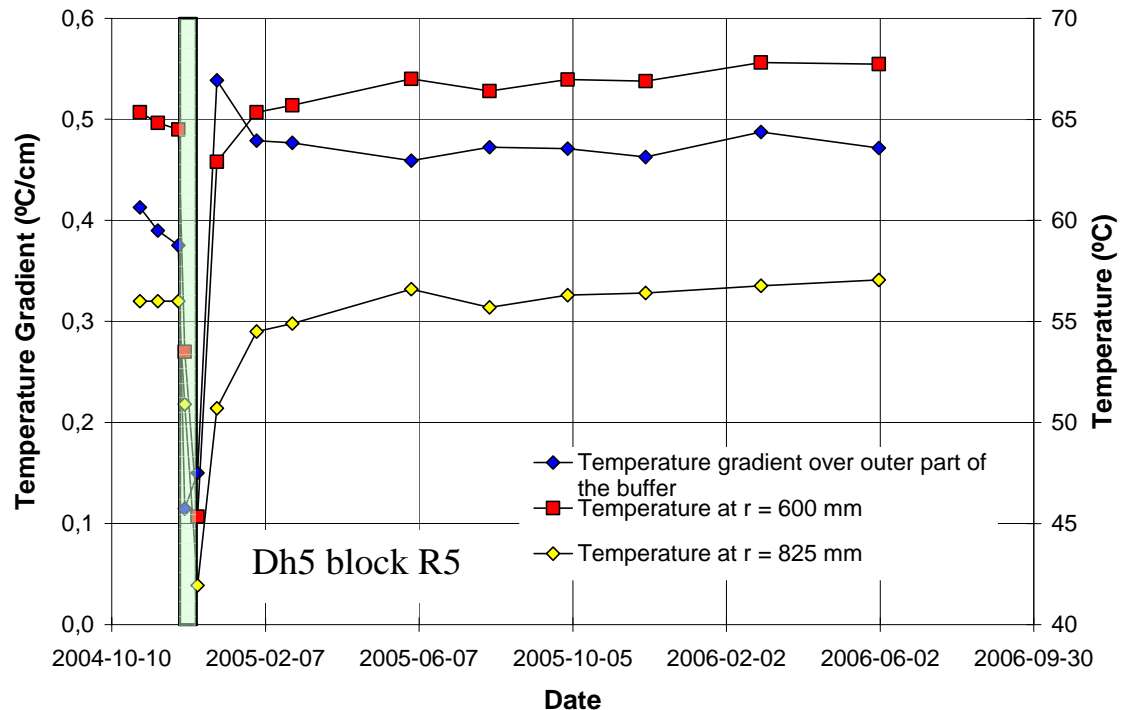


**Figure 7-1.** The temperature in block R5 in Dh 5 as function of radius from the center of the deposition hole on November 15, 2004.



**Figure 7-2.** The temperature and temperature gradient over the inner part of the buffer plotted as function the date in deposition hole 5 block R5.





**Figure 7-3.** The temperature and temperature gradient over the outer part of the buffer plotted as function the date in deposition hole 5 block R5.

### 7.6.2 Deposition hole 6

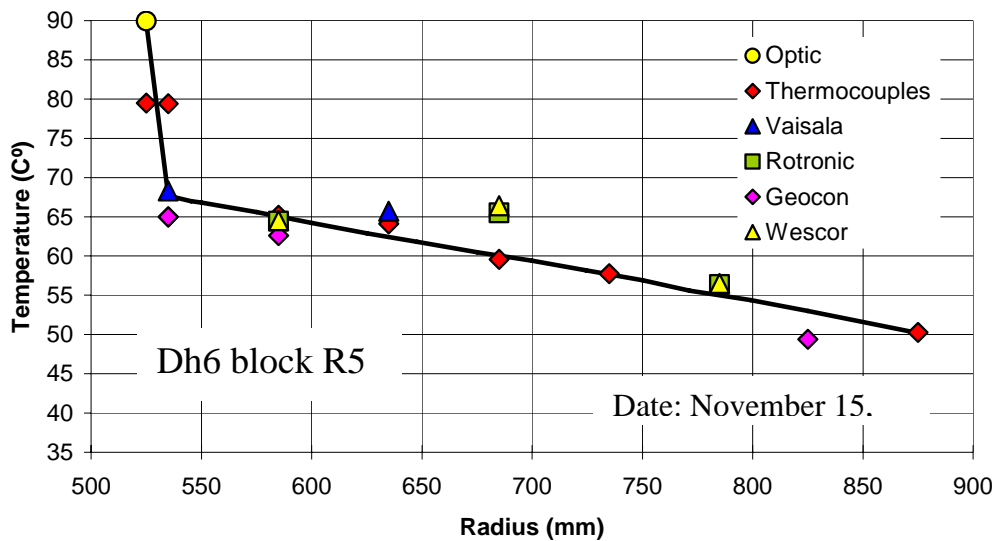
The saturation of the buffer in deposition hole 6 was affected by the quick increase in pressure when the drainage of the tunnel was closed as indicated by both RH sensors and total pressure sensors. The total pressure was also affected when the power was switched off again at the beginning of September 2005. The drop in total pressure was very large and rapid and the pressure started to increase before the power to the canister was switched on again. When the power was switched on pressure increased very fast to the same level as before the power was switched off. This course of events is indicating that the change in total pressure is an affect of the changes in water volume in the bentonite caused by variation in temperature.

The temperature in the buffer for deposition hole 6 is plotted as function of the radial distance from the center of the deposition hole at mid height of the canister in Figure 7-4 at November 15, 2004 which was before the high pore pressure in the tunnel was observed. Compared to the corresponding plots for deposition hole 5 these plots indicate a drop in temperature between the surface of the canister and the buffer (inner diameter of the ring). The temperature on the canister surface measured with the optical system is also much higher compared to canister 3. These measurements indicate that the initial slot between the buffer and the canister of about 10 mm was still open when the drainage was closed. Corresponding plot (Figure 7-5) some time after the drainage was opened again shows that the temperature on the surface of the canister has dropped with about 10 °C.

The temperature gradient over the inner slot is shown in Figure 7-6 as function of time. The shaded parts of the plot represents the time when the power to the canister was switched off. The plot shows that both the temperatures and the temperature gradient were affected very much by the closing/opening of the drainage which is indicating that the inner slot was closed when water entered the slot. The temperatures and the gradient were also affected when the power to the canister was switched off for the second time. Both the temperatures and the gradient are approaching the same levels at the end of this measuring period as before the power was switched off.

The closing of the gap is also affecting the temperature development in different part of the buffer since the relation between the heat leaving the end parts of the canister and the heat leaving the cylindrical part of the canister was changed when the gap was closed. Directly after the installation the buffer was in good contact with the ends of the canister while the slot was isolating the rest of canister surface from the buffer. When the gap was closed, more of the generated heat was leaving the cylindrical part of the canister resulting in a higher temperature in the buffer at the central part of the deposition hole and a lower temperature in the buffer at the ends of the canister.

The temperature gradient over the outer part of the buffer is plotted in Figure 7-7. This gradient was also affected when the power was switched off. After the power was switched on again this gradient was stabilized on the same level as before the power was switched off.



**Figure 7-4.** The temperature in block R5 in Dh 6 as function of radius from the center of the deposition hole on November 15, 2004.

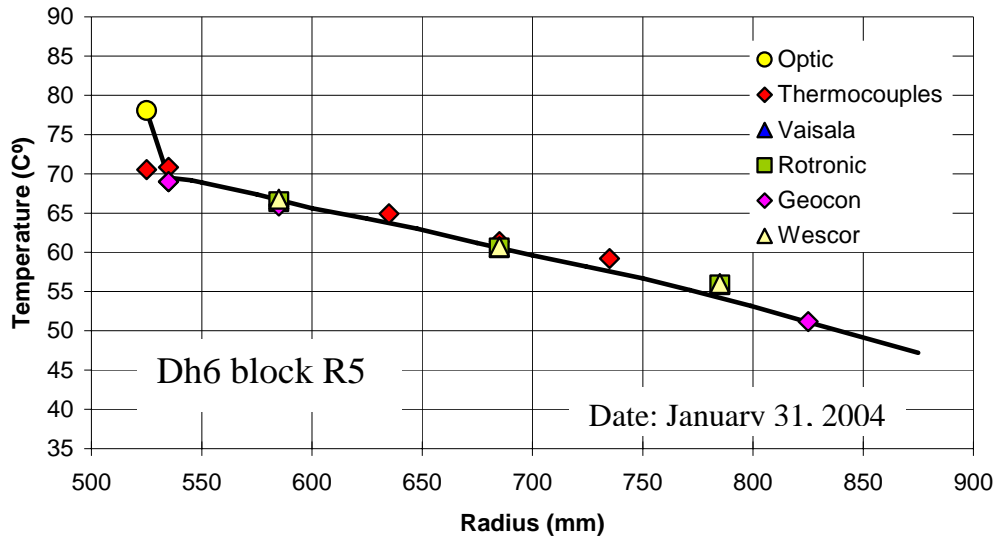


Figure 7-5. The temperature in block R5 in Dh 6 as function of radius from the center of the deposition hole on January 31, 2005.

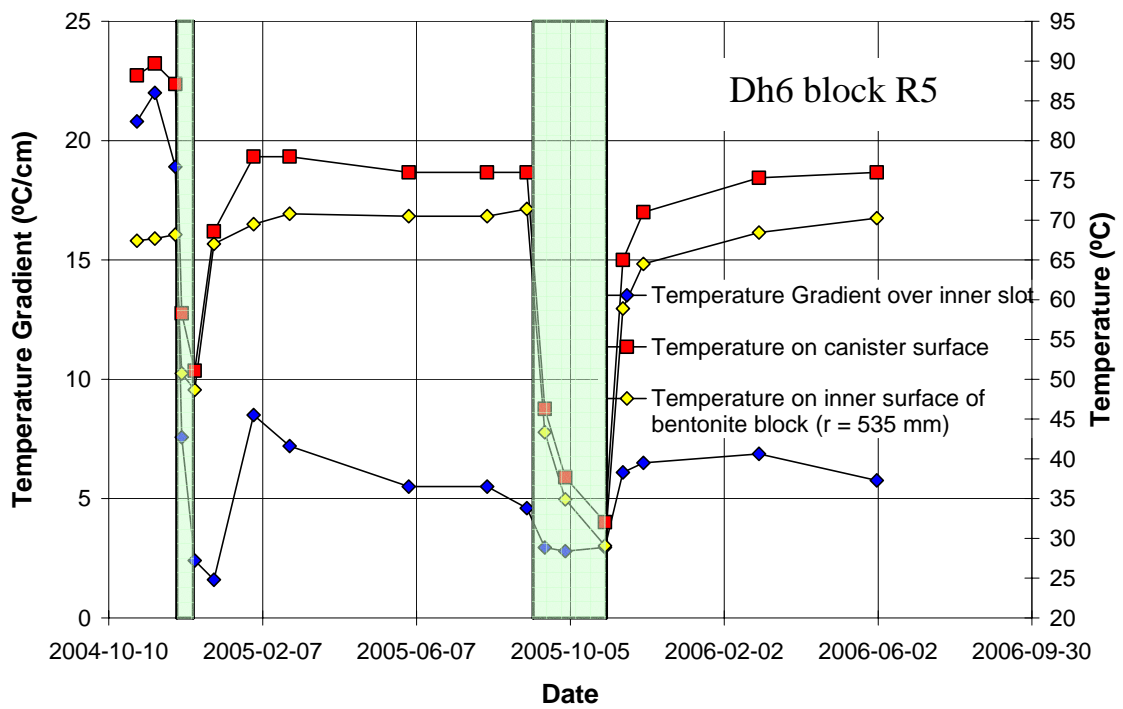
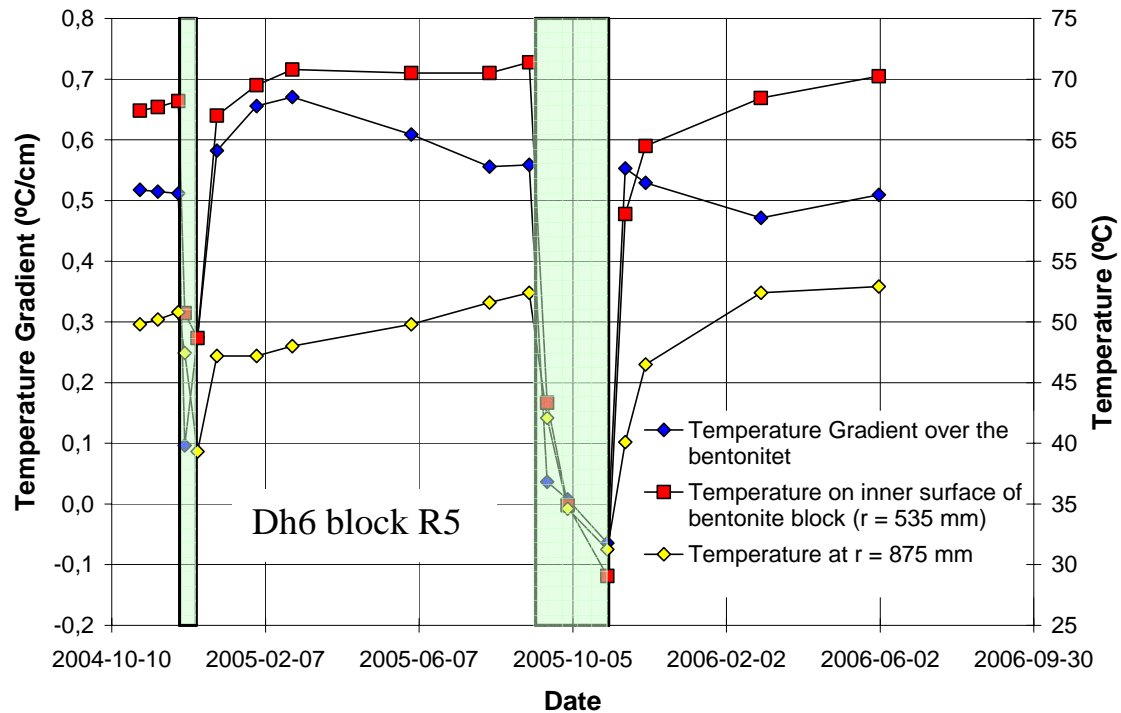


Figure 7-6. The temperature and temperature gradient over the inner slot plotted as function the date in deposition hole 6 block R5.



*Figure 7-7. The temperature and temperature gradient over the buffer plotted as function the date in deposition hole 6 block R5.*

### 7.6.3 Backfill

The pore pressure, measured both with total and pore pressure transducers placed in the backfill, increased fast from a low level when the drainage of the tunnel was closed. This affected the rate in which the backfill was saturated measured both with soil psychrometers and with resistivity measurements in the backfill. After the drainage was opened again the pore pressure stabilized on a higher level than before the drainage was closed. Most of the installed soil psychrometers measure very low suction values after the closing/opening of the drainage witch indicates that the backfill is close to fully saturated.

## References

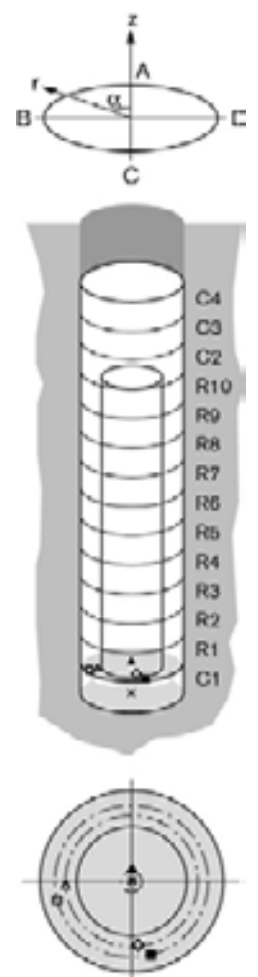
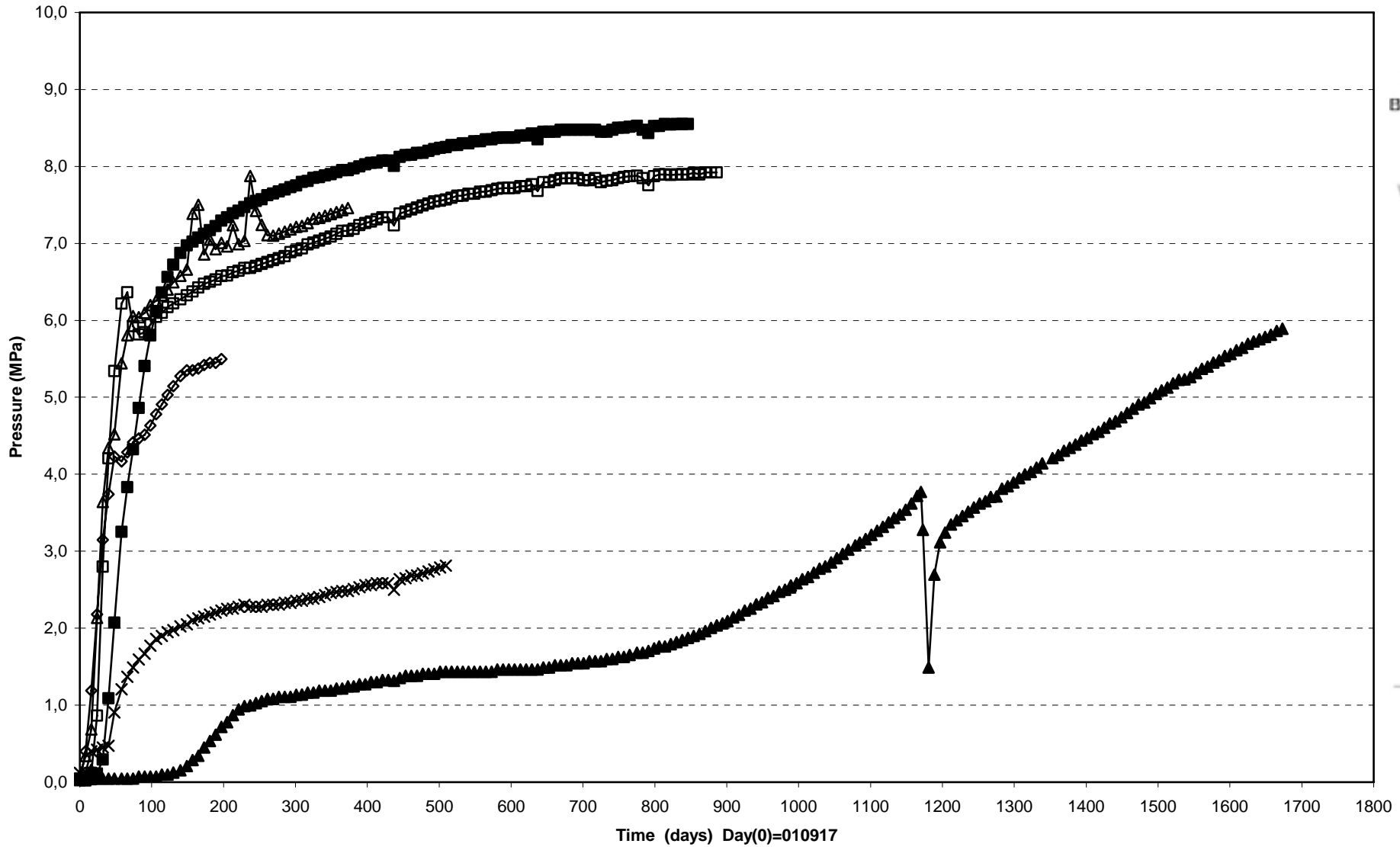
- /1-1/ **Börgesson L, Sanden T.** Report on instrument positions and preparation of bentonite blocks for instruments and cables in section 1, February 2001. SKB IPR-01-20
- /2-1/ **Börgesson L, Sanden T.** Instrumentation of buffer and backfill in Section 2 ,January 2003. SKB IPR-03-21

# Appendix 1

Dep. hole 1

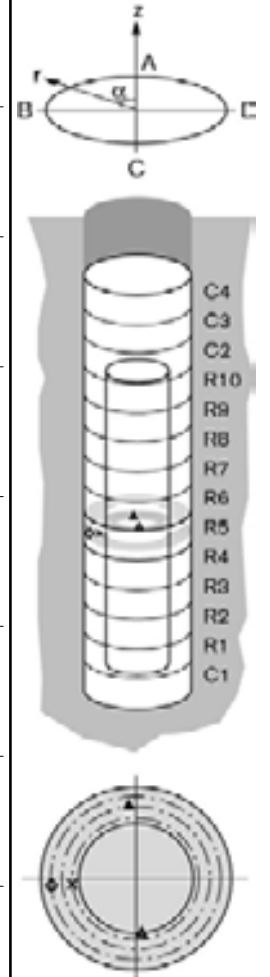
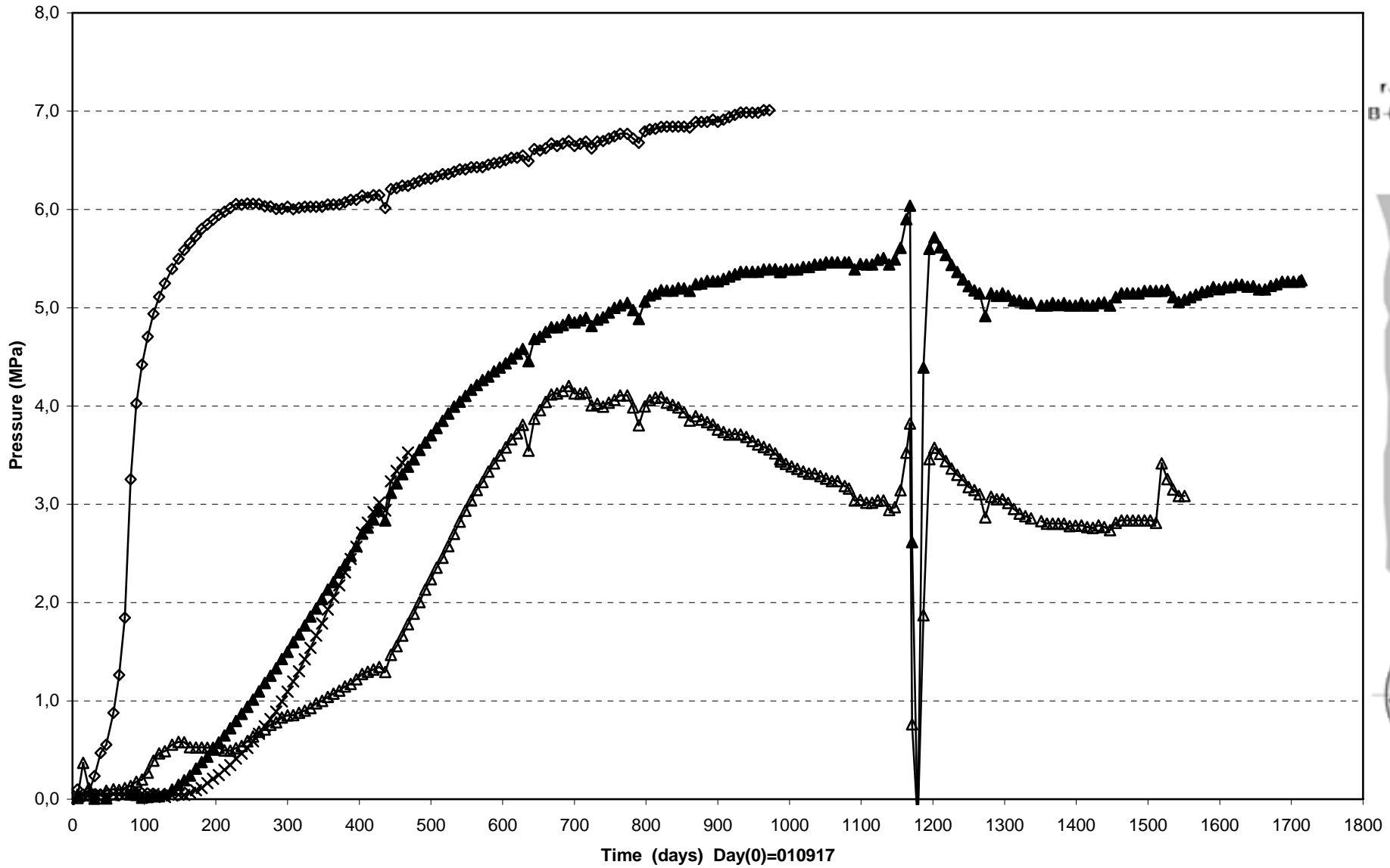


Prototype\Hole 1\Cyl.1 (010917-060601)  
Total pressure - Geokon



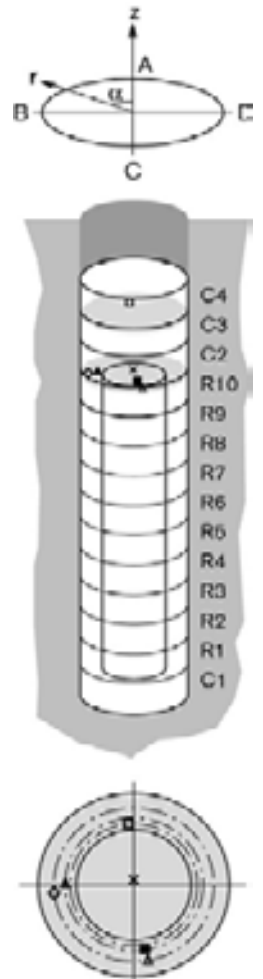
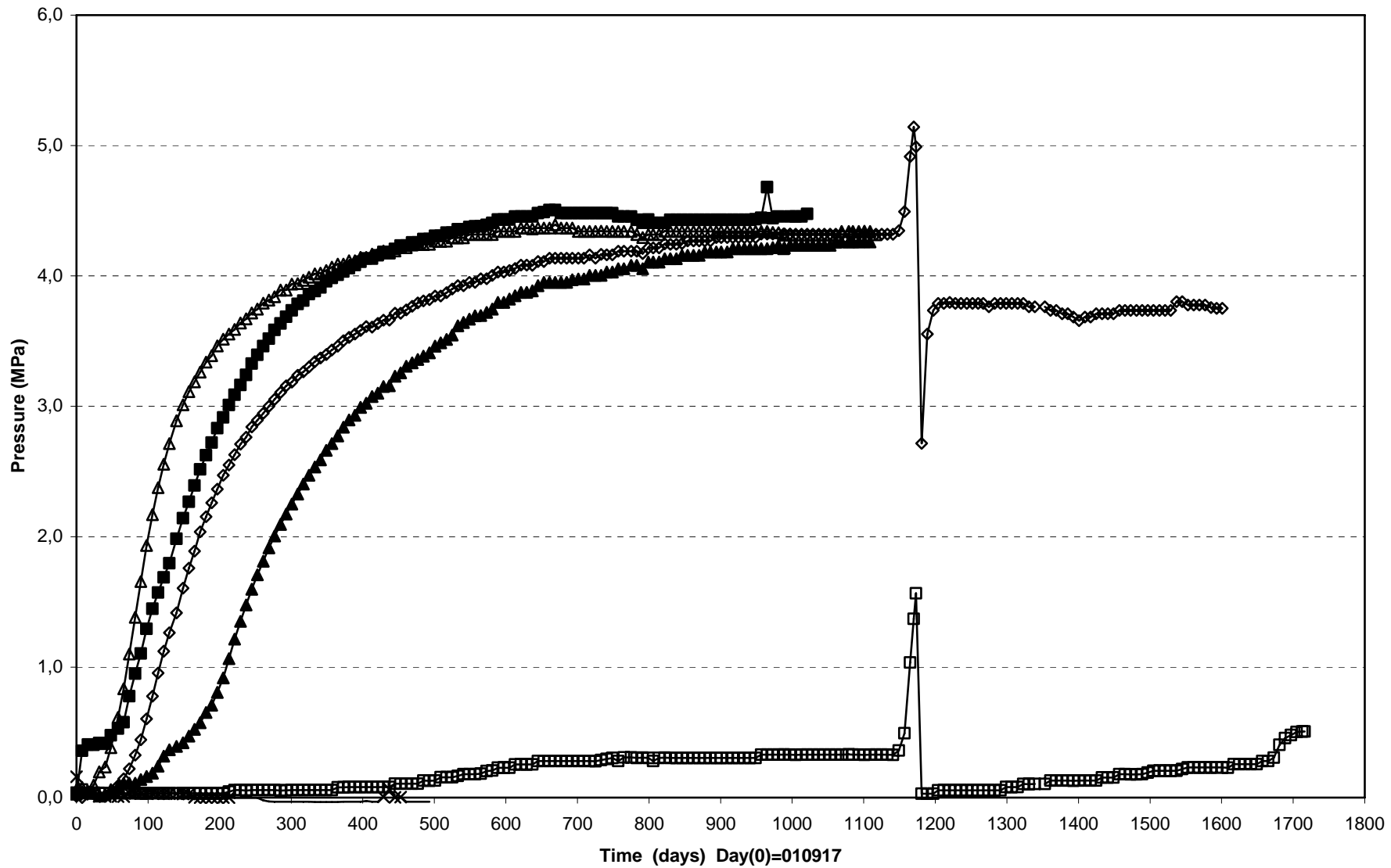
—x— PBU10001(0°\0°\0)	—▲— PBU10002(0.504\0°\0.100)	—◇— PBU10008(0.504\185°\0.635)
—△— PBU10006(0.504\95°\0.635)	—□— PBU10007(0.504\105°\0.735)	—■— PBU10009(0.504\195°\0.735)

Prototype\Hole 1\Ring5 (010917-060601)  
 Total pressure - Geokon

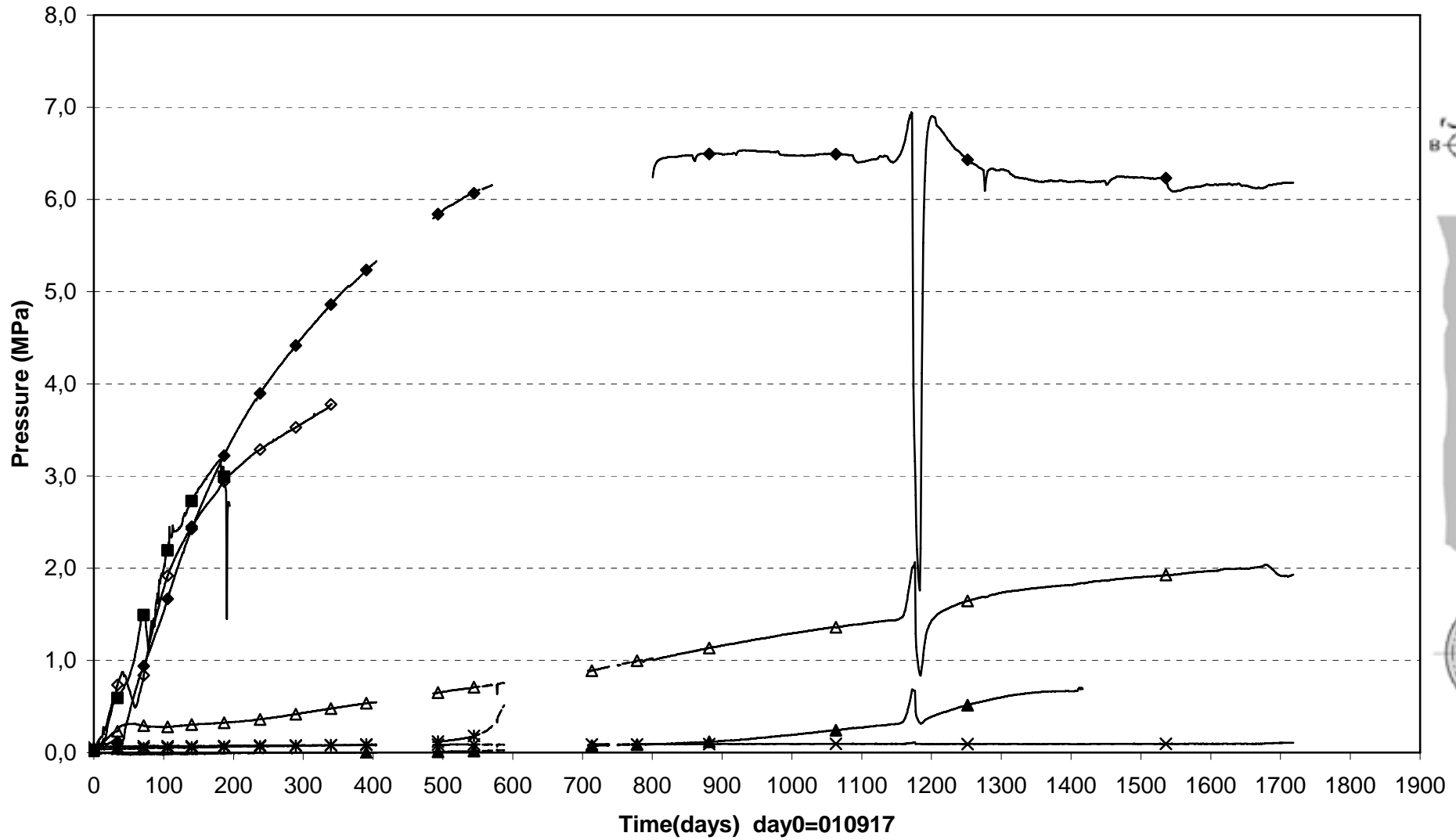




Prototype\Hole 1\ Ring10 and Cyl.3 (010917-060601)  
 Total pressure - Geokon

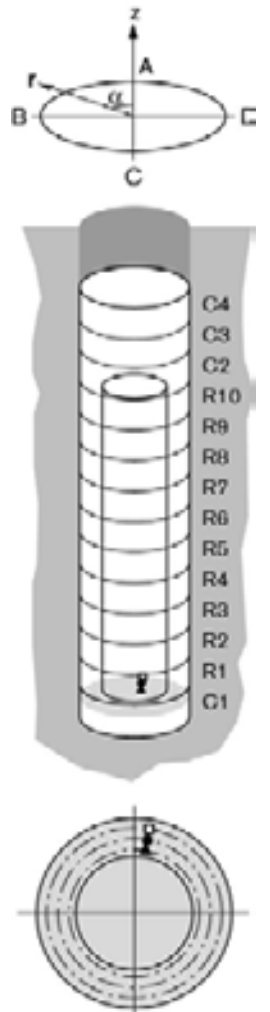
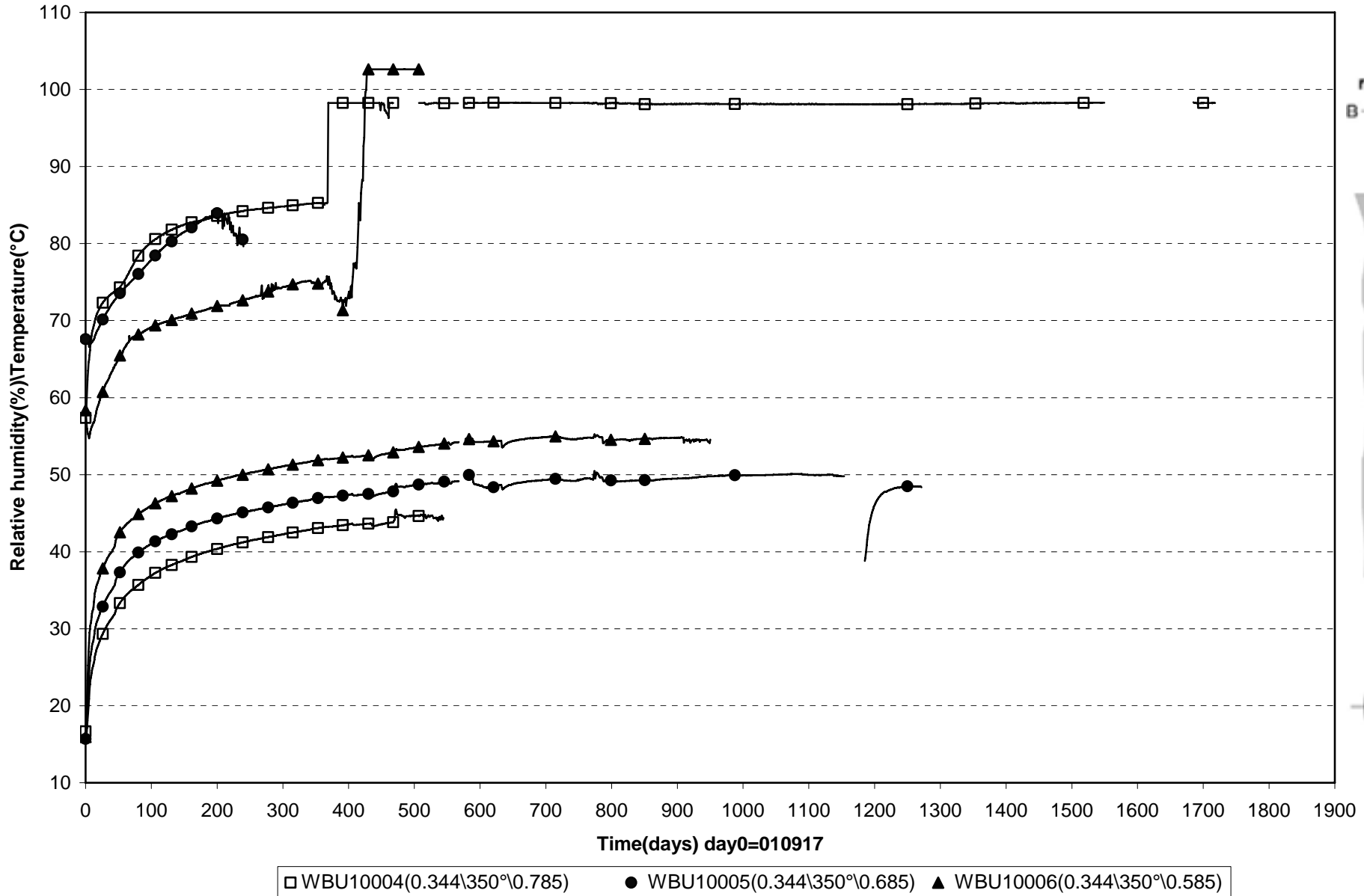


Prototype\ Hole 1 (010917-060601)  
Total pressure - Kulite

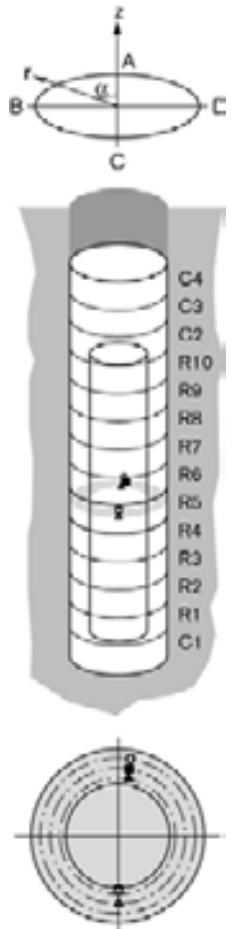
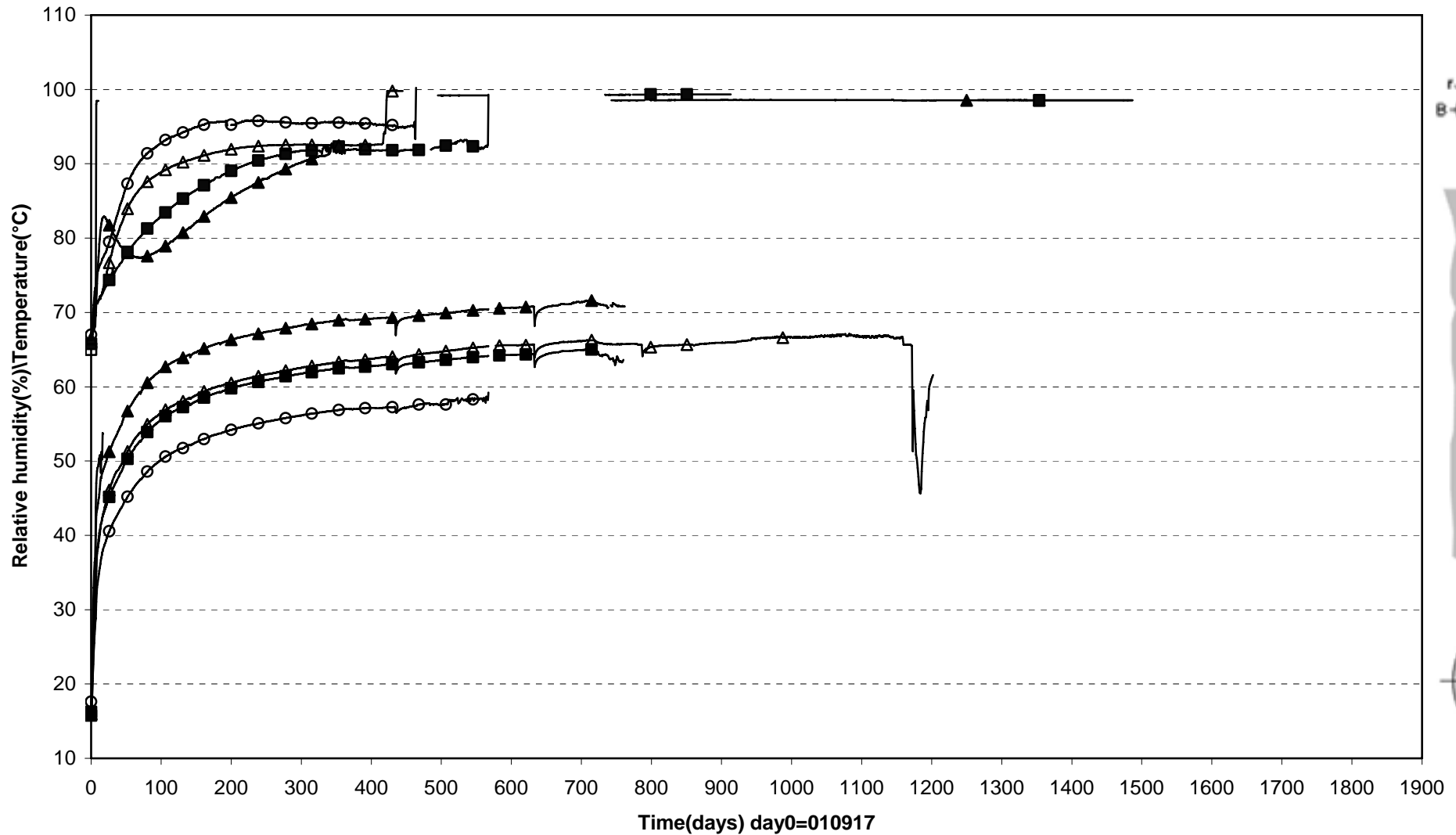


■ PBU10004(0.504\5°\0.685)    ◇ PBU10005(0.504\5°\0.785)    ◆ PBU10012(3.030\5°\0.785)    ▲ PBU10019(5.558\5°\0.685)  
 △ PBU10020(5.558\5°\0.785)    × PBU10025(6.317\0°\0.050)    \* PBU10027(7.076\0°\0.050)

Prototype\Hole 1\Cyl.1 (010917-060601)  
Relative humidity - Vaisala

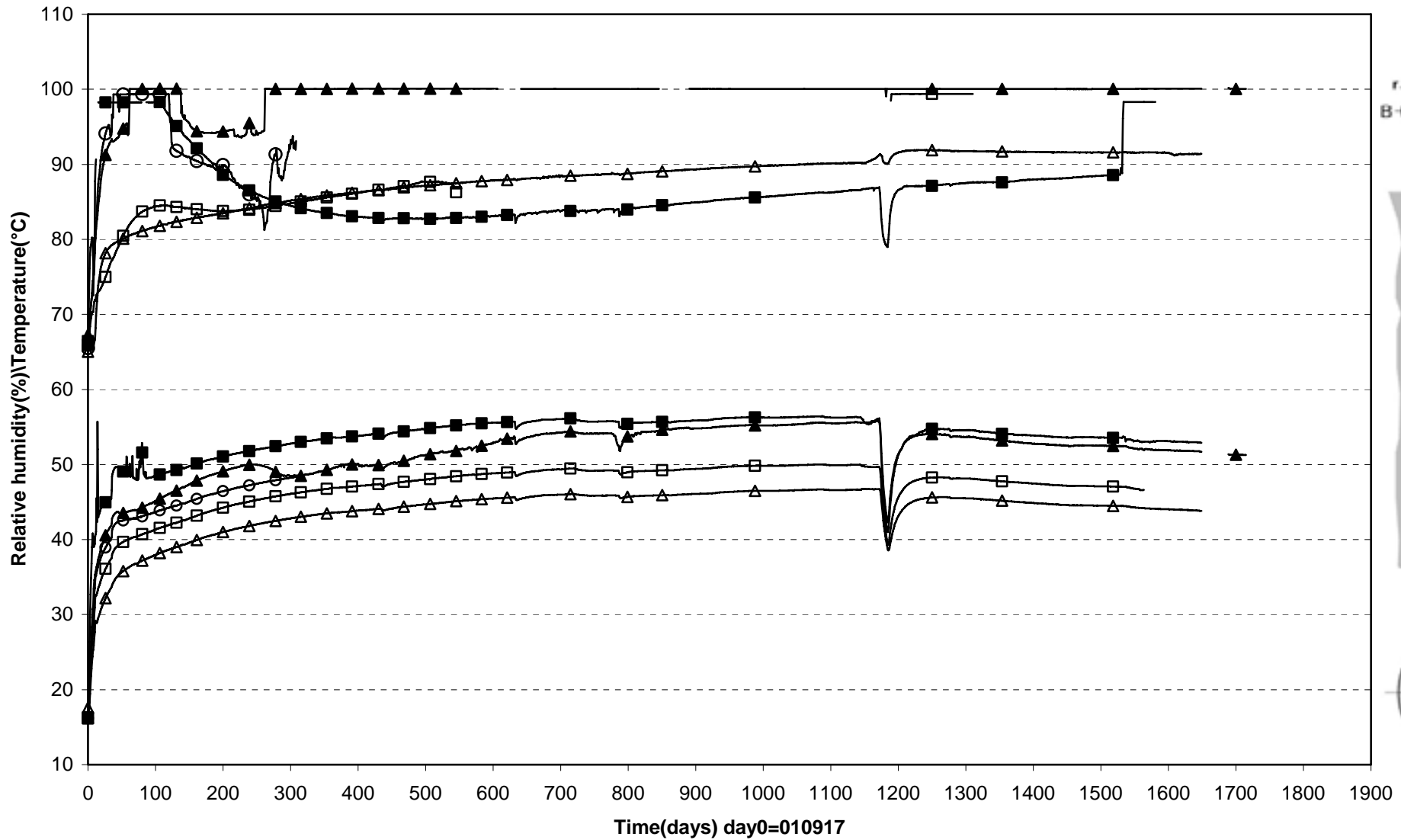


Prototype\Hole 1\Ring.5 (010917-060601)  
Relative humidity - Vaisala



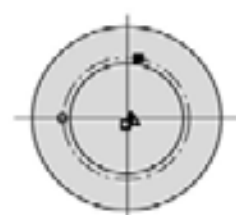
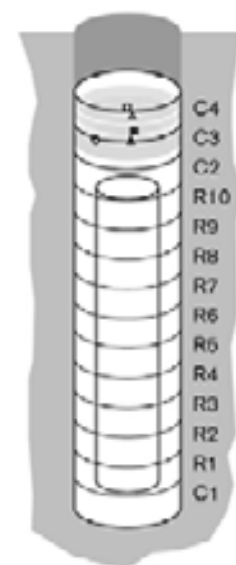
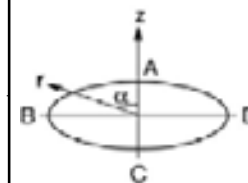
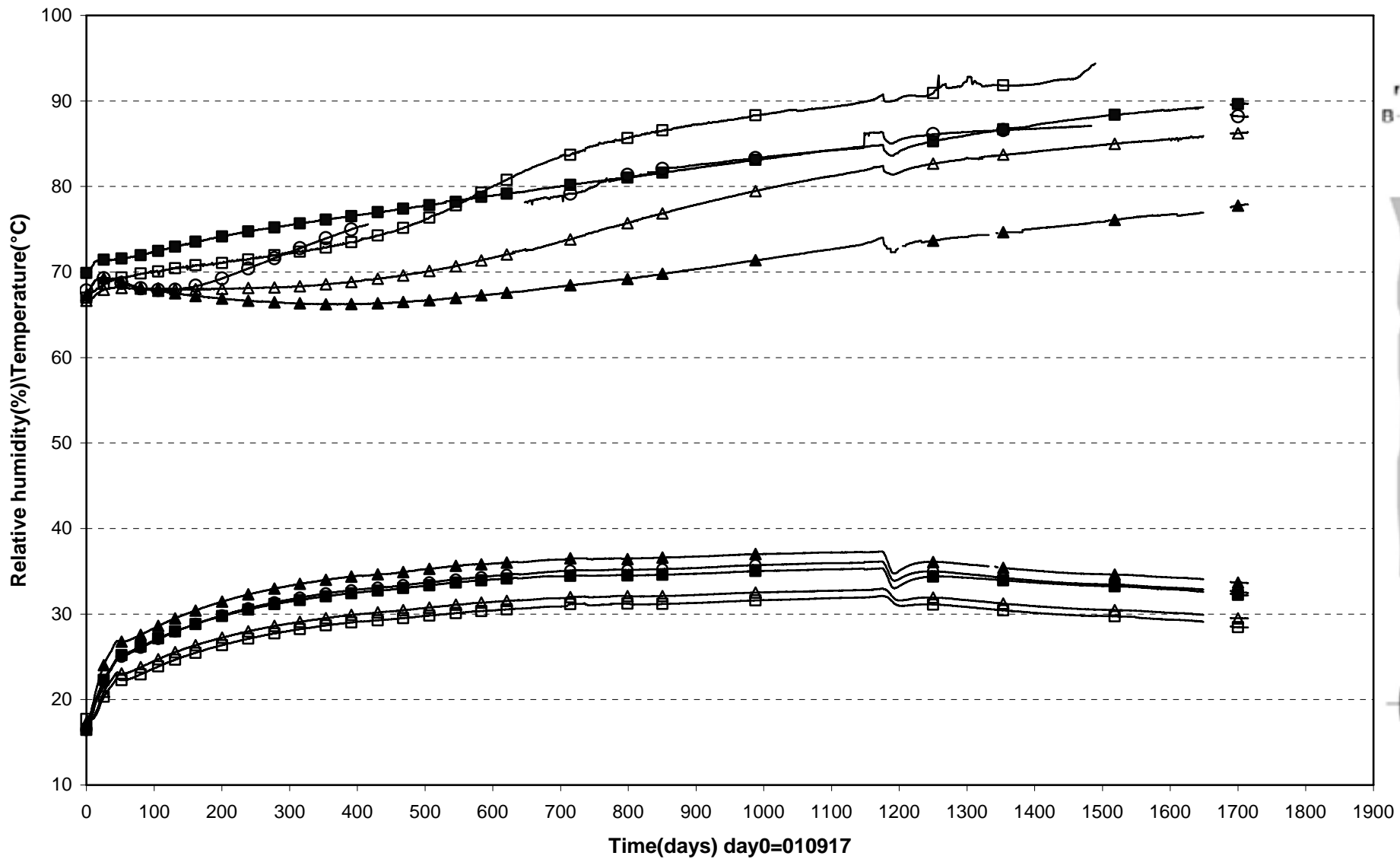
▲ WBU10013(2.870\350°\0.585)	■ WBU10014(2.870\350°\0.685)	○ WBU10015(2.870\350°\0.785)
□ WBU10019(2.870\180°\0.535\In the slot)	△ WBU10020(2.870\180°\0.685)	

Prototype\Hole 1\Ring10 (010917-060601)  
Relative humidity - Vaisala



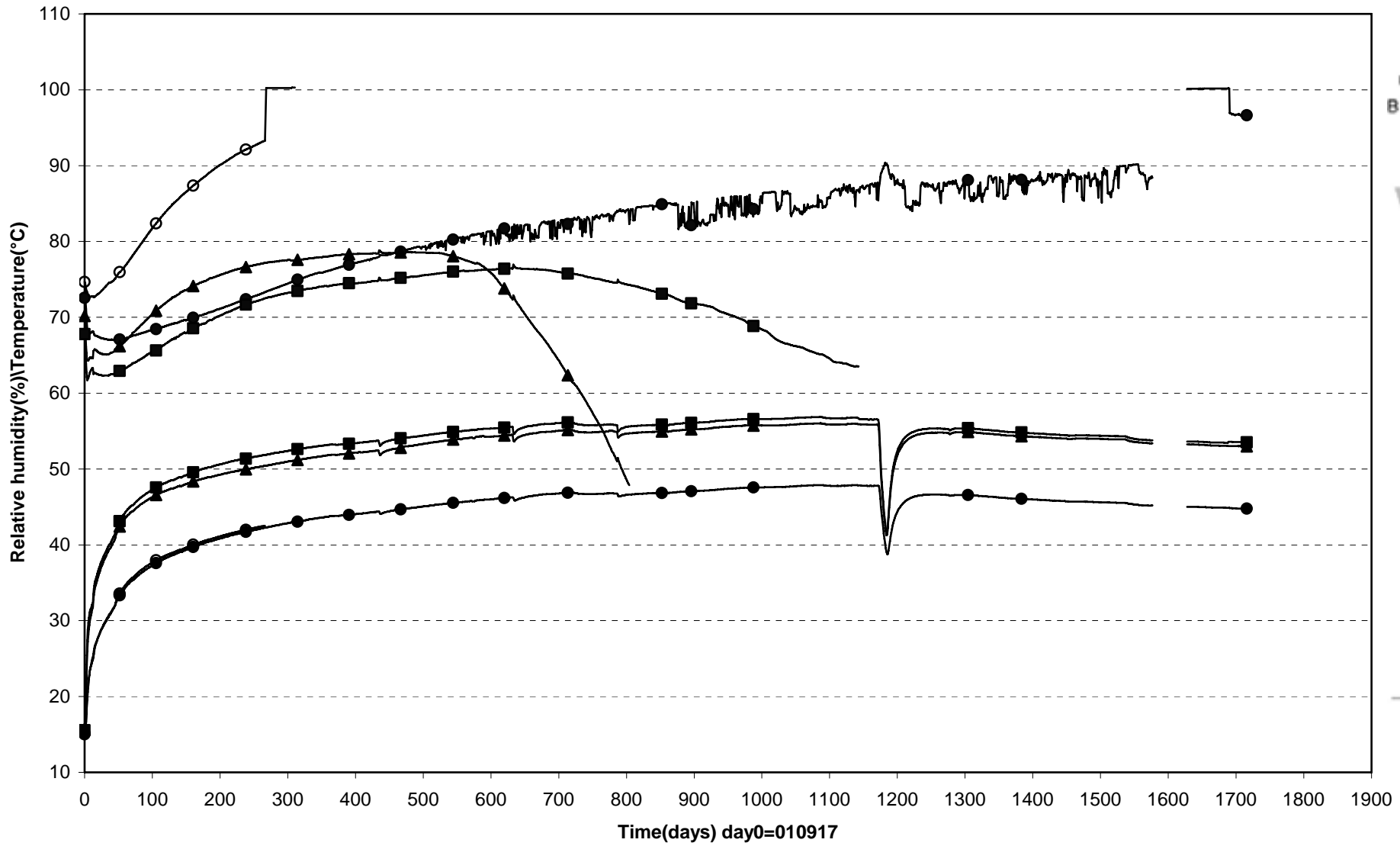
■ WBU10023(5.428\180°\0.362) ○ WBU10024(5.398\350°\0.585) □ WBU10025(5.398\350°\0.685) △ WBU10026(5.398\350°\0.785) ▲ WBU10030(5.398\170°\0.585)

Prototype\Hole 1\Cyl.3 and Cyl.4 (010917-060601)  
Relative humidity - Vaisala



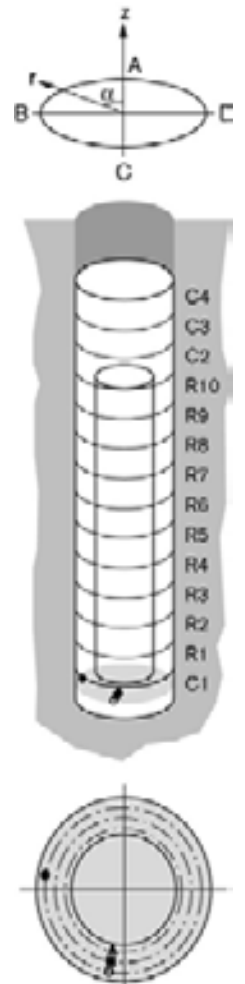
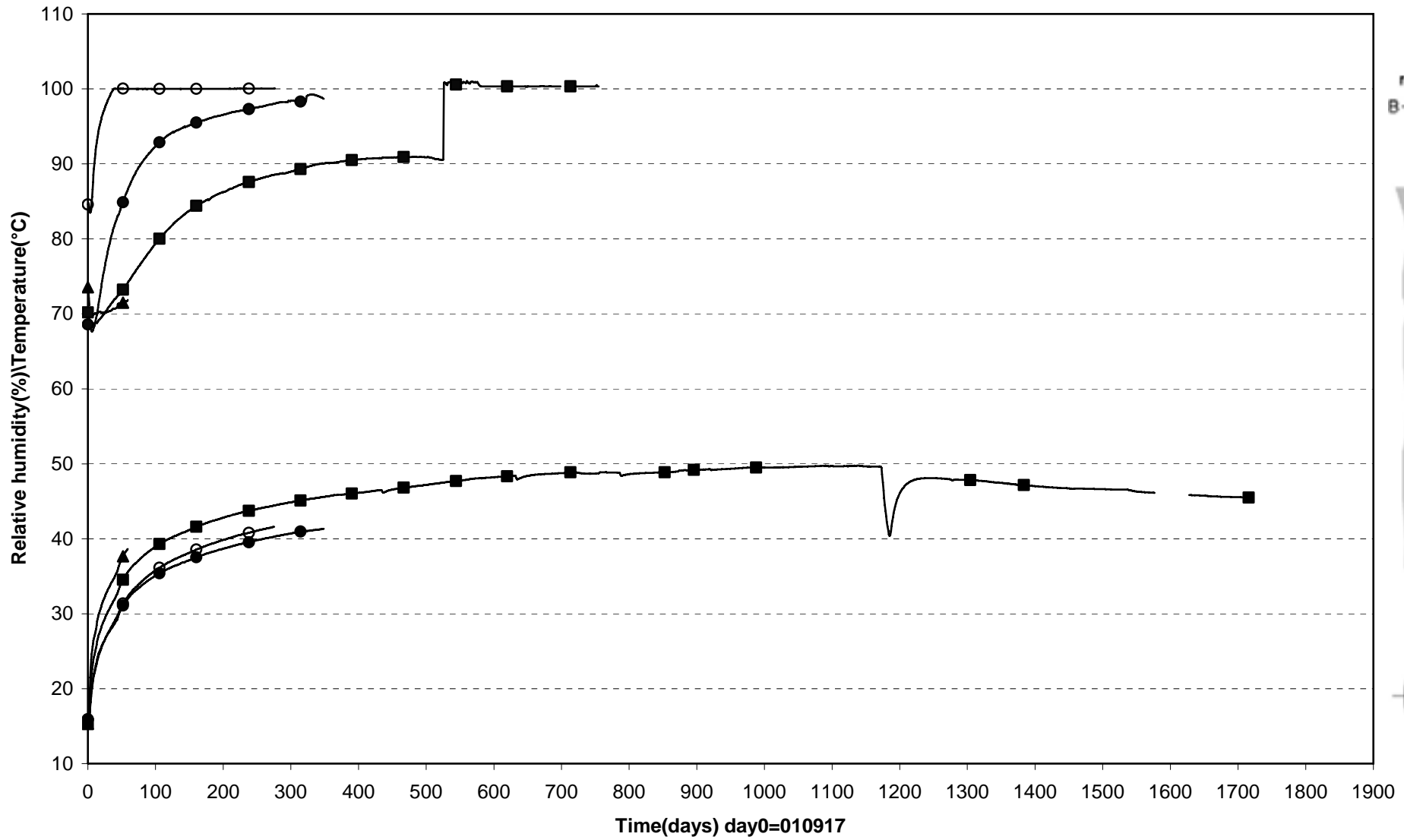
▲ WBU10032(6.317\270°\0.050) ■ WBU10033(6.317\350°\0.585) ○ WBU10034(6.317\90°\0.585) □ WBU10036(6.916\180°\0.050) △ WBU10037(6.756\270°\0.050)

Prototyp\Hole 1\Cyl.1 (010917-060601)  
 Relative humidity - Rotronic



● WBU10001 (0.054\180°\0.050) ▲ WBU10002 (0.254\0°\0.400) ■ WBU10003 (0.254\180°\0.100) ○ WBU10008(0.254\80°\0.685)

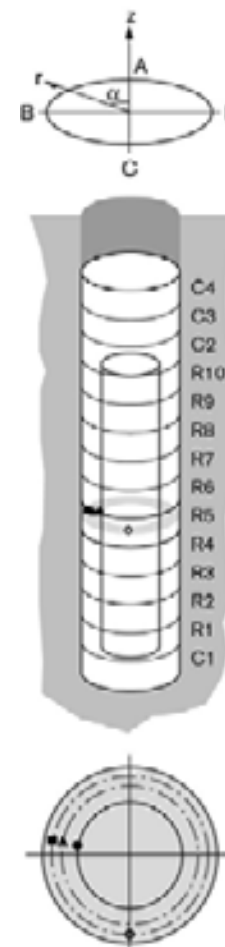
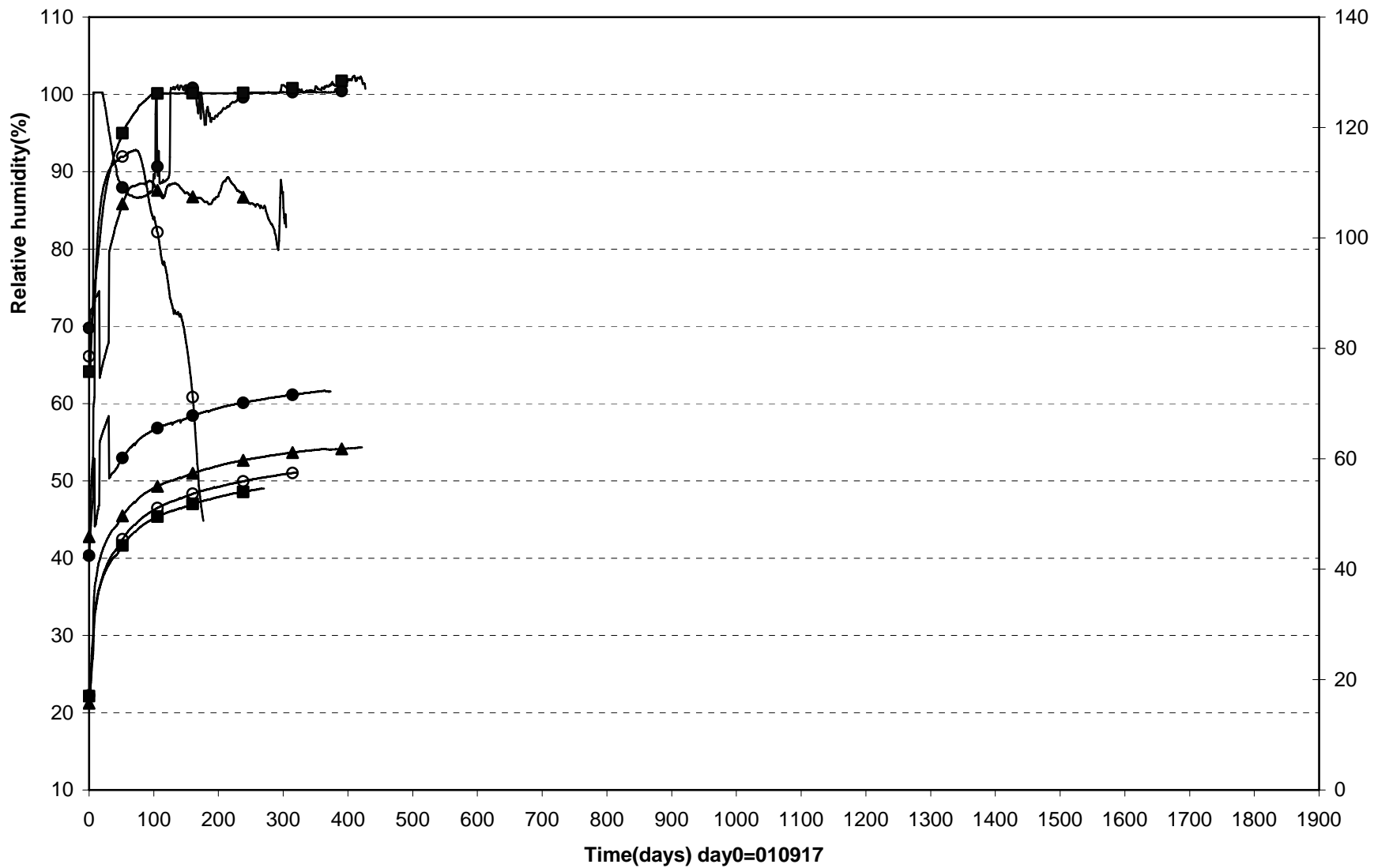
Prototyp\Hole 1\Cyl.1 (010917-060601)  
 Relative humidity - Rotronic



● WBU10009(0.254\80°\0.785) ▲ WBU10010(0.254\170°\0.585) ■ WBU10011(0.254\170°\0.685) ○ WBU10012(0.254\170°\0.785)

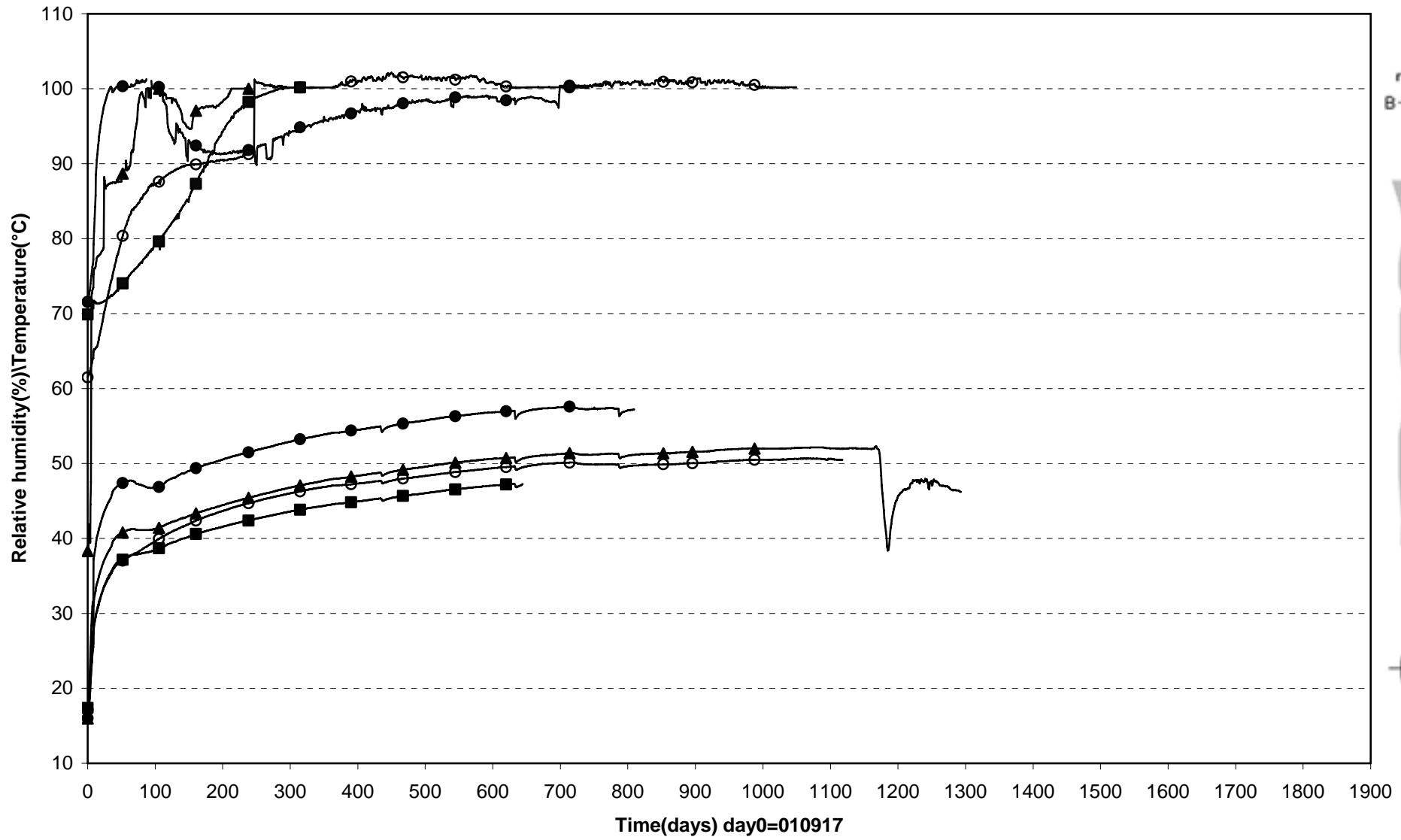


Prototyp\Hole 1\Ring.5 (010917-060601)  
Relative humidity - Rotronic

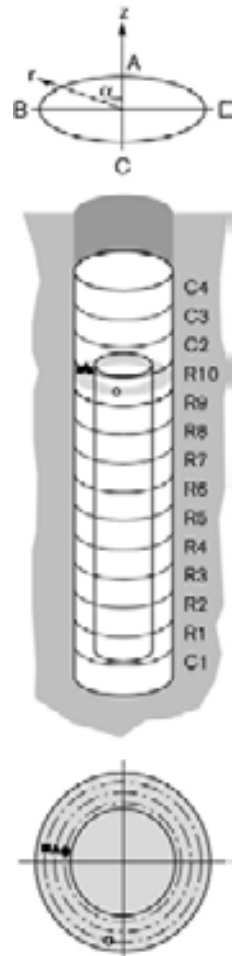


● WBU10016(2.780\80°\0.535) ▲ WBU10017(2.780\80°\0.685) ■ WBU10018(2.780\80°\0.785) ○ WBU10021(2.780\180°\0.785)

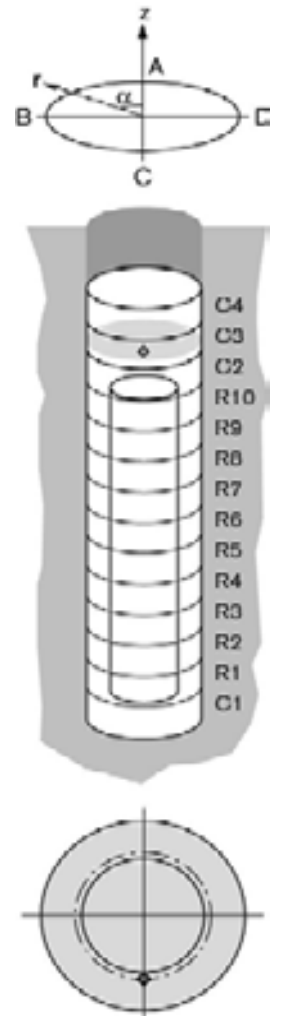
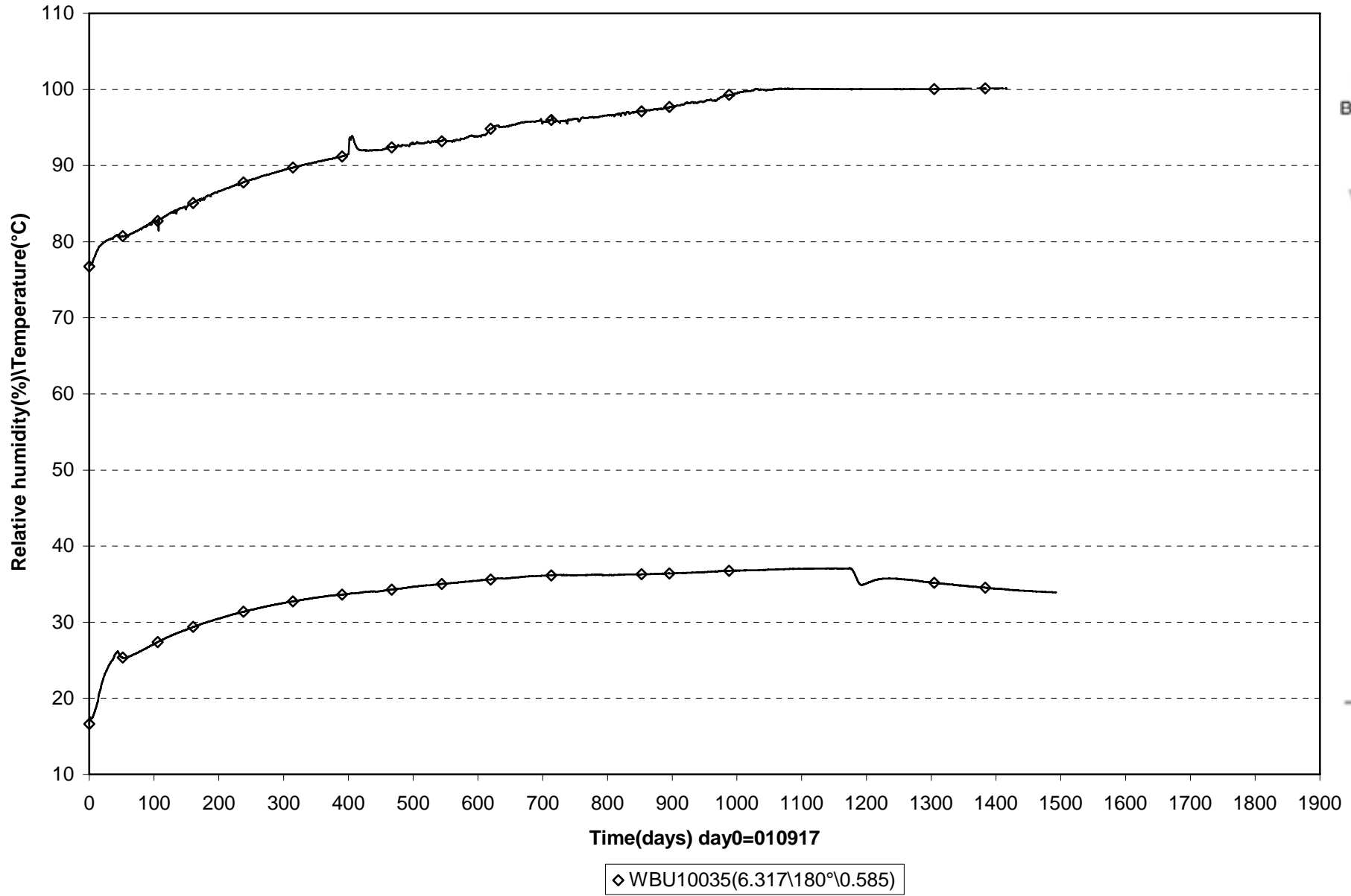
Prototyp\Hole 1\Ring10 (010917-060601)  
 Relative humidity - Rotronic



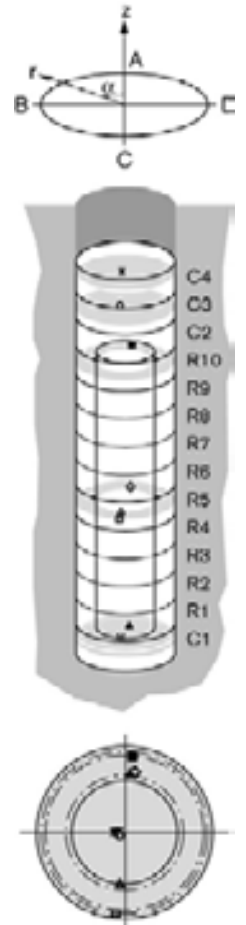
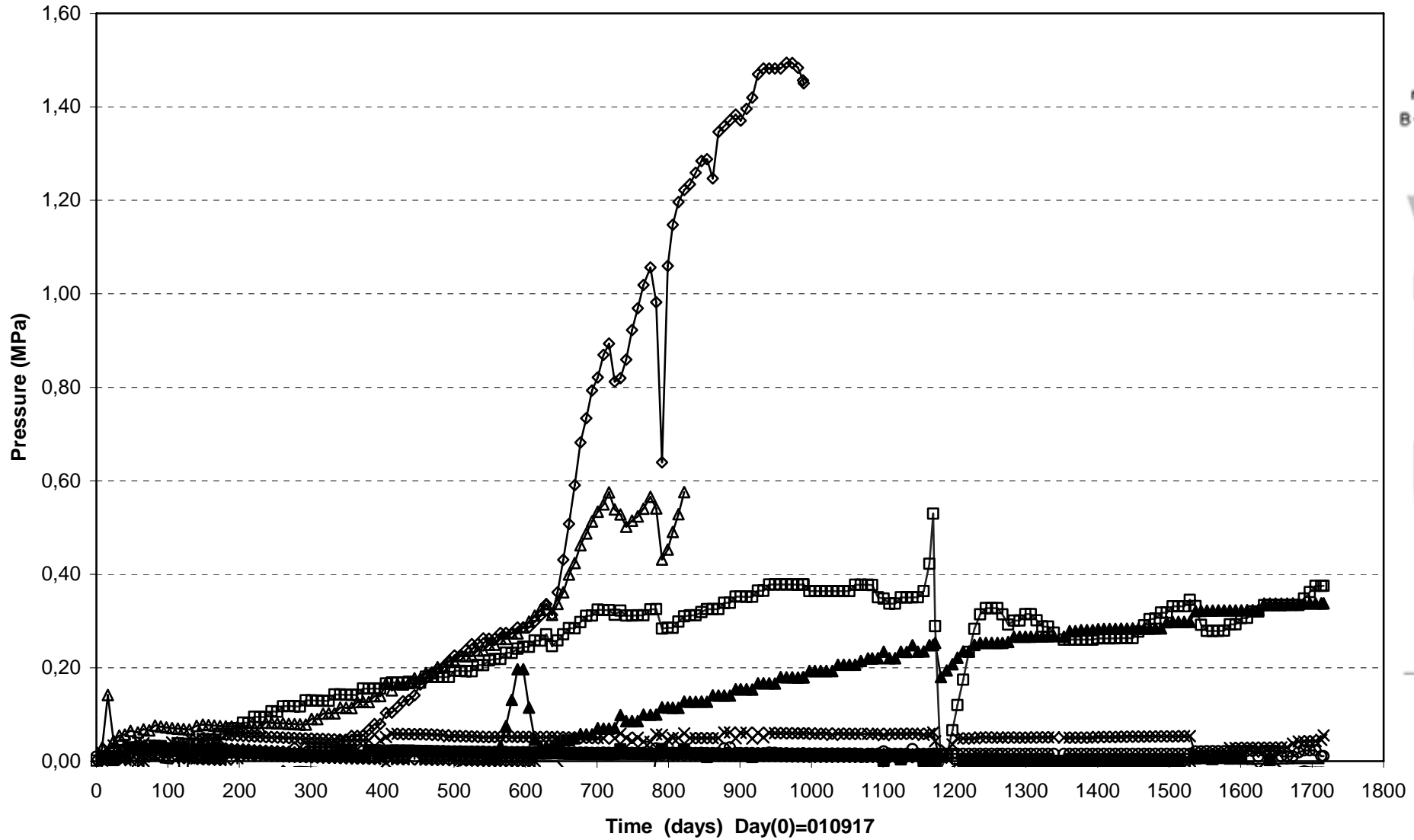
● WBU10027(5.308\80°\0.585) ▲ WBU10028(5.308\80°\0.685) ■ WBU10029(5.308\80°\0.785) ○ WBU10031(5.308\170°\0.785)



Prototyp\Hole 1\Cyl.3 (010917-060601)  
 Relative humidity - Rotronic

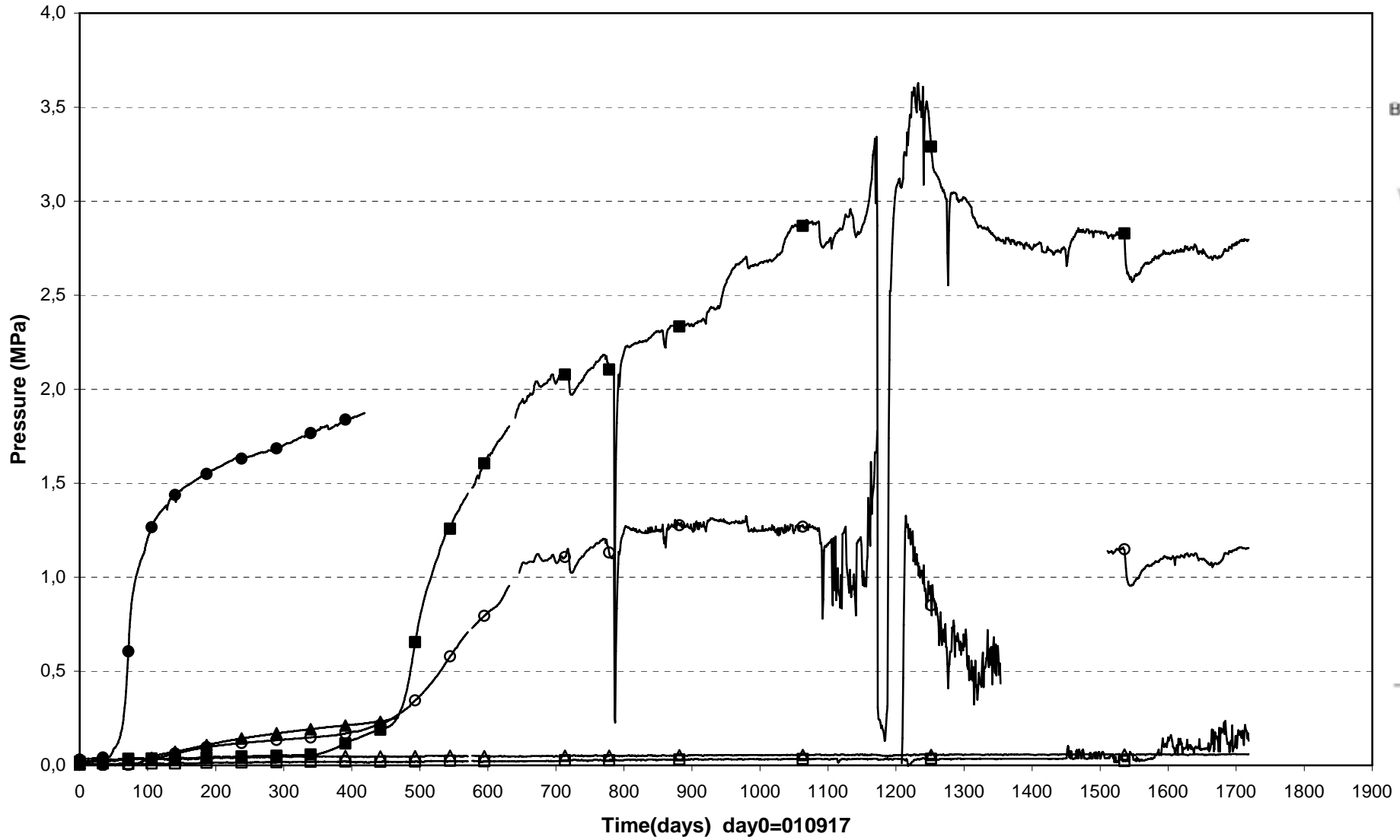


Prototype\Hole 1 (010917-060601)  
 Pore pressure - Geokon

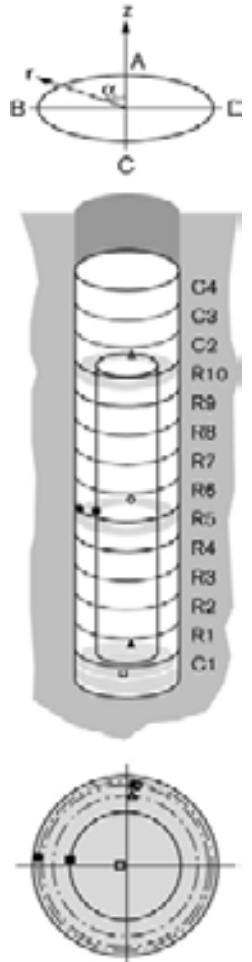


✕ UBU10002(0.254\90°\0.100)	▲ UBU10003(0.344\355°\0.585)	◇ UBU10005(2.780\355°\0.585)	△ UBU10009(2.780\175°\0.535)
◻ UBU10010(2.780\175°\0.825)	■ UBU10012(5.308\355°\0.785)	○ UBU10013(6.317\90°\0.050)	* UBU10014(6.916\90°\0.050)

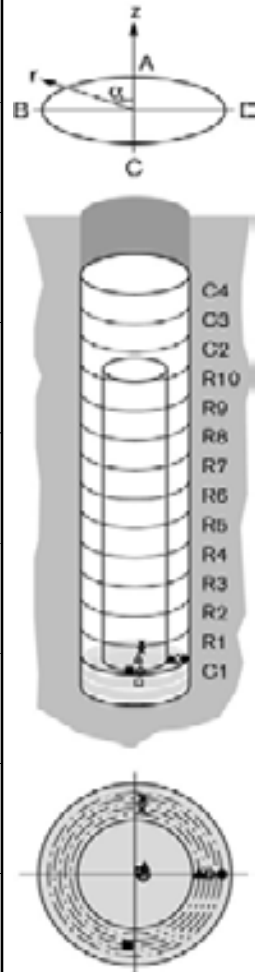
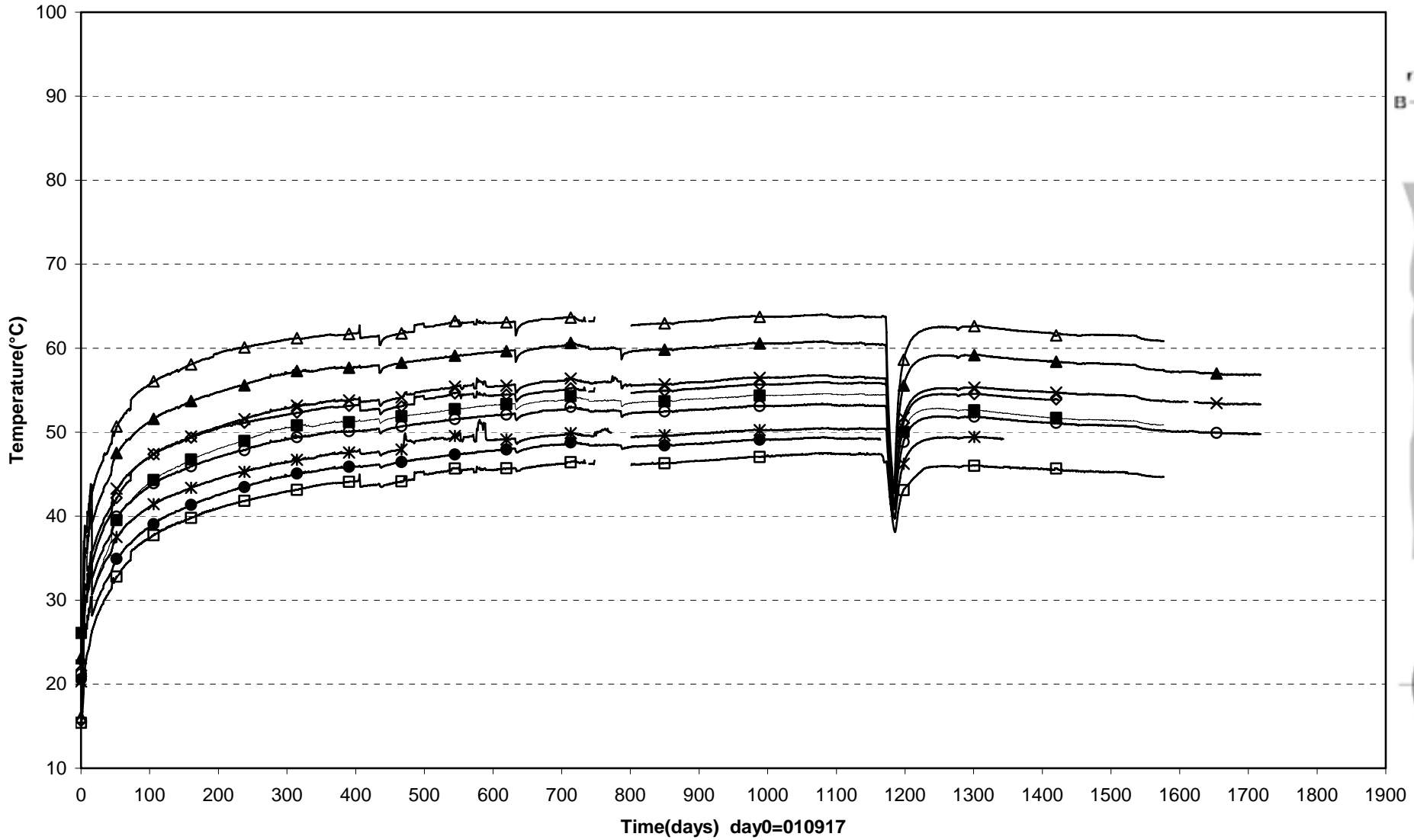
Prototype\ Hole 1 (010917-060601)  
 Pore pressure - Kulite



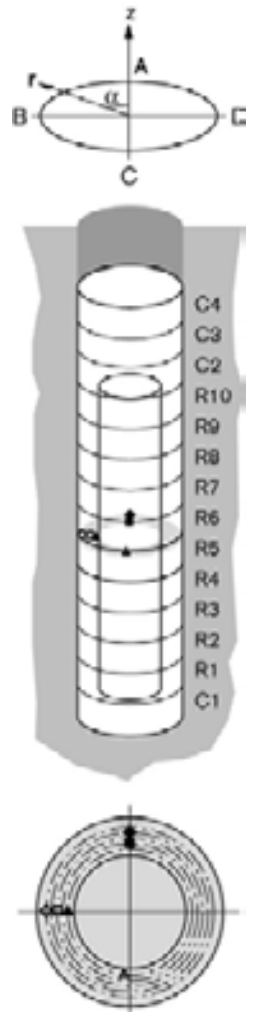
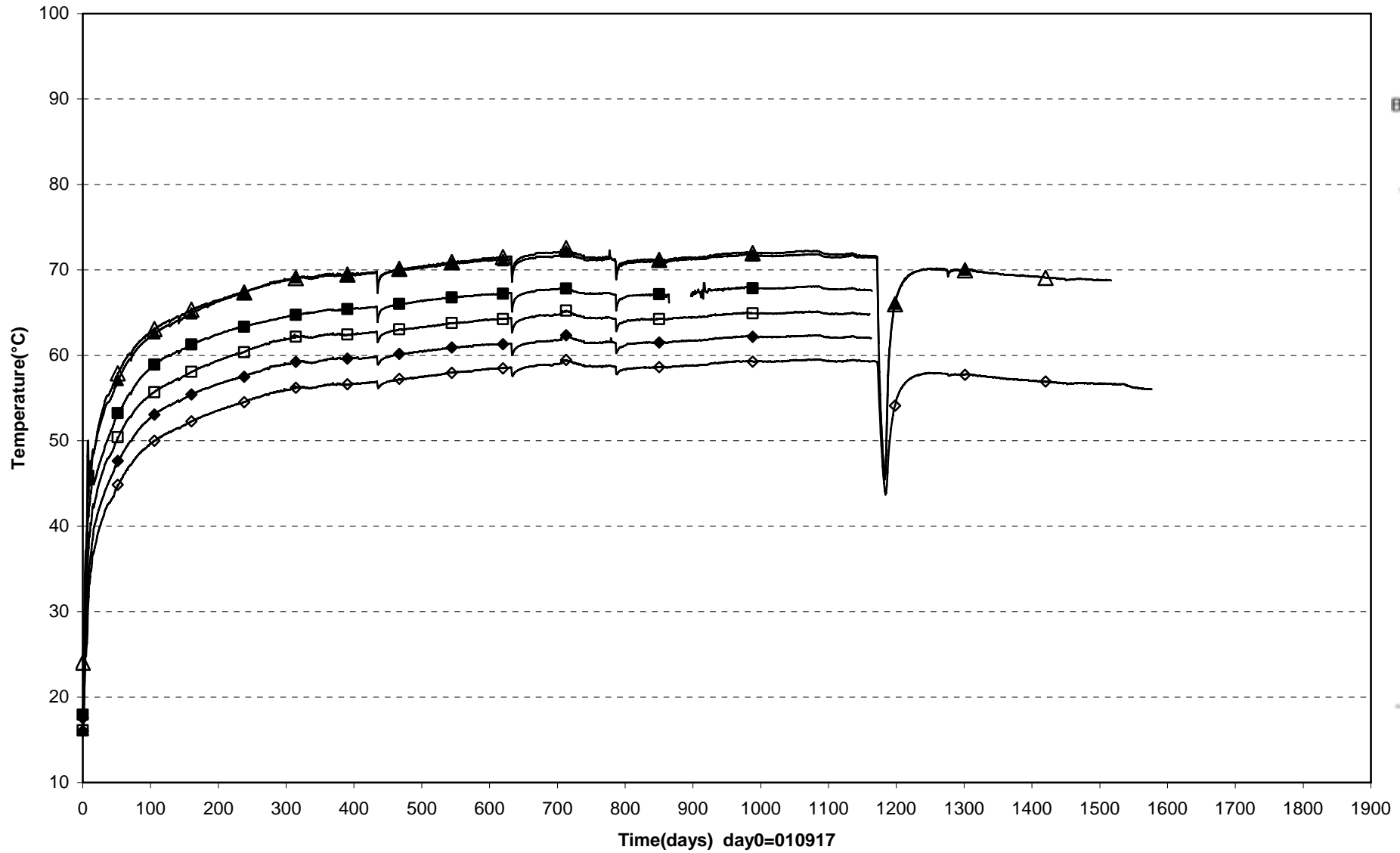
□ UBU10001(0.054\90°\0.050)	▲ UBU10004(0.344\355°\0.785)	○ UBU10006(2.870\355°\0.785)
■ UBU10007(2.870\85°\0.535\In the slot)	● UBU10008(2.870\85°\0.825\In the slot)	△ UBU100011(5.398\355°\0.585)



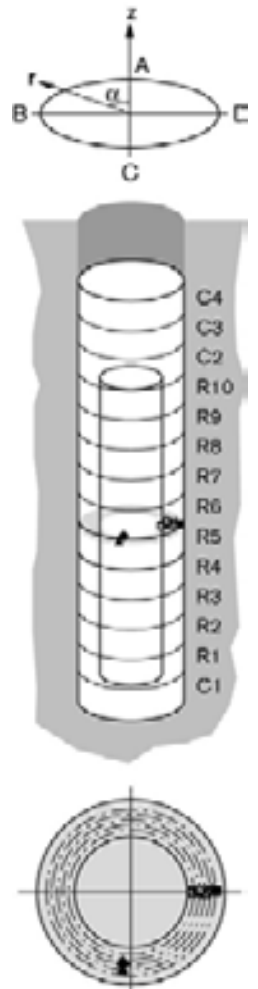
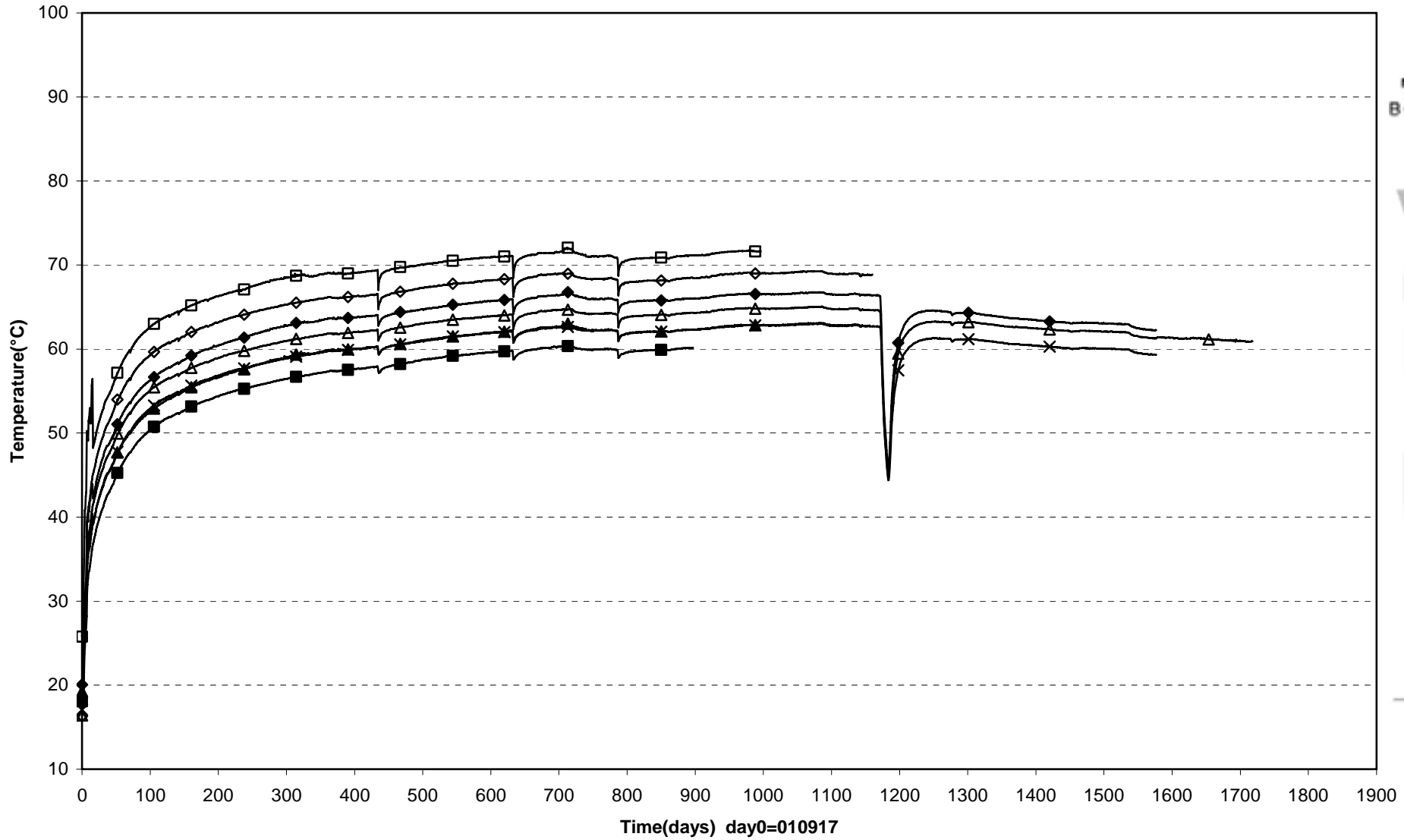
Prototype\Hole 1\Cyl.1 (010917-060601)  
 Temperature - Pentronic



Prototype\Hole 1 \Ring5 (010917-060601)  
 Temperature - Pentronic

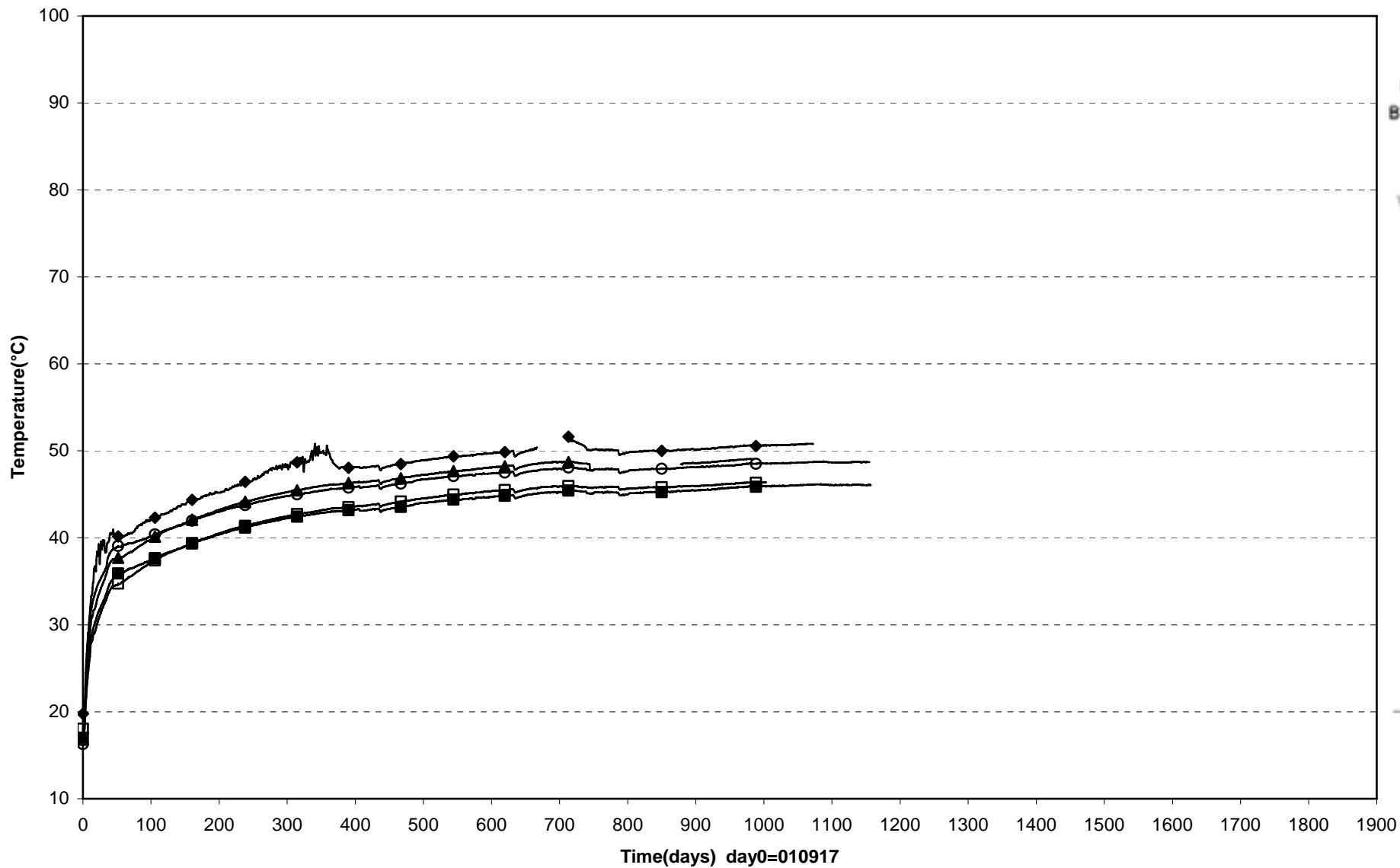


Prototype\Hole 1 \Ring5 (010917-060601)  
 Temperature - Pentronic



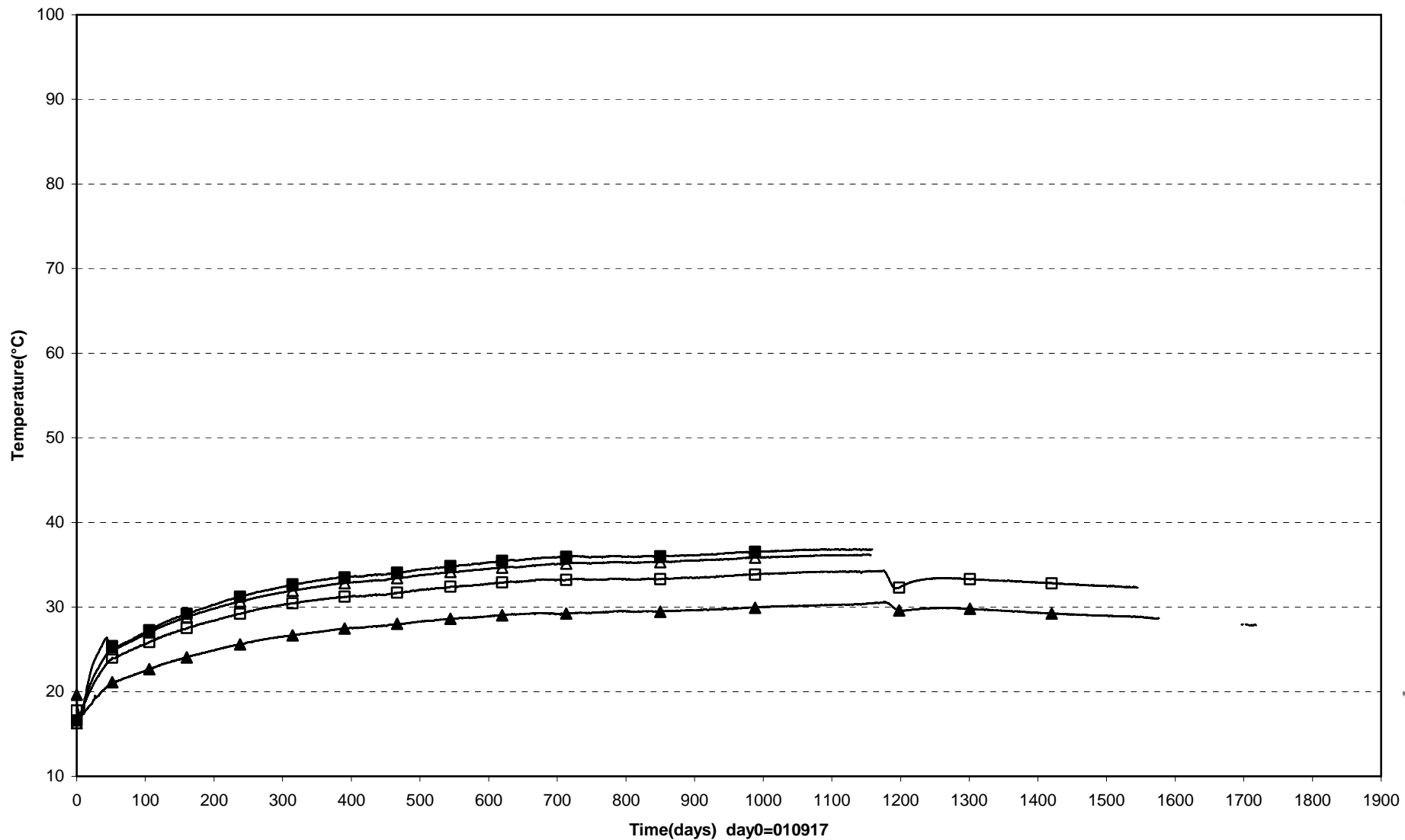


Prototype\Hole 1 \Ring10 (010917-060601)  
 Temperature - Pentronic

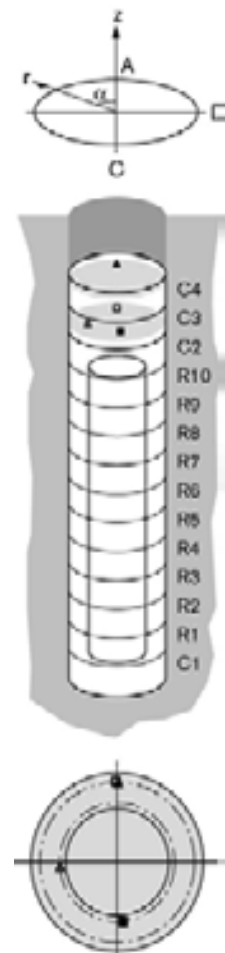


○ TBU10024(5.508\0°\0.635) ■ TBU10025(5.508\0°\0.735) ◆ TBU10026(5.508\270°\0.585) ▲ TBU10027(5.508\270°\0.685) □ TBU10028(5.508\270°\0.785)

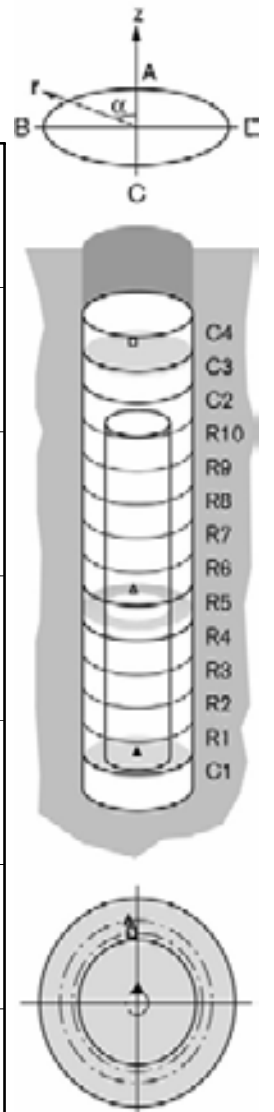
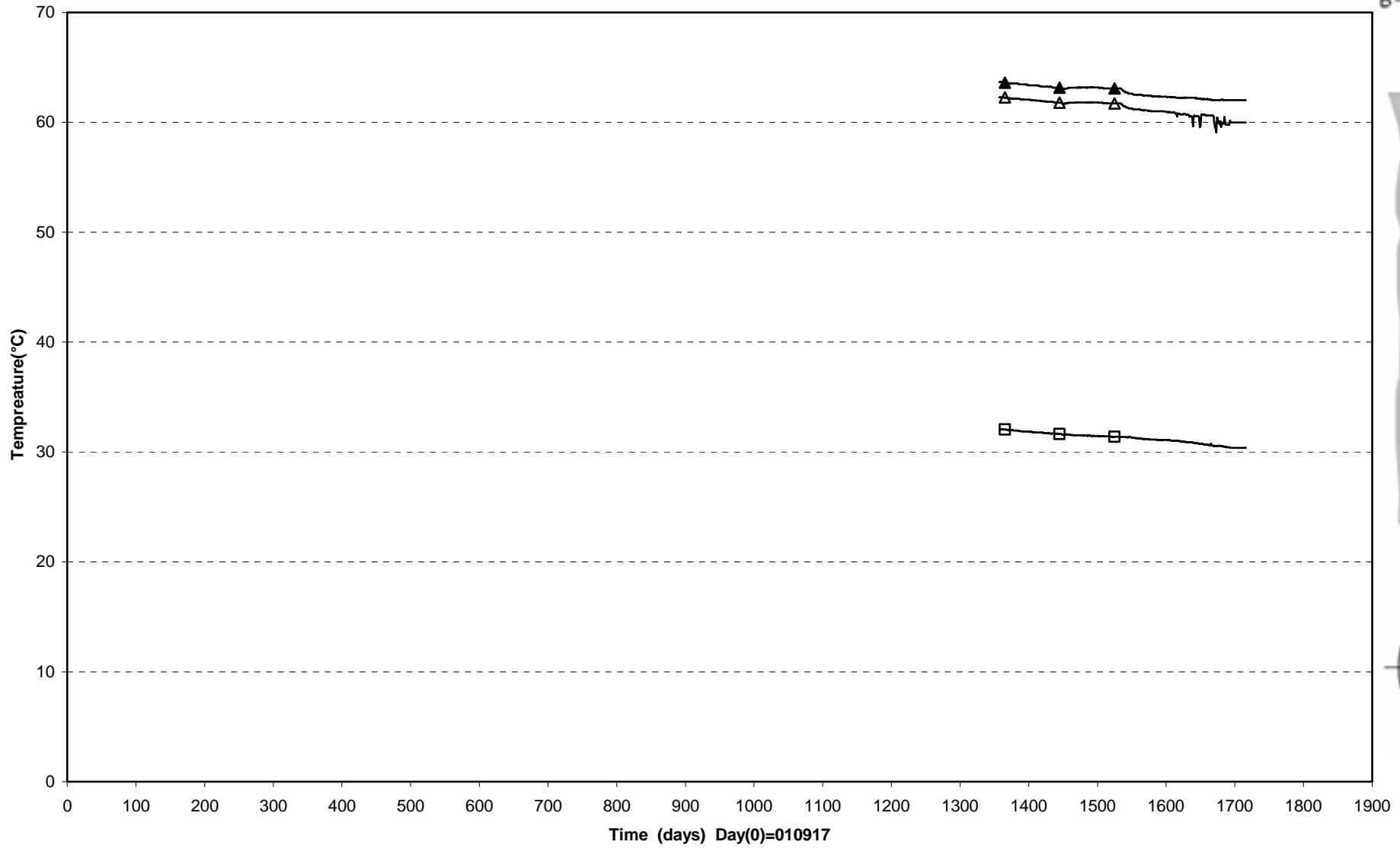
Prototype\Hole 1 \Cyl.3 and Cyl.4 (010917-060601)  
 Temperature - Pentronic



□ TBU10029(6.317\0°\0.785)    △ TBU10030(6.317\95°\0.585)    ■ TBU10031(6.317\185°\0.585)    ▲ TBU10032(7.026\0°\0.785)

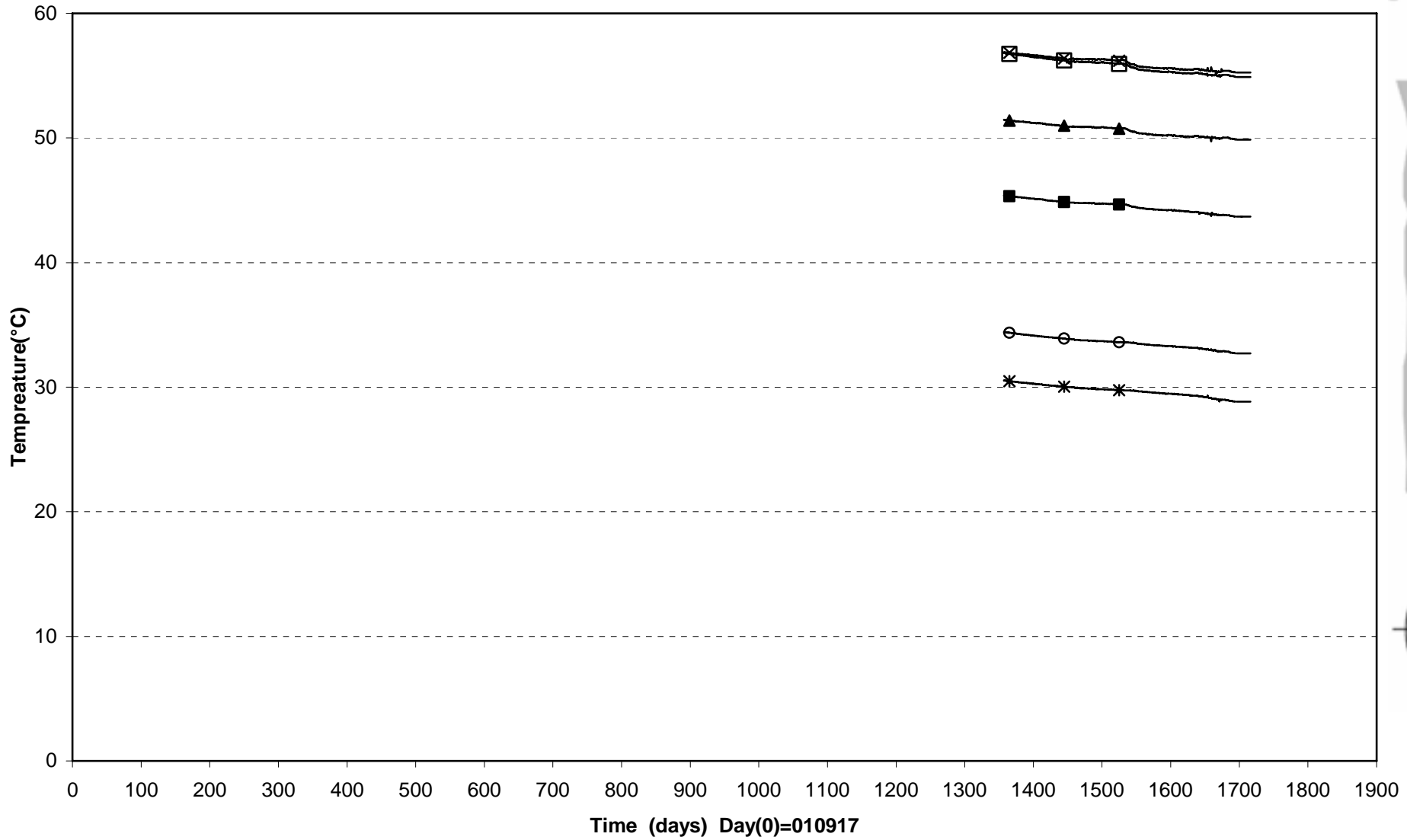


Prototype\Hole 1\Cyl.1 (010917-060601)  
 Temperature - Geokon

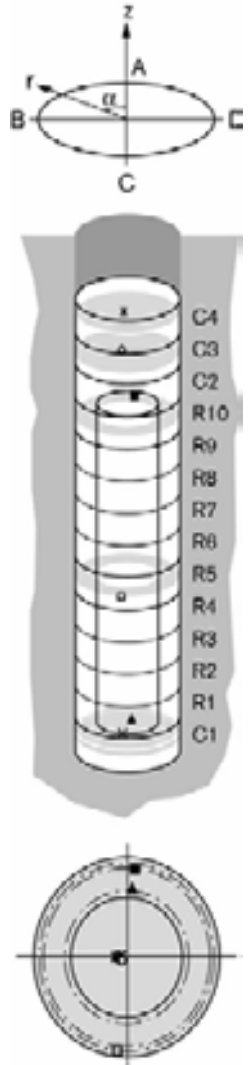


▲ PBU10002(0.504\0°\0.100)    Δ PBU10011(2.780\5°\0.685)    □ PBU10026(6.567\5°\0.585)

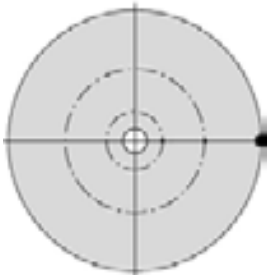
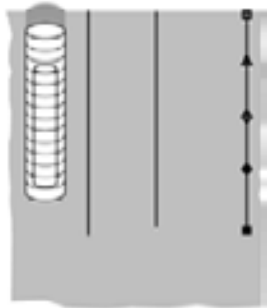
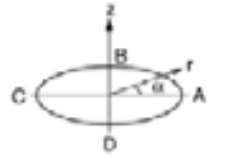
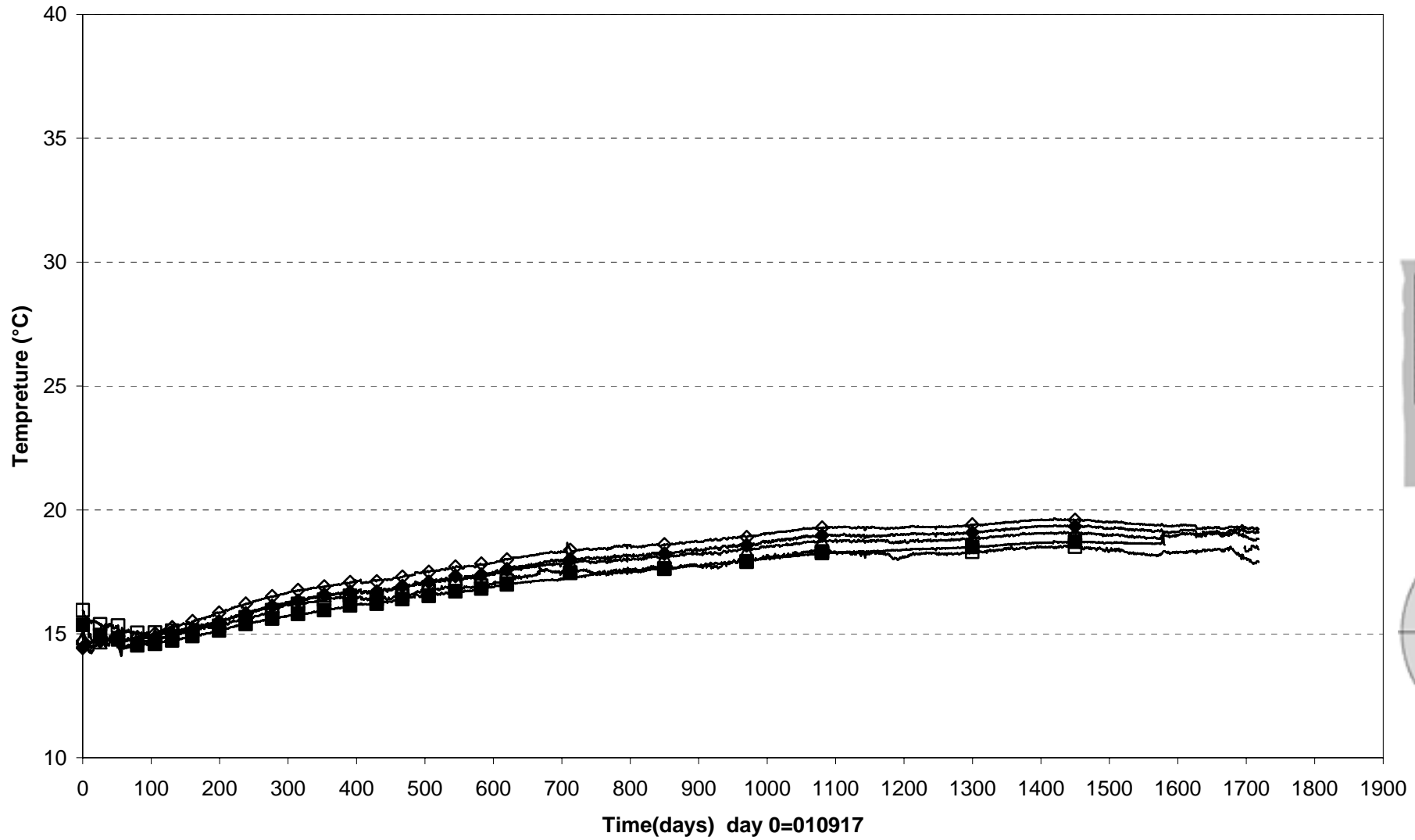
Prototype\Hole 1 (010917-060601)  
 Temperture - Geokon



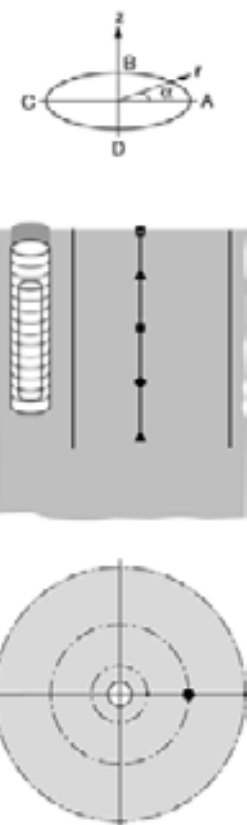
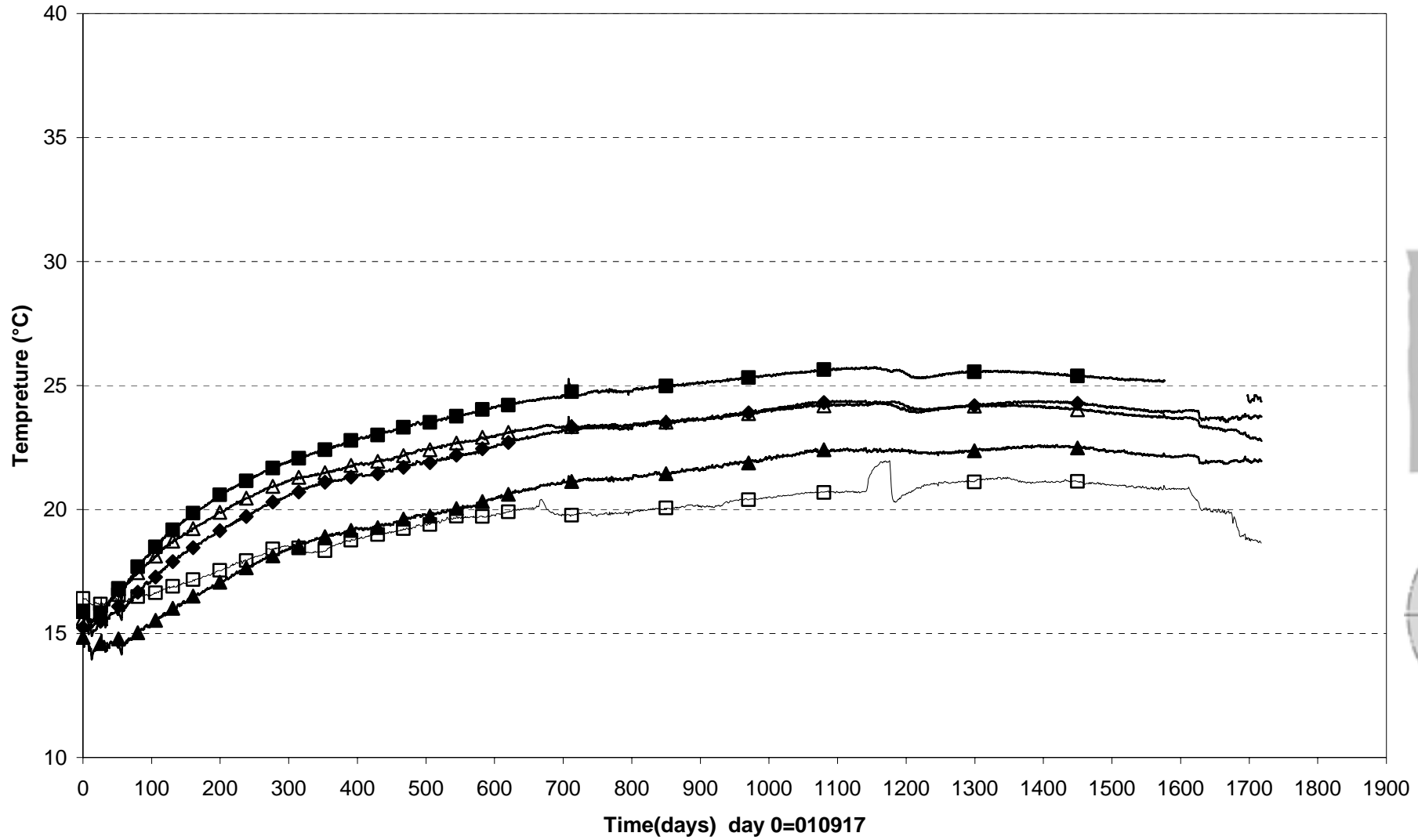
× UBU10002(0.254\90°\0.100)    ▲ UBU10003(0.344\355°\0.585)    □ UBU10010(2.780\175°\0.825)    ■ UBU10012(5.308\355°\0.785)  
 ○ UBU10013(6.317\90°\0.050)    ✱ UBU10014(6.916\90°\0.050)



Prototype\Rock\Hole 1 (010917-060601)  
 Temperature - Pentronic

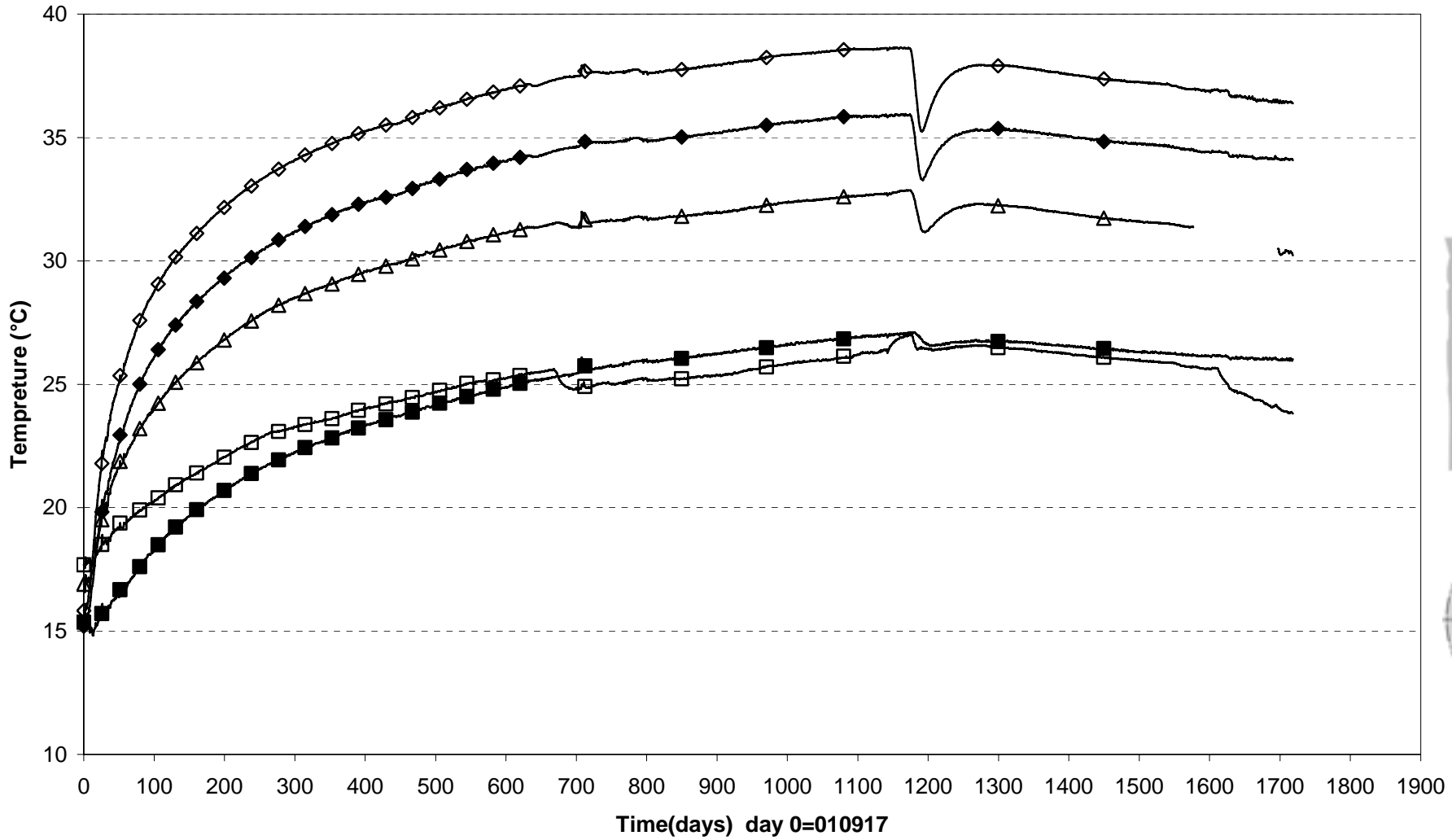


Prototype\Rock\Hole 1 (010917-060601)  
 Temperature - Pentronic



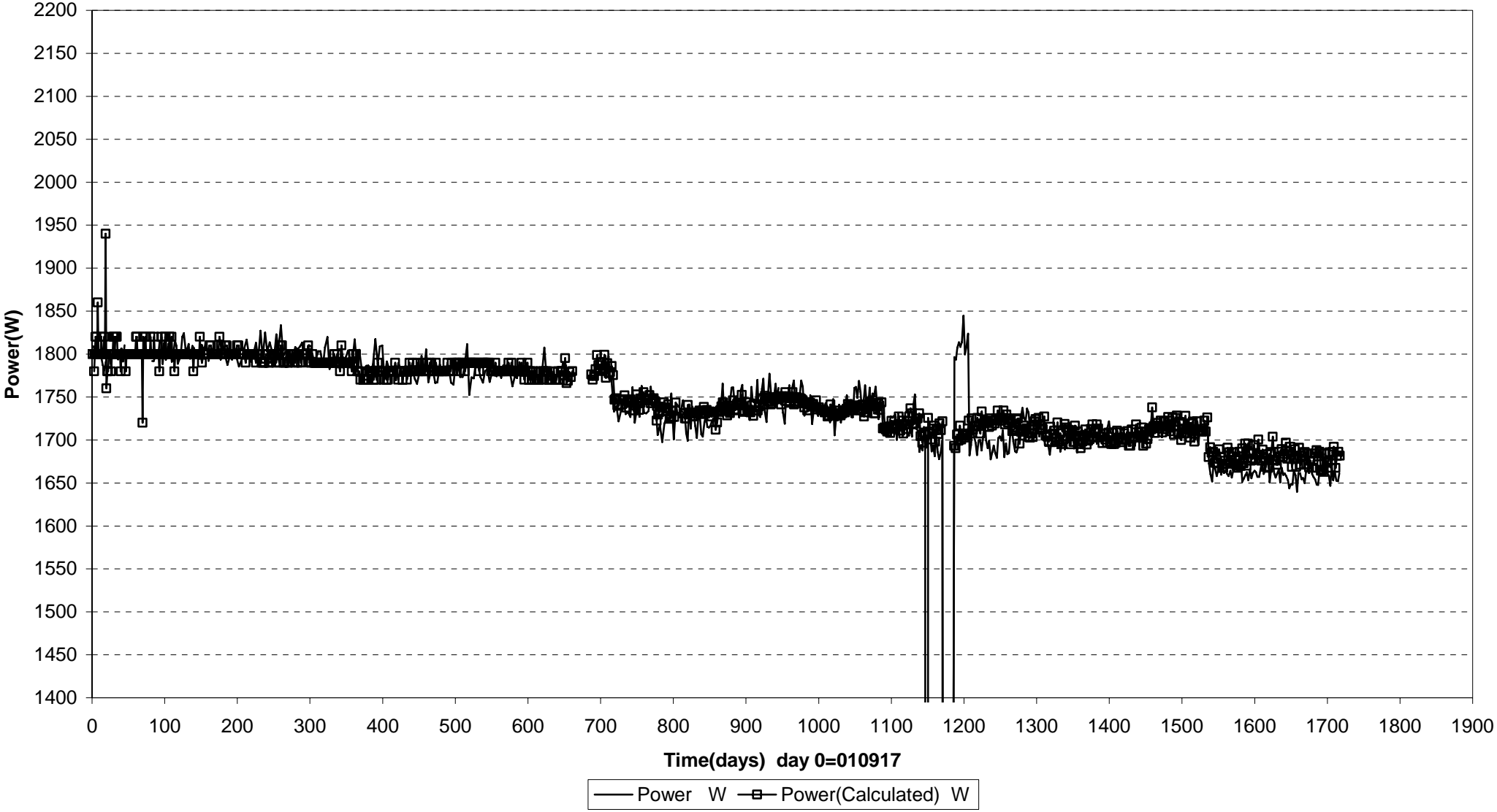
□ TROA650(7.921\360°\4.966)    Δ TROA640(5.921\360°\4.988)    ■ TROA630(3.521\360°\4.978)    ◆ TROA620(1.121\360°\4.968)    ▲ TROA610(-1.479\360°\4.956)

Prototype\Rock\Hole 1 (010917-060601)  
Temperature - Pentronic



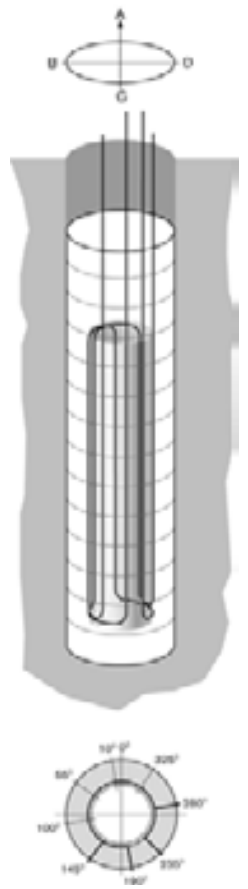
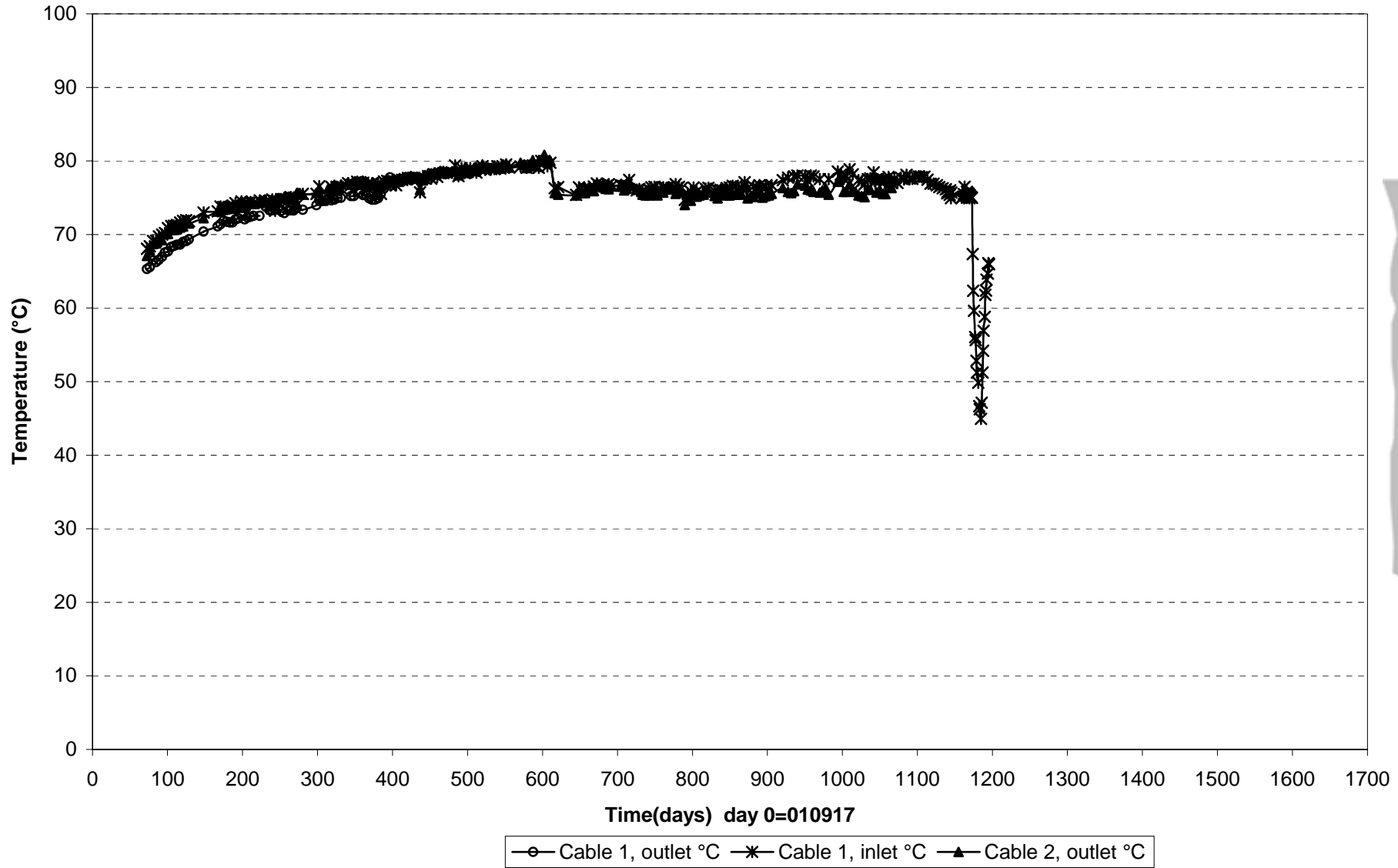
□ TROA1050(7.662\359°\2.020)    △ TROA1040(5.662\359°\2.028)    ◇ TROA1030(3.262\359°\2.038)    ◆ TROA1020(0.862\359°\2.048)    ■ TROA1010(-1.838\359°\2.059)

Prototype\ Hole 1 (010917-060601)  
Canister power

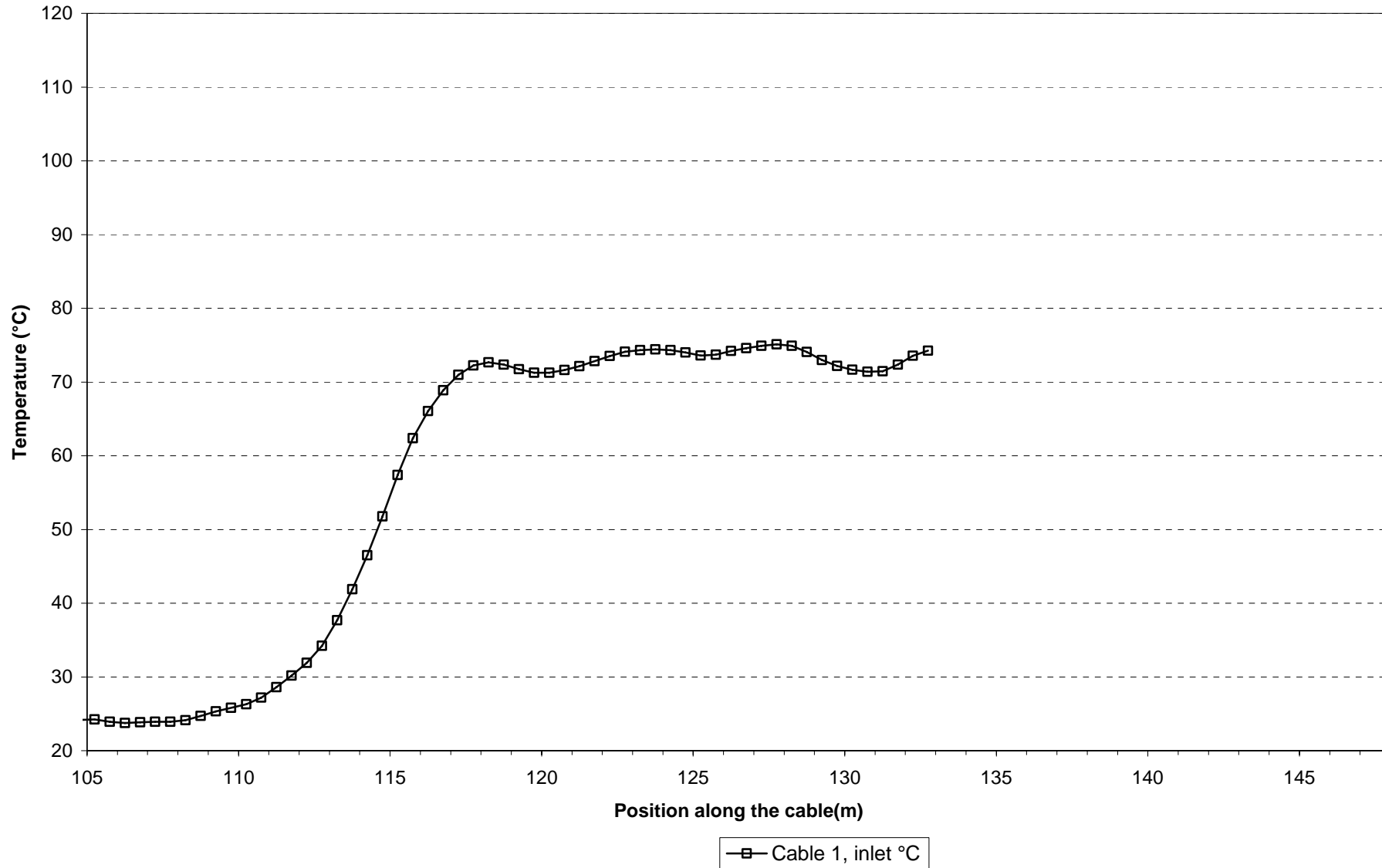




Prototype\ Hole 1 \Canister (010917-060601)  
 Max. temperature on the canister surface - Optical fiber cables



Prototype\ Hole 1 \ Canister (041201)  
Temperature profile on the canister surface - Optical fiber cables

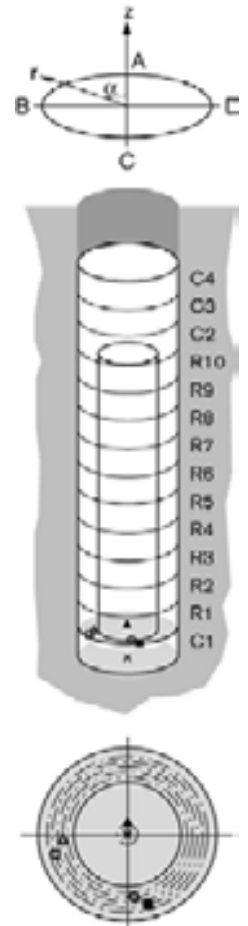
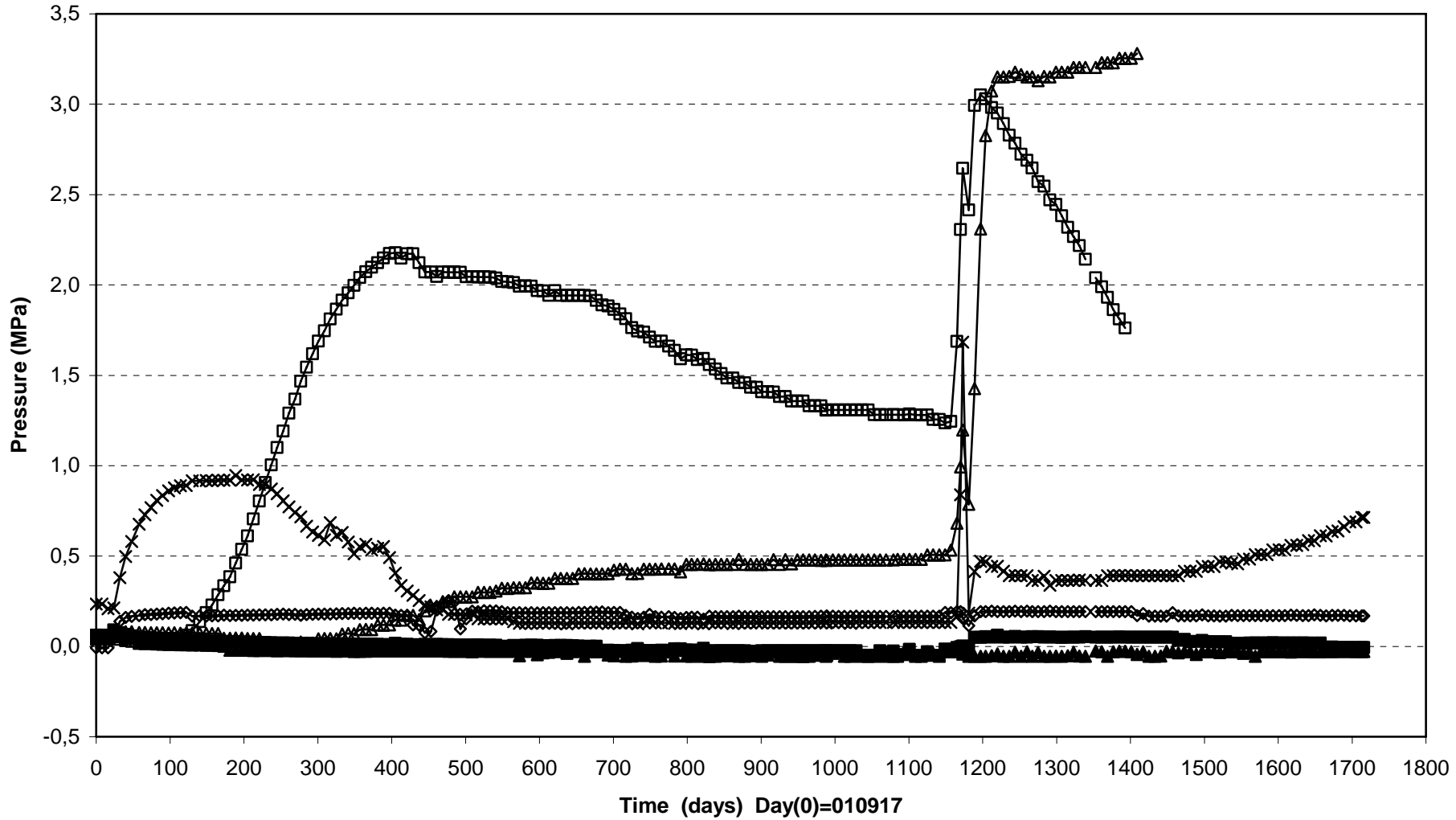


## **Appendix 2**

**Dep. hole 3**

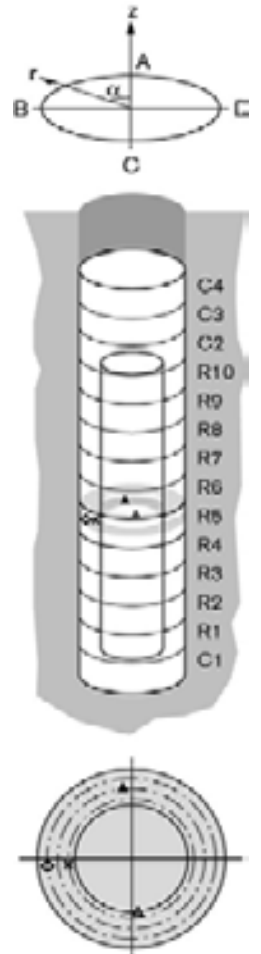
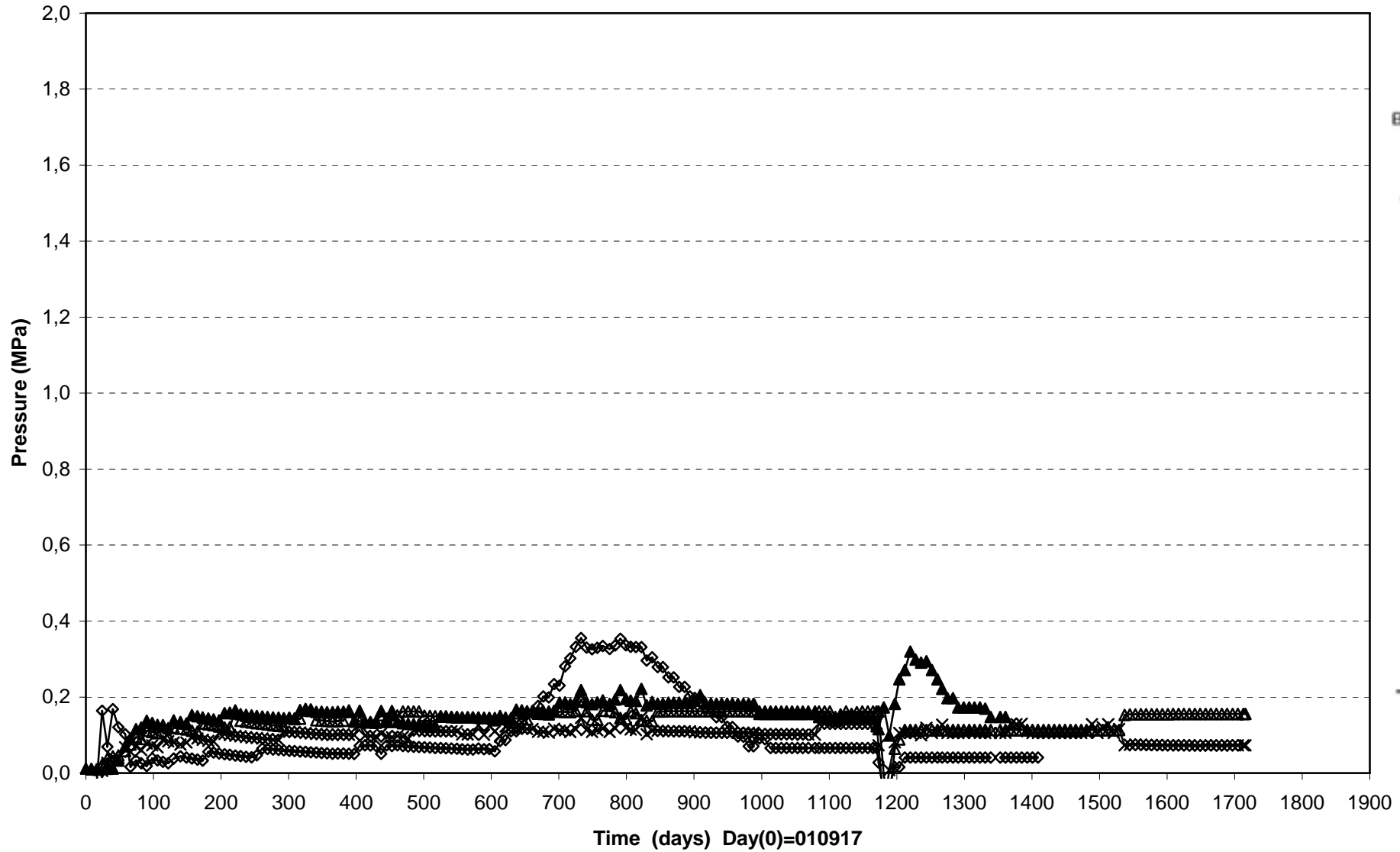


Prototype\Hole 3\Cyl.1 (010917-060601)  
 Total pressure - Geokon



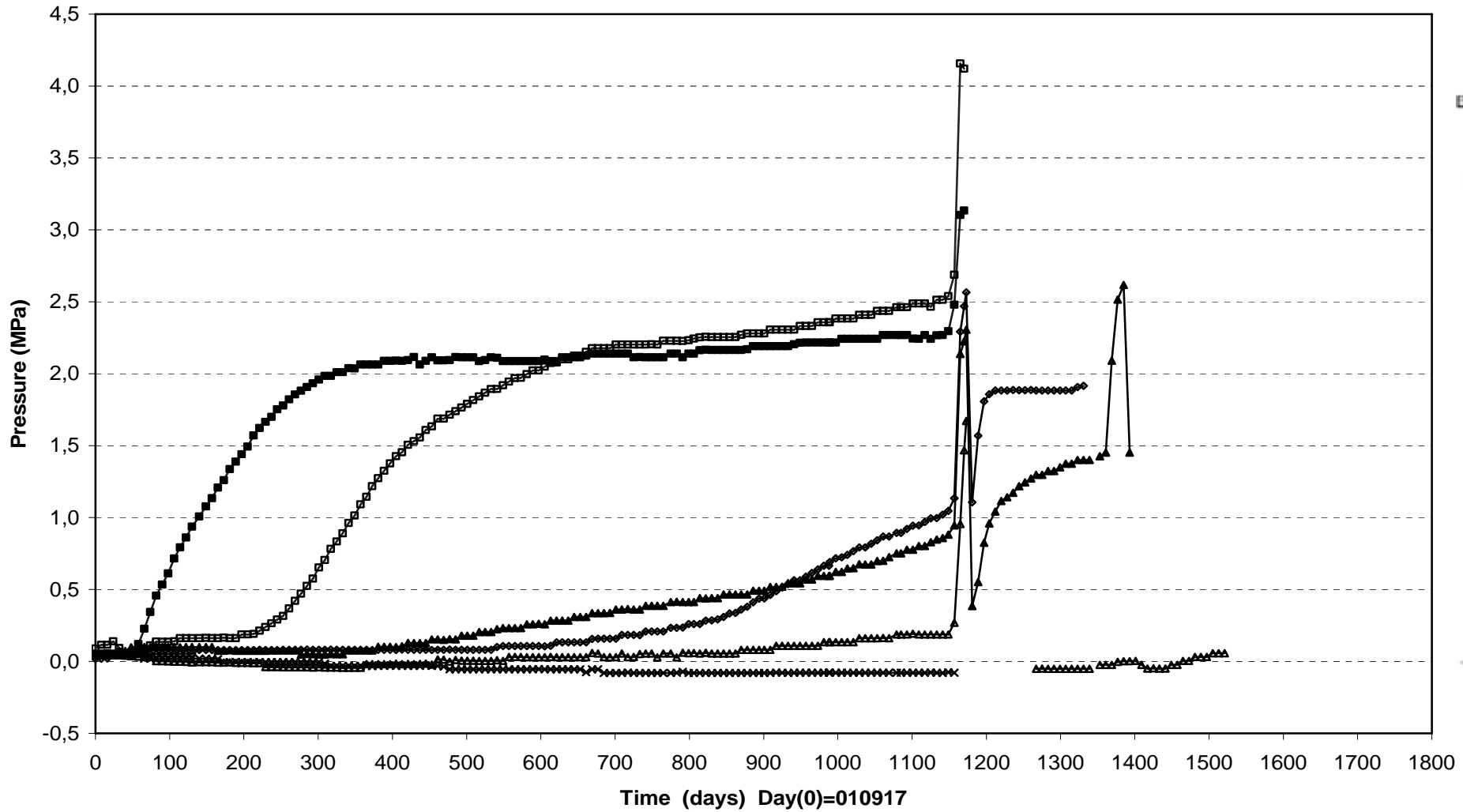
- |                               |                                |                                |
|-------------------------------|--------------------------------|--------------------------------|
| —x— PBU30001(0\0°\0)          | —▲— PBU30002(0.495\0°\0.100)   | —◇— PBU30008(0.495\185°\0.635) |
| —△— PBU30006(0.495\95°\0.635) | —□— PBU30007(0.495\105°\0.735) | —■— PBU30009(0.495\195°\0.735) |

Prototype\Hole 3 \Ring5 (010917-060601)  
 Total pressure - Geokon

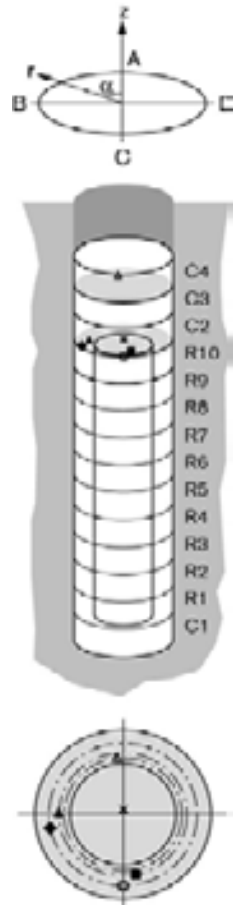


—x— PBU30013(2.771\95°\0.585) —▲— PBU30011(2.771\5°\0.685) —◇— PBU30014(2.771\95°\0.785) —△— PBU30015(3.021\185°\0.535)

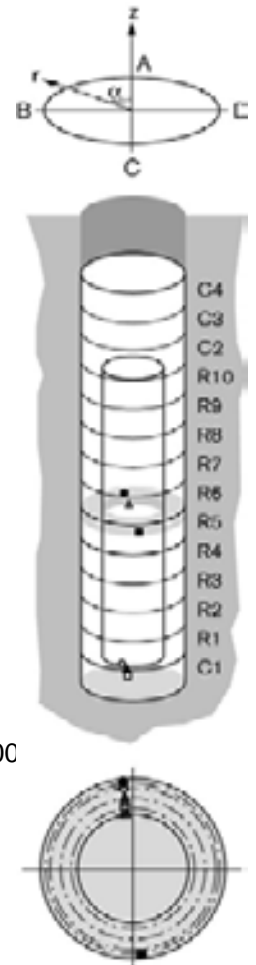
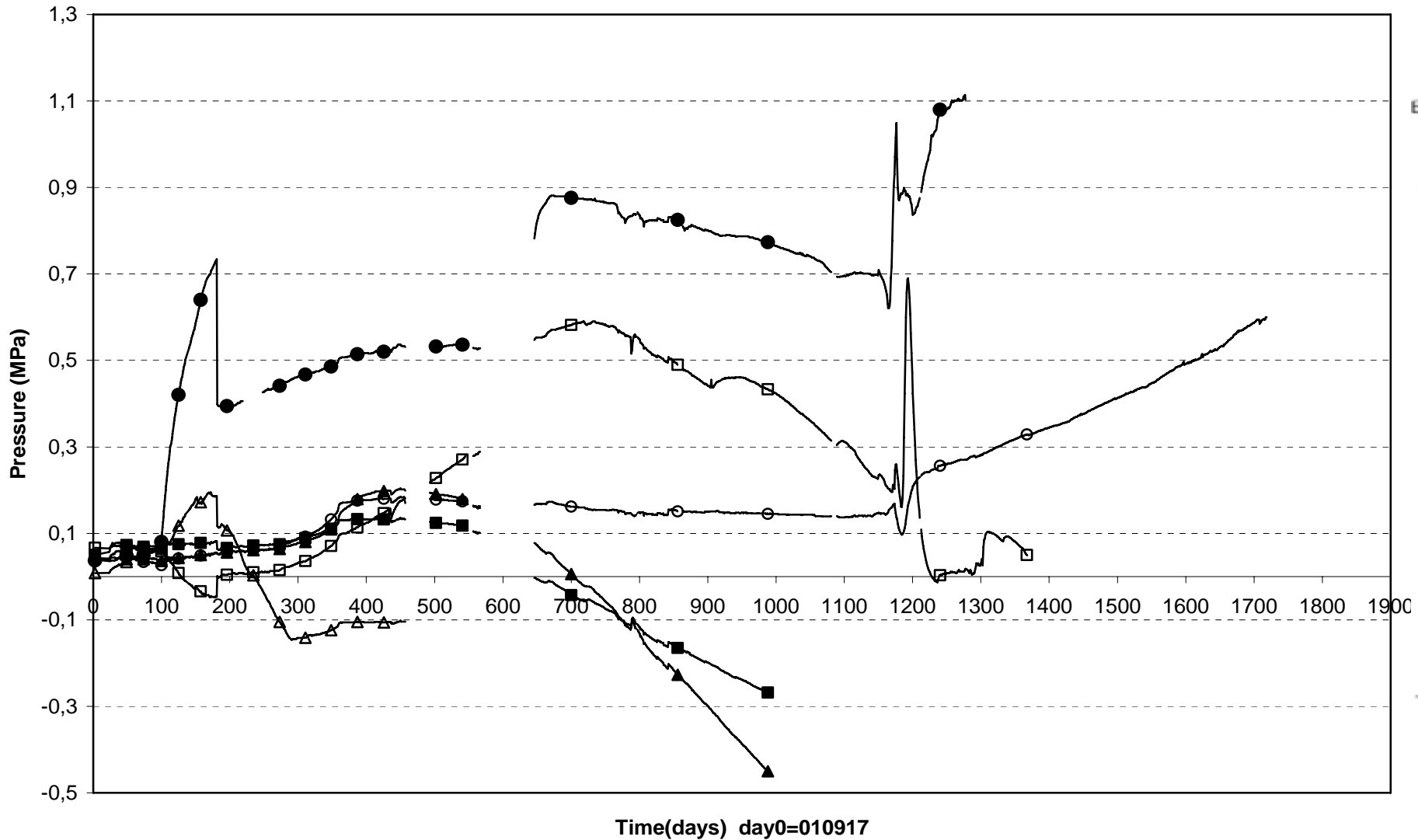
Prototype\Hole 3\Ring10 and Cyl.3 (010917-060601)  
 Total pressure - Geokon



- x— PBU30017(5.556\0°\0.050)
- ▲— PBU30021(5.556\90°\0.635)
- ◆— PBU30022(5.556\100°\0.735)
- △— PBU30026(6.654\5°\0.585)
- PBU30023(5.556\190°\0.735)
- PBU30024(5.556\190°\0.635)

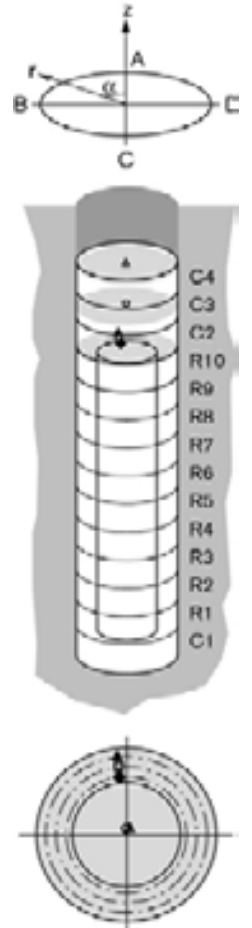
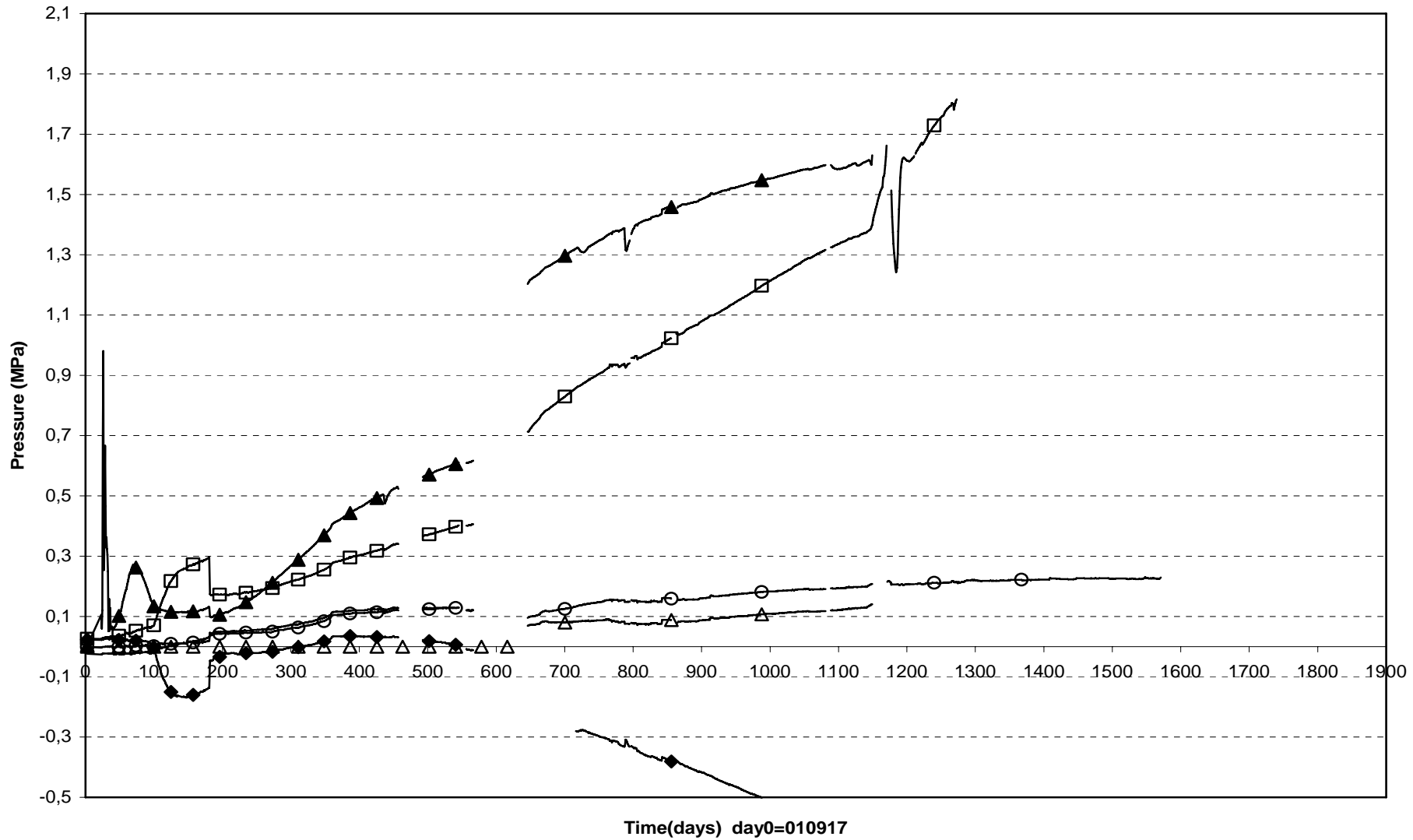


Prototype\Hole 3 \Cyl.1 and Ring5 (010917-060601)  
 Total pressure - Kulite



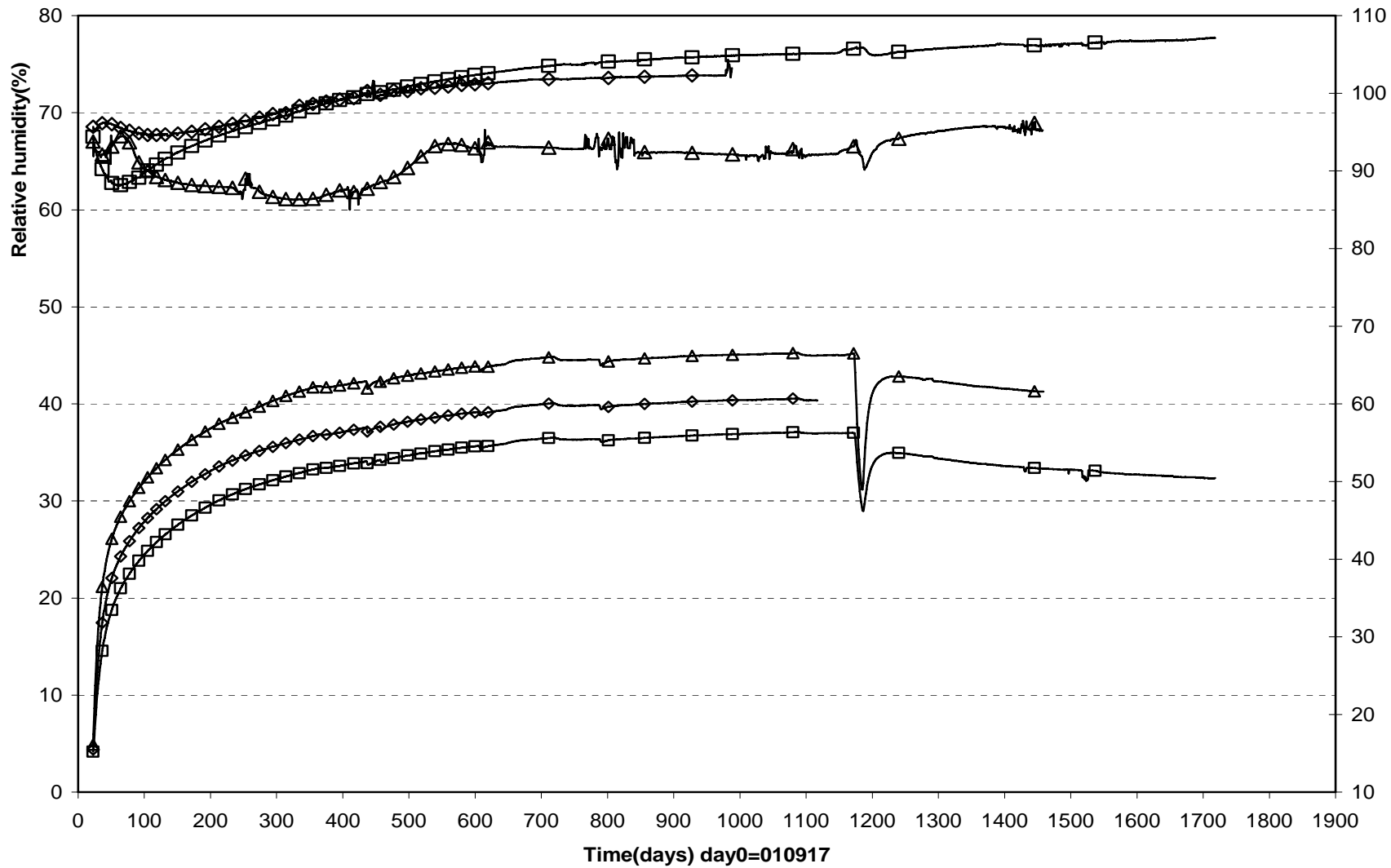


Prototype\Hole 3\Ring10 and Cyl.3-4 (010917-060601)  
 Total pressure - Kulite

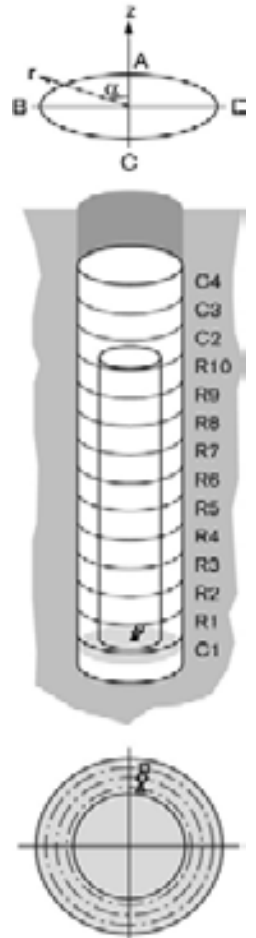


◆ PBU30018(Ring10\5°\0.585) □ PBU30019(Ring10\5°\0.685) ▲ PBU30020(Ring10\5°\0.785) ○ PBU30025(Cyl.3\0°\0.050) △ PBU30027(Cyl.4\0°\0.050)

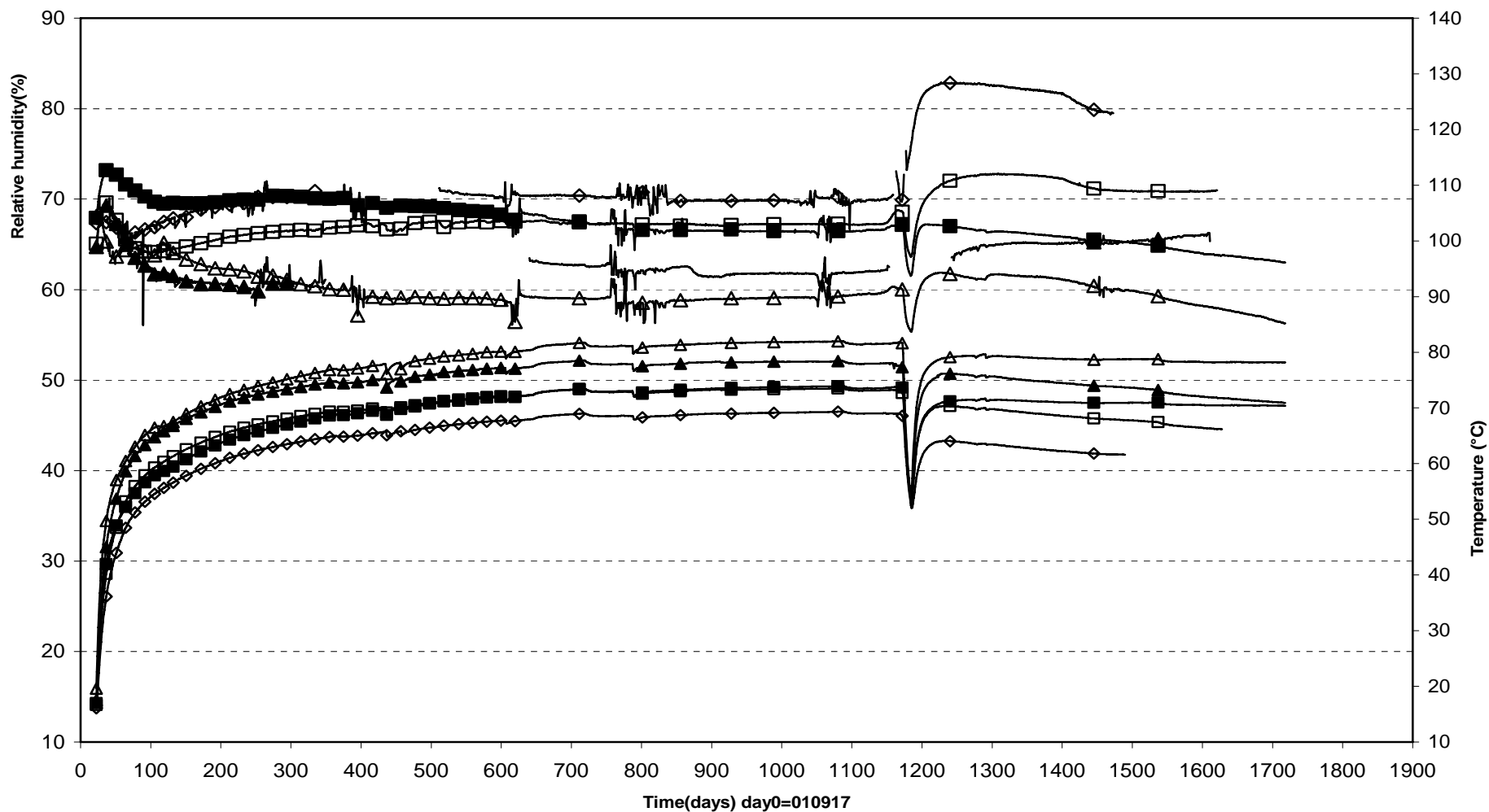
Prototype\Hole 3\Cyl.1 (010917-060601)  
Relative humidity - Vaisala



□ WBU30004(0.335\350°\0.785)    ◇ WBU30005(0.335\350°\0.685)    △ WBU30006(0.335\350°\0.585)

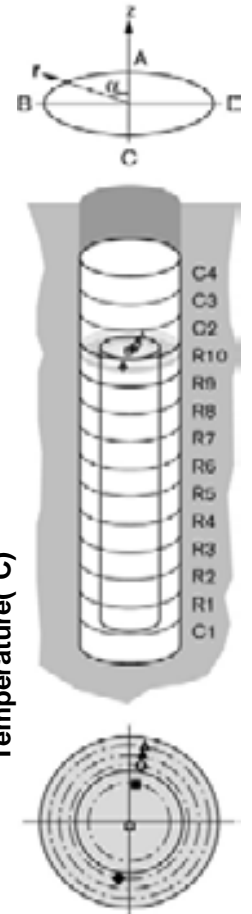
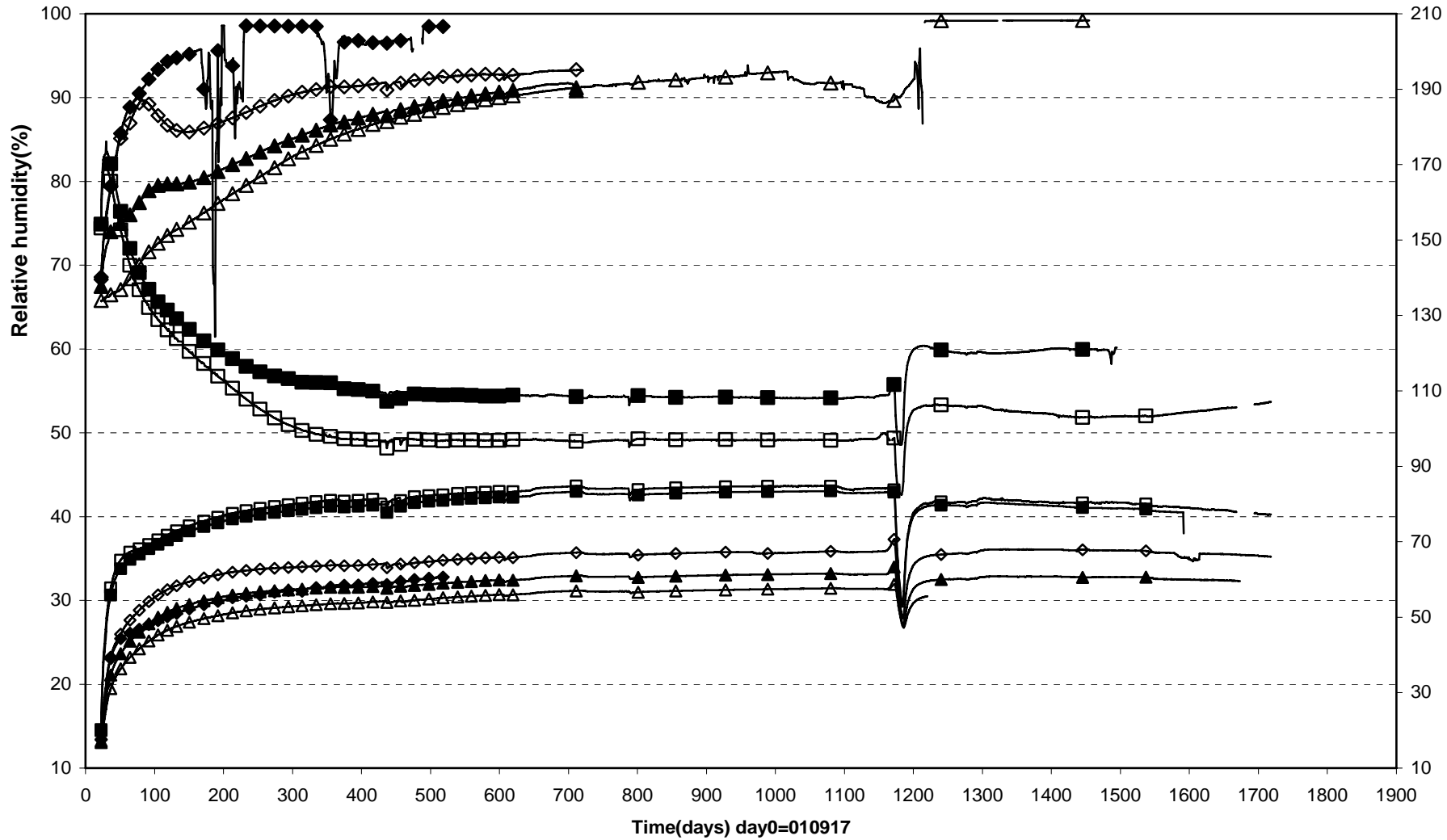


Prototype\Hole 3\Ring 5 (010917-060601)  
Relative humidity - Vaisala



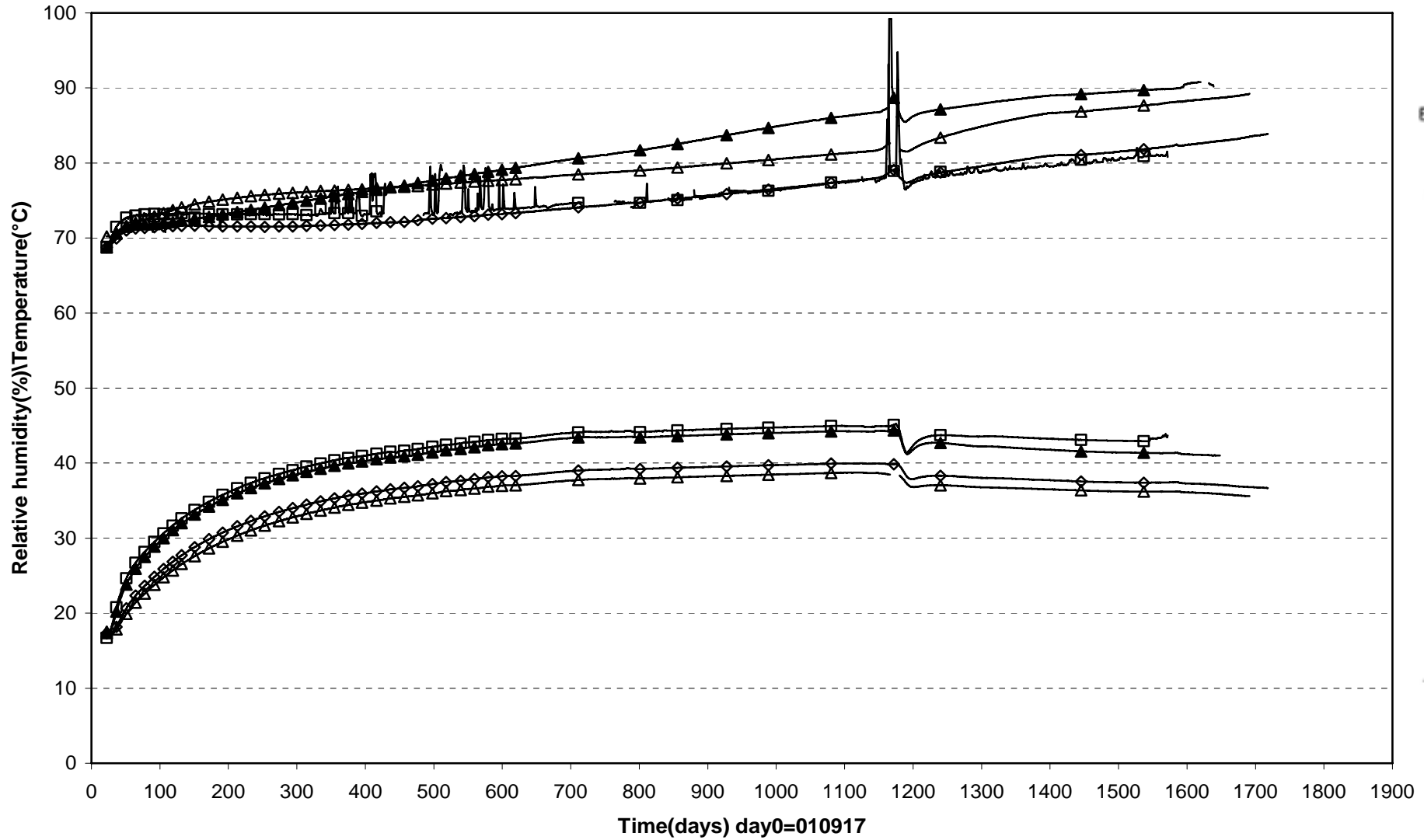
- |  |                              |                              |
|--|------------------------------|------------------------------|
| ▲ WBU30013(2.840\350°\0.585)             | □ WBU30014(2.840\350°\0.685) | ◇ WBU30015(2.840\350°\0.785) |
| △ WBU30019(2.840\180°\0.535\In the slot) | ■ WBU30020(2.840\180°\0.685) |                              |

Prototype\Hole 3\Ring 10 (010917-060601)  
Relative humidity - Vaisala

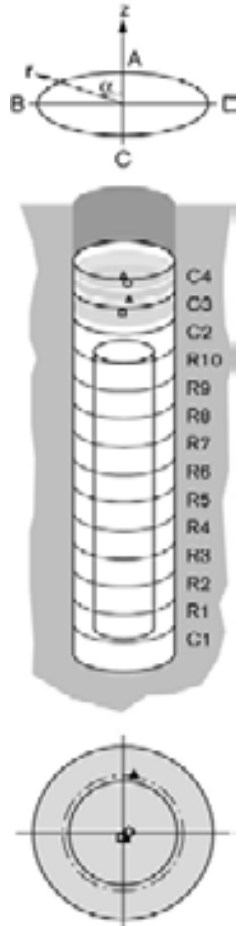


□ WBU30022(5.416\180°\0.050)    ■ WBU30023(5.396\352°\0.262)    ◇ WBU30024(5.396\350°\0.585)    △ WBU30025(5.396\350°\0.785)  
▲ WBU30026(5.396\350°\0.685)    ◆ WBU30030(5.396\170°\0.585)

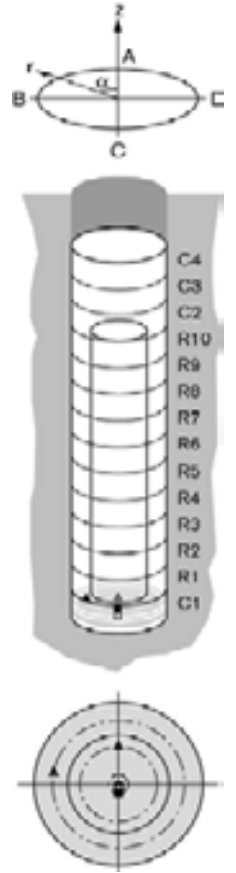
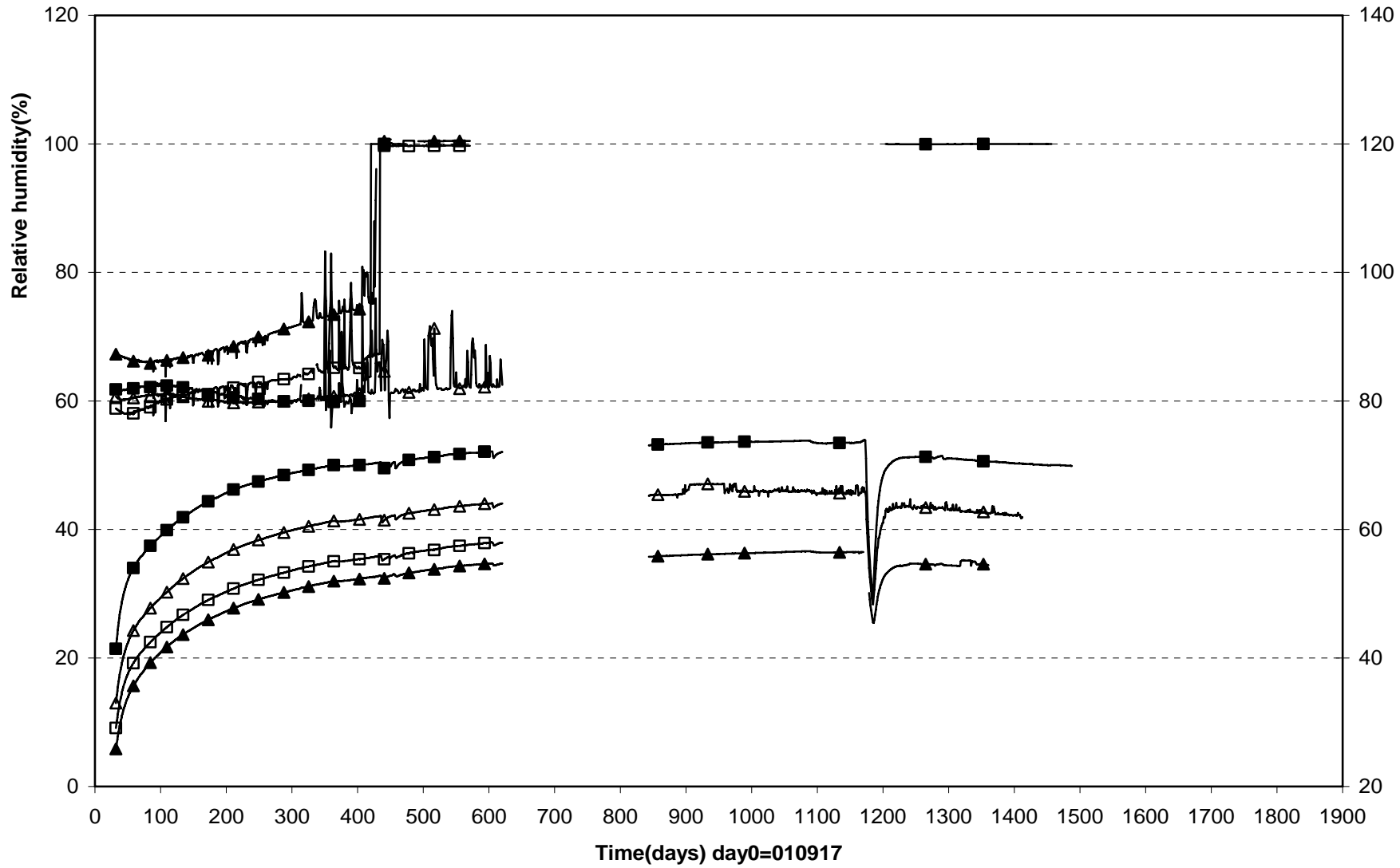
Prototype\Hole 3\Cyl.3 and Cyl.4 (010917-060601)  
 Relative humidity - Vaisala



□ WBU30032(6.314\180°\0.050) ▲ WBU30033(6.314\350°\0.585) △ WBU30036(6.680\180°\0.050) ◇ WBU30037(6.840\270°\0.050)

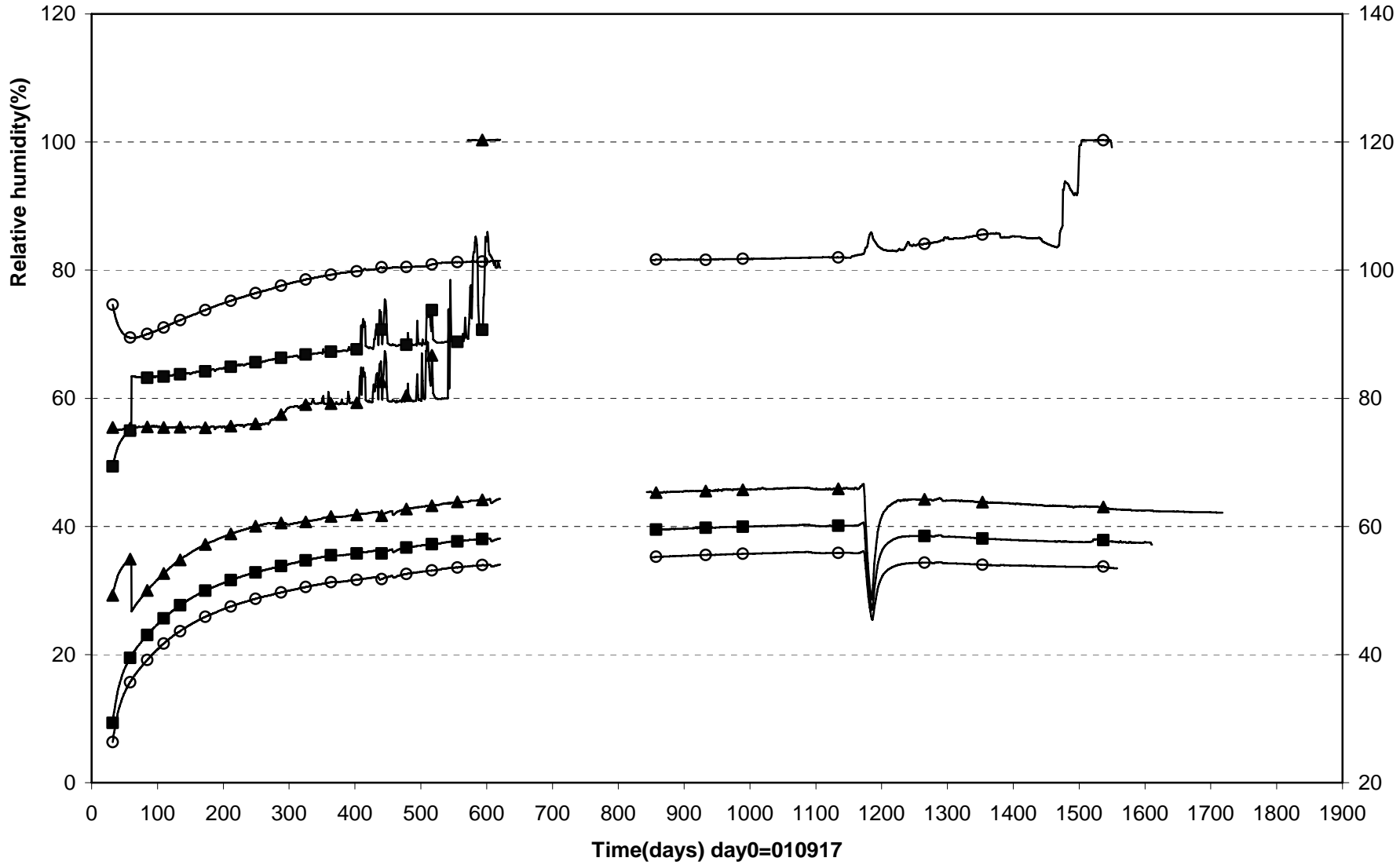


Prototype\Hole 3\Cyl.1 (010917-060601)  
 Relative humidity - Rotronic

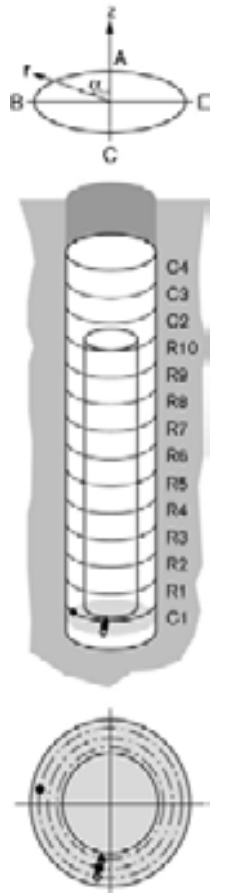


□ WBU30001(0.045\180°\0.050)    △ WBU30002(0.215\0°\0.400)    ■ WBU30003(0.245\180°\0.100)    ▲ WBU30008(0.245\80°\0.685)

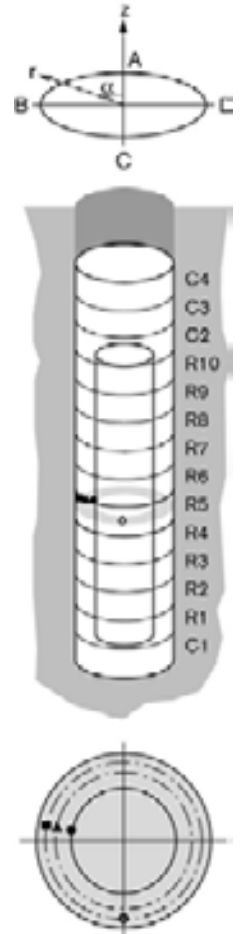
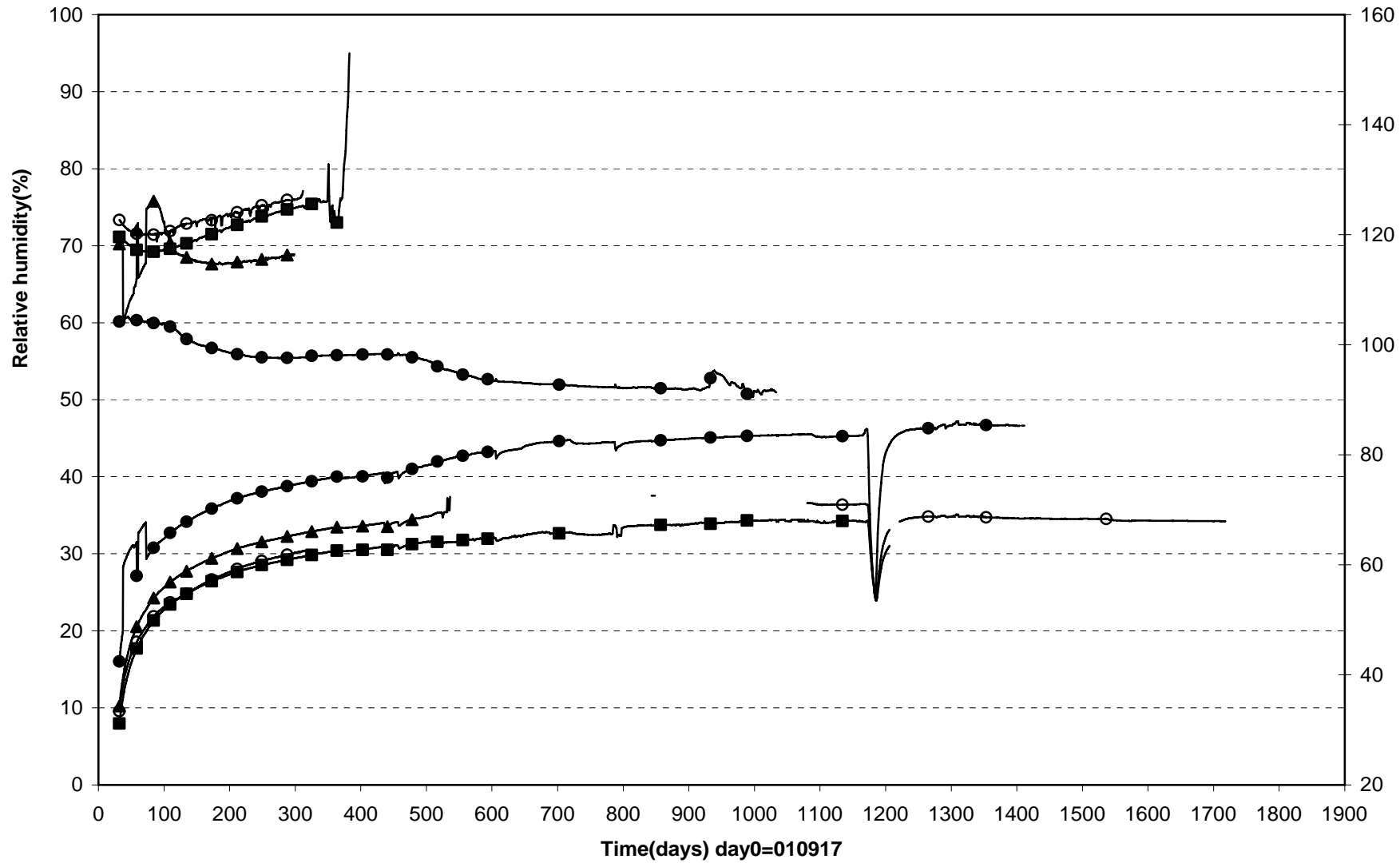
Prototype\Hole 3\Cyl.1 (010917-060601)  
Relative humidity - Rotronic



▲ WBU30010(0.245\170°\0.585) ■ WBU30011(0.245\170°\0.685) ○ WBU30012(0.245\170°\0.785)



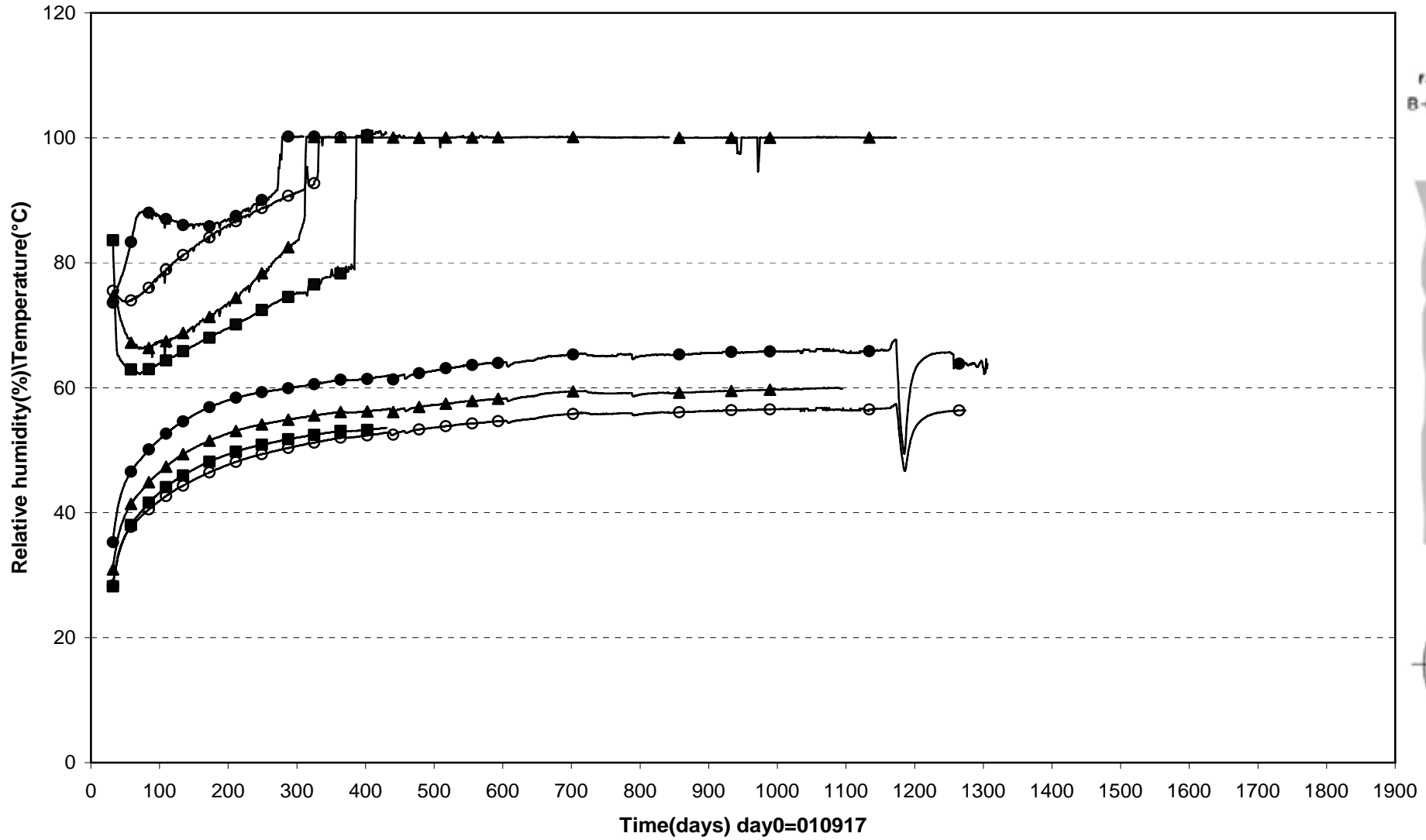
Prototype\Hole 3\Ring 5 (010917-060601)  
 Relative humidity - Rotronic



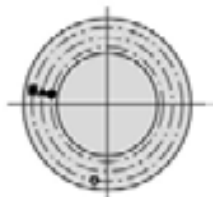
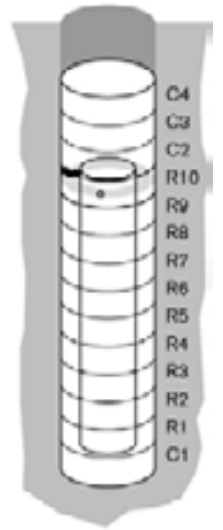
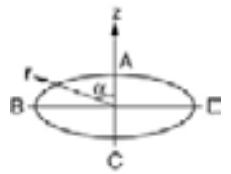
● WBU30016(2.750\80°\0.535) ▲ WBU30017(2.750\80°\0.685) ■ WBU30018(2.750\80°\0.785) ○ WBU30021(2.750\180°\0.785)



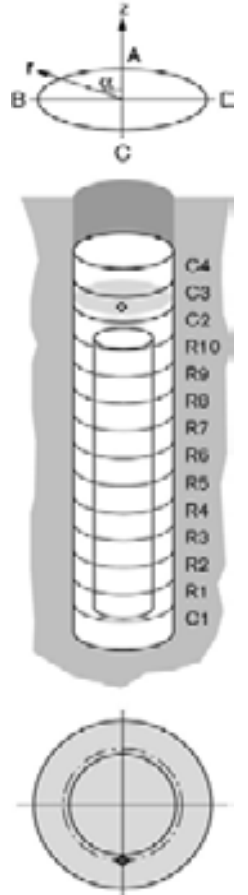
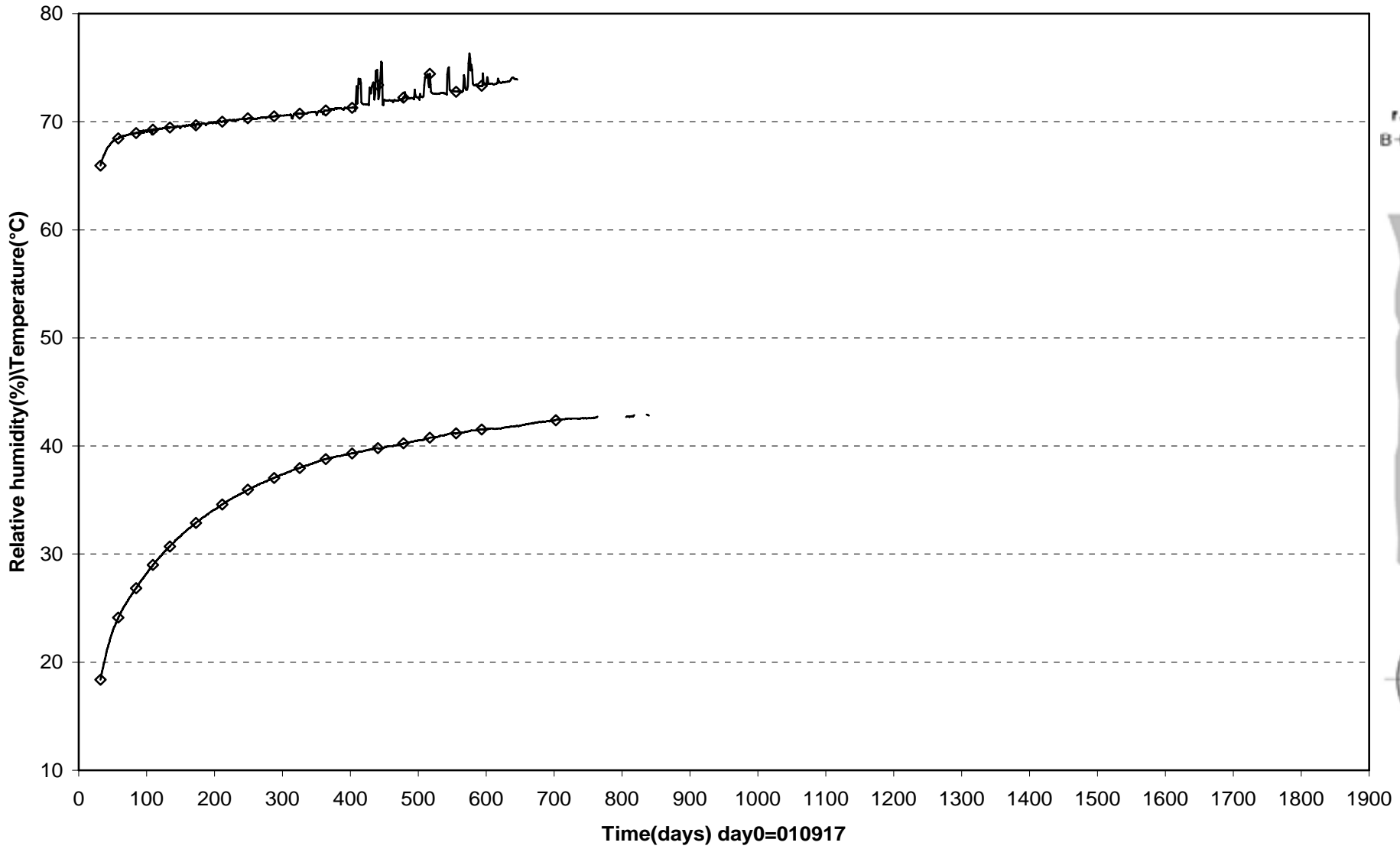
Prototype\Hole 3\Ring 10 (010917-060601)  
 Relative humidity - Rotronic



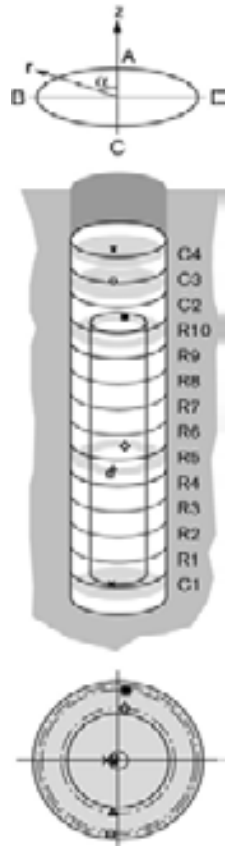
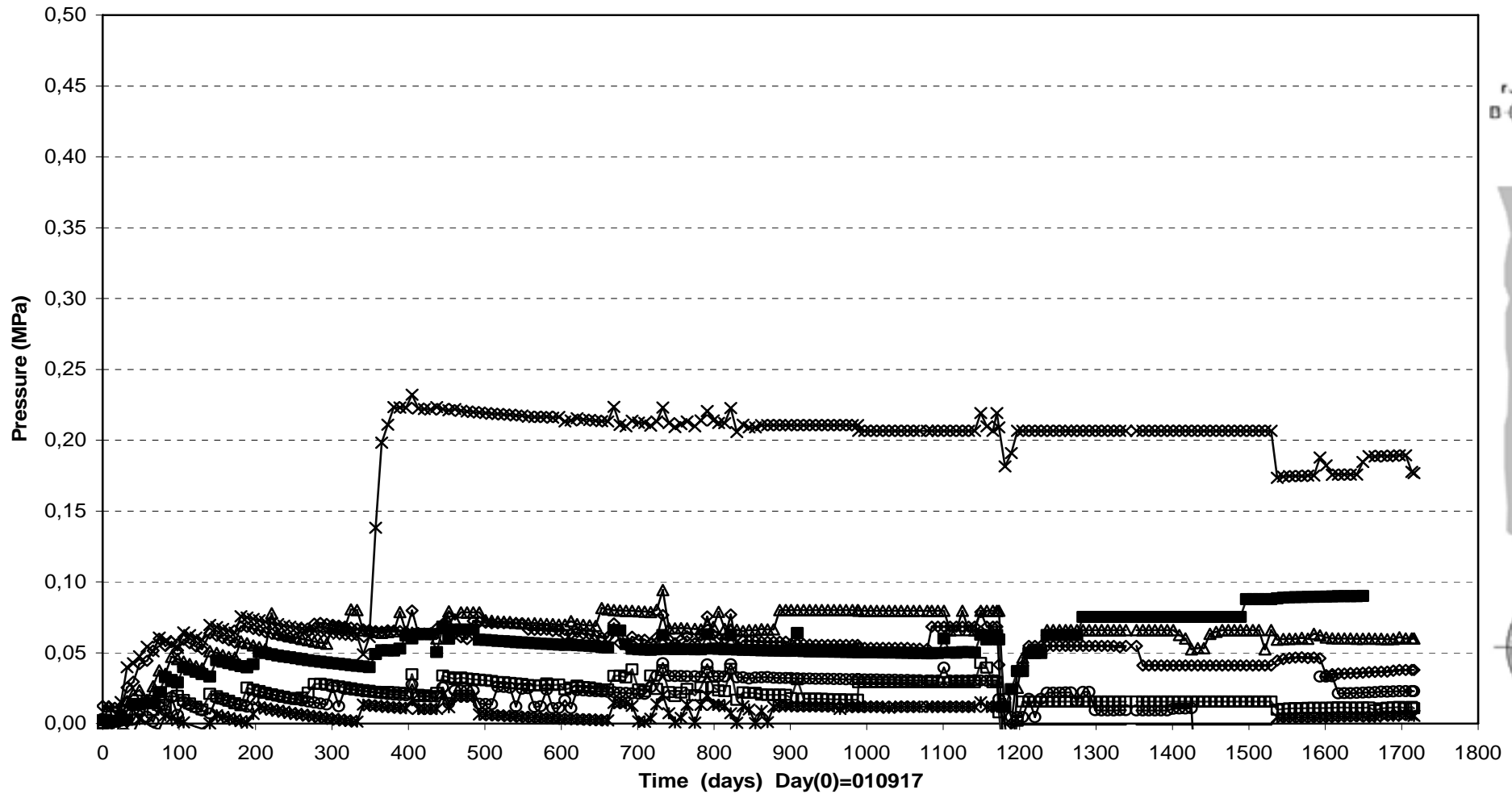
● WBU30027(5.306\80°\0.585) ▲ WBU30028(5.306\80°\0.685) ■ WBU30029(5.306\80°\0.785) ○ WBU30031(5.306\170°\0.785)



Prototype\Hole 3\Cyl.3 (010917-060601)  
 Relative humidity - Rotronic

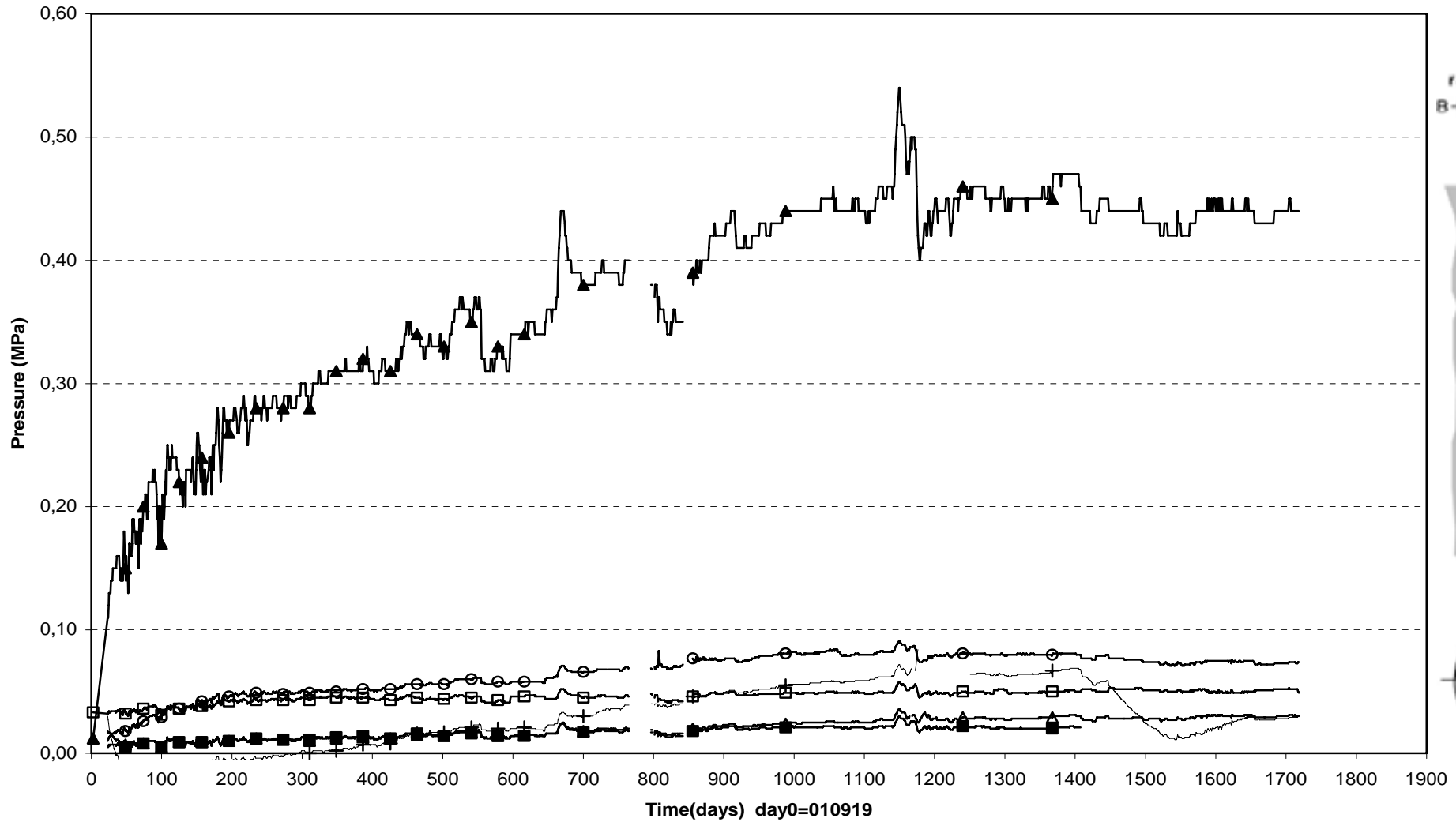


Prototype\Hole 3 (010917-060601)  
Pore pressure - Geokon

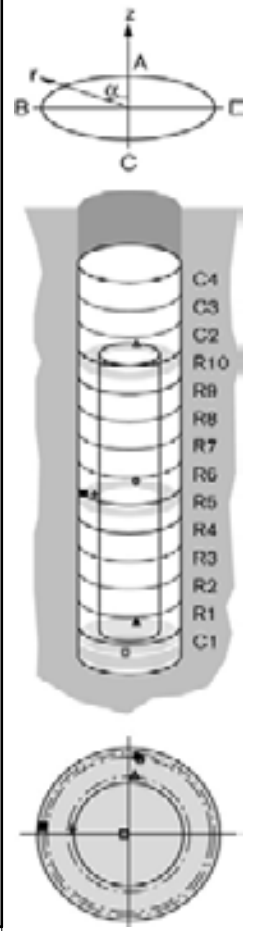


- |  |                                |  |
|--|--------------------------------|--|
| —x— UBU30002(0.245\90°\0.100)              | —◇— UBU30005(2.771\355°\0.585) | —△— UBU30009(2.771\175°\0.535\in the slot) |
| —□— UBU30010(2.771\175°\0.825\in the slot) | —■— UBU30012(5.306\355°\0.785) | —○— UBU30013(6.314\90°\0.050)              |
| —*— UBU30014(6.910\90°\0.050)              |                                |  |

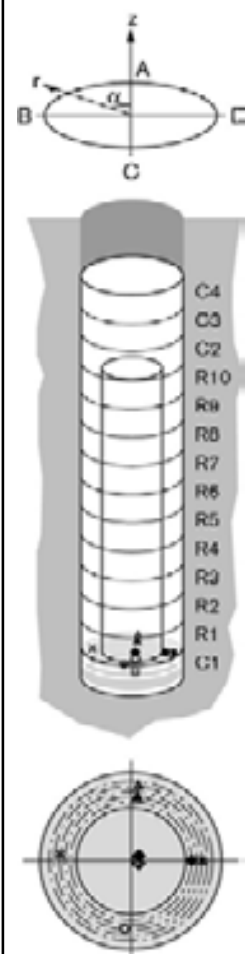
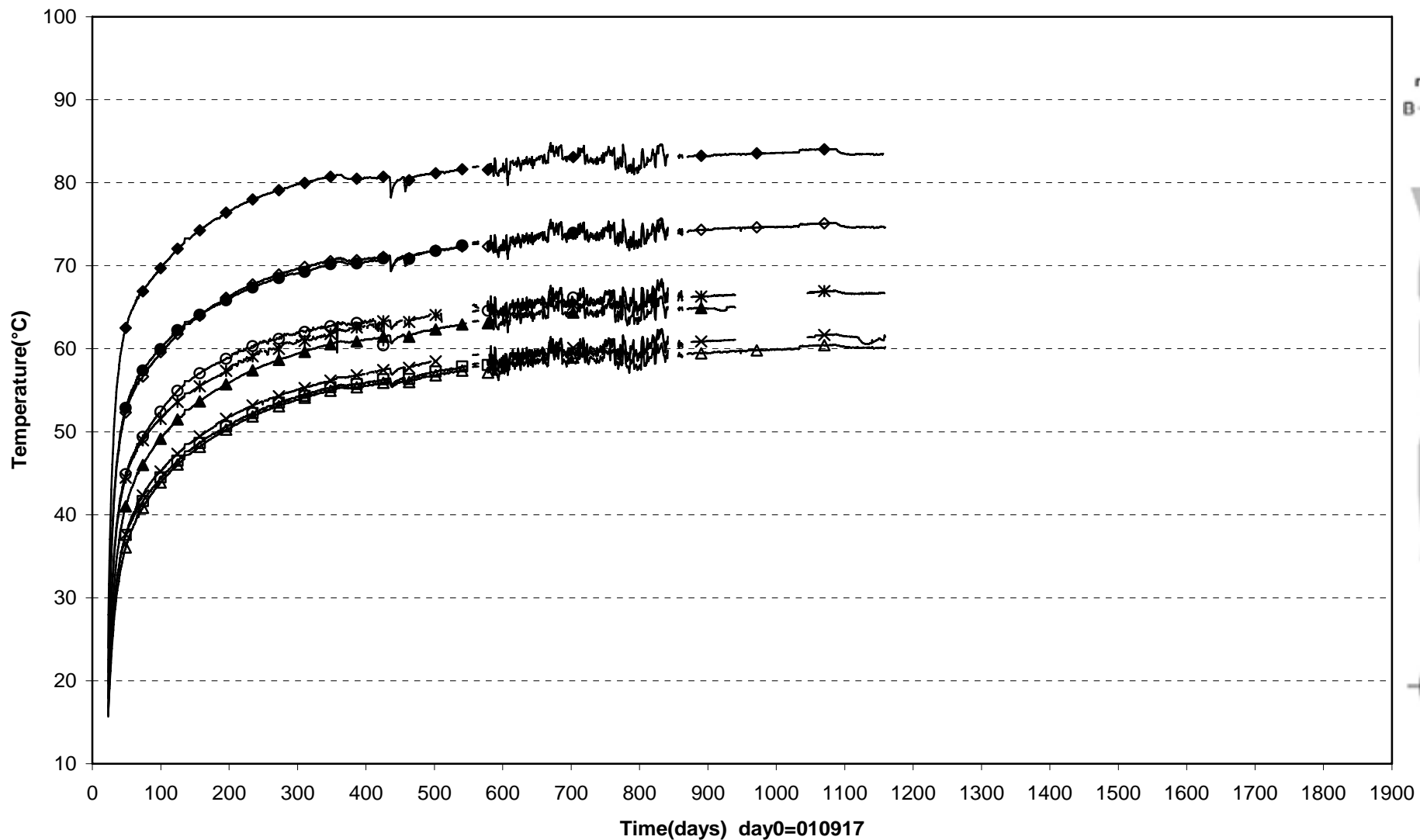
Prototype\Hole 3 (010917-060601)  
Pore pressure - Kulite



- |  |  |                               |
|--|--|-------------------------------|
| □ UBU30001(Cyl.1\90°\0.050)              | ▲ UBU30004(Cyl.1\355°\0.785)             | ○ UBU30006(Ring5\355°\0.785)  |
| + UBU30007(Ring.5\85°\0.535\In the slot) | ■ UBU30008(Ring.5\85°\0.825\In the slot) | △ UBU30011(Ring10\355°\0.585) |



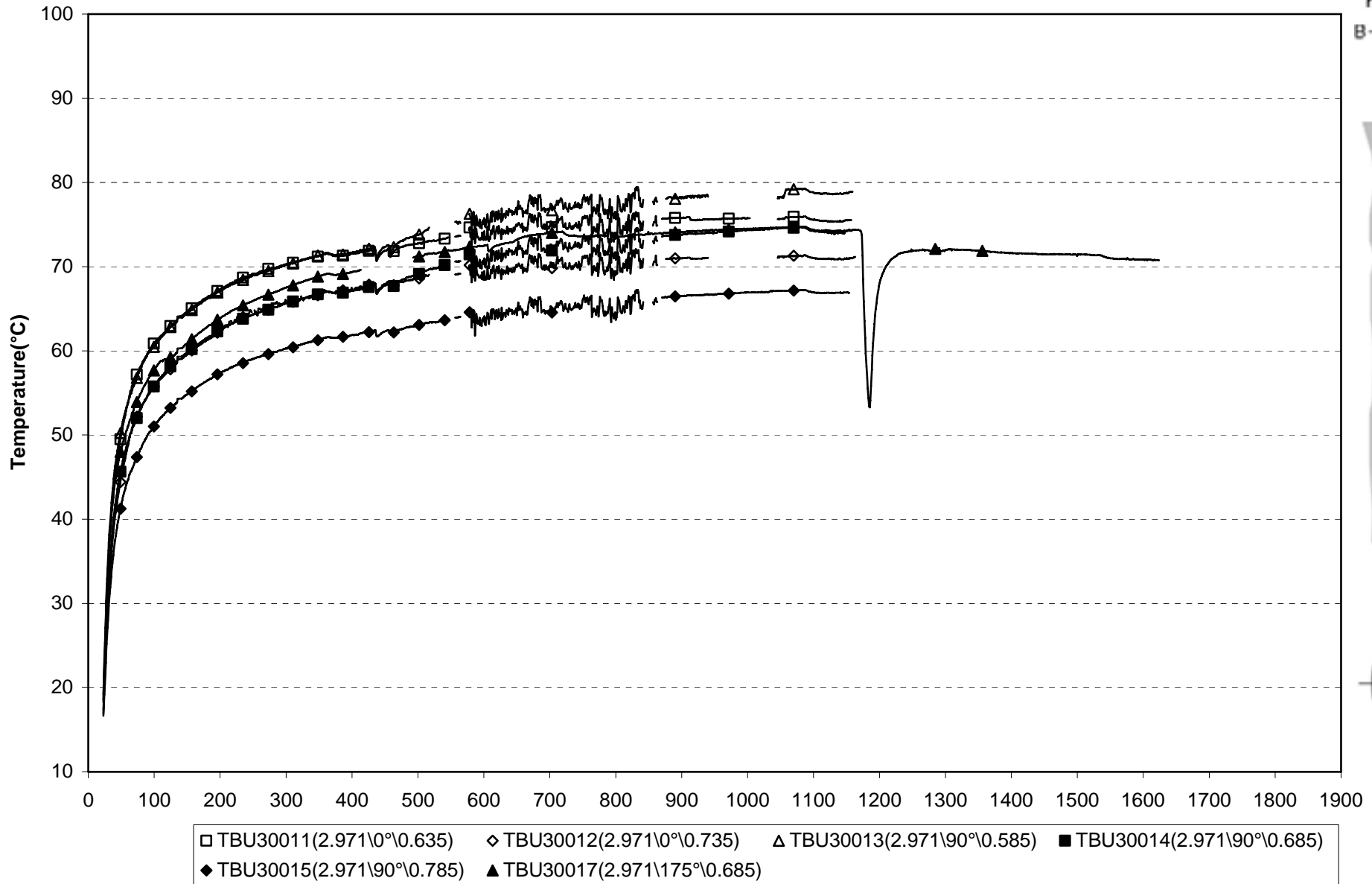
Prototype\Hole 3\Cyl.1 (010917-060601)  
 Temperature - Pentronic



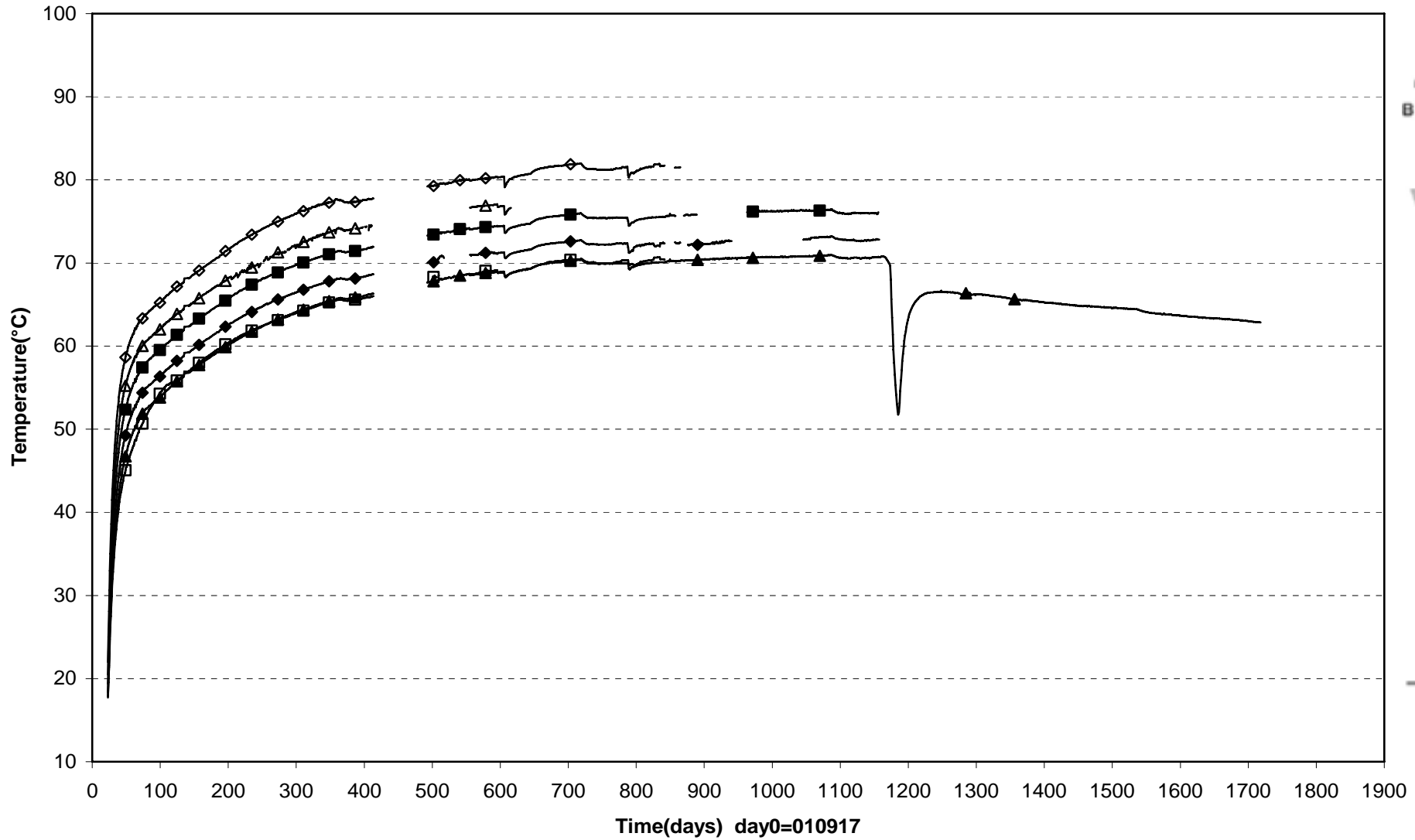
□ TBU30001(0.095\270°\0.050)    ◇ TBU30002(0.295\270°\0.050)    ◆ TBU30003(0.445\270°\0.050)    ▲ TBU30004(Cyl.1\355°\0.635)    △ TBU30005(Cyl.1\355°\0.735)  
 × TBU30006(Cyl.1\85°\0.685)    ○ TBU30007(Cyl.1\175°\0.685)    ● TBU30008(Cyl.1\270°\0.585)    ✱ TBU30009(Cyl.1\270°\0.685)

c

Prototype\Hole 3\Ring5 (010917-060601)  
 Temperature - Pentronic

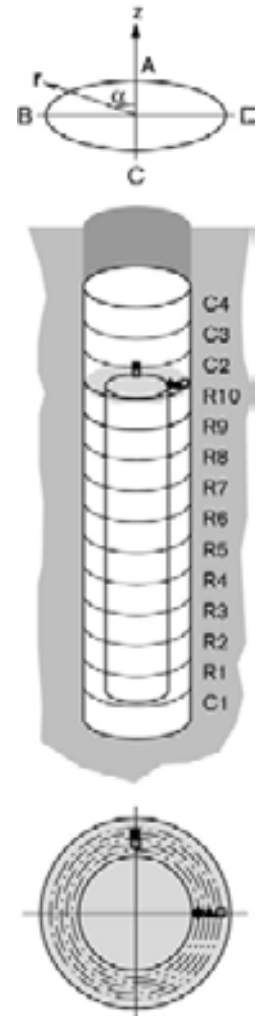
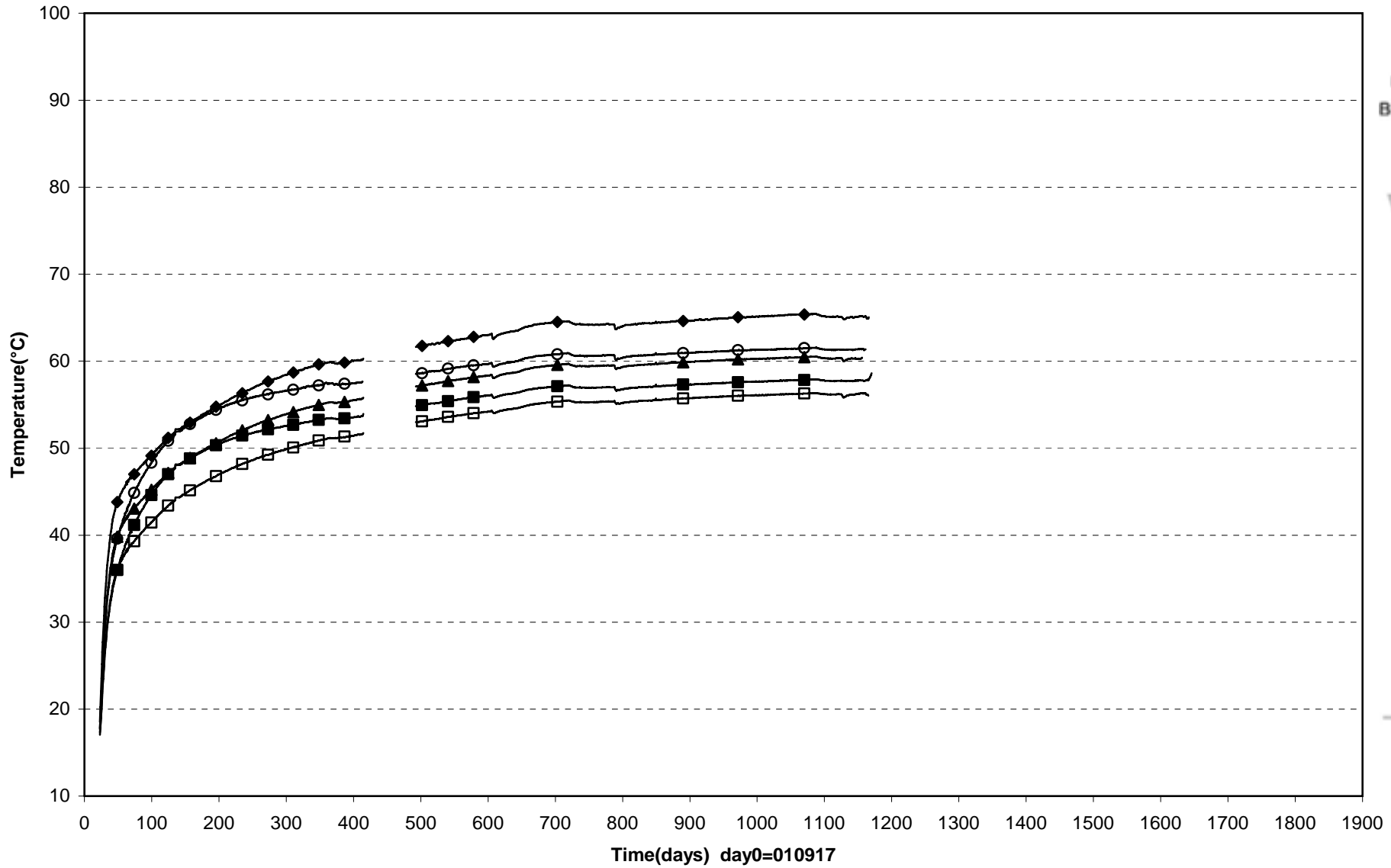


Prototype\Hole 3\Ring5 (010917-060601)  
 Temperature - Pentronic



□ TBU30018(2.971\175°\0.735)    ◇ TBU30019(2.971\270°\0.585)    △ TBU30020(2.971\270°\0.635)    ■ TBU30021(2.971\270°\0.685)  
 ◆ TBU30022(2.971\270°\0.735)    ▲ TBU30023(2.971\270°\0.785)

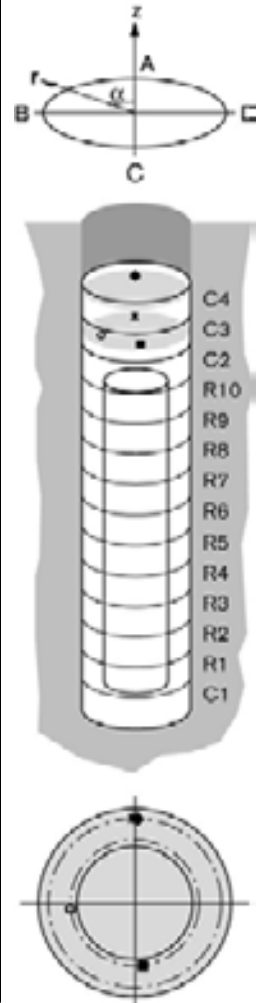
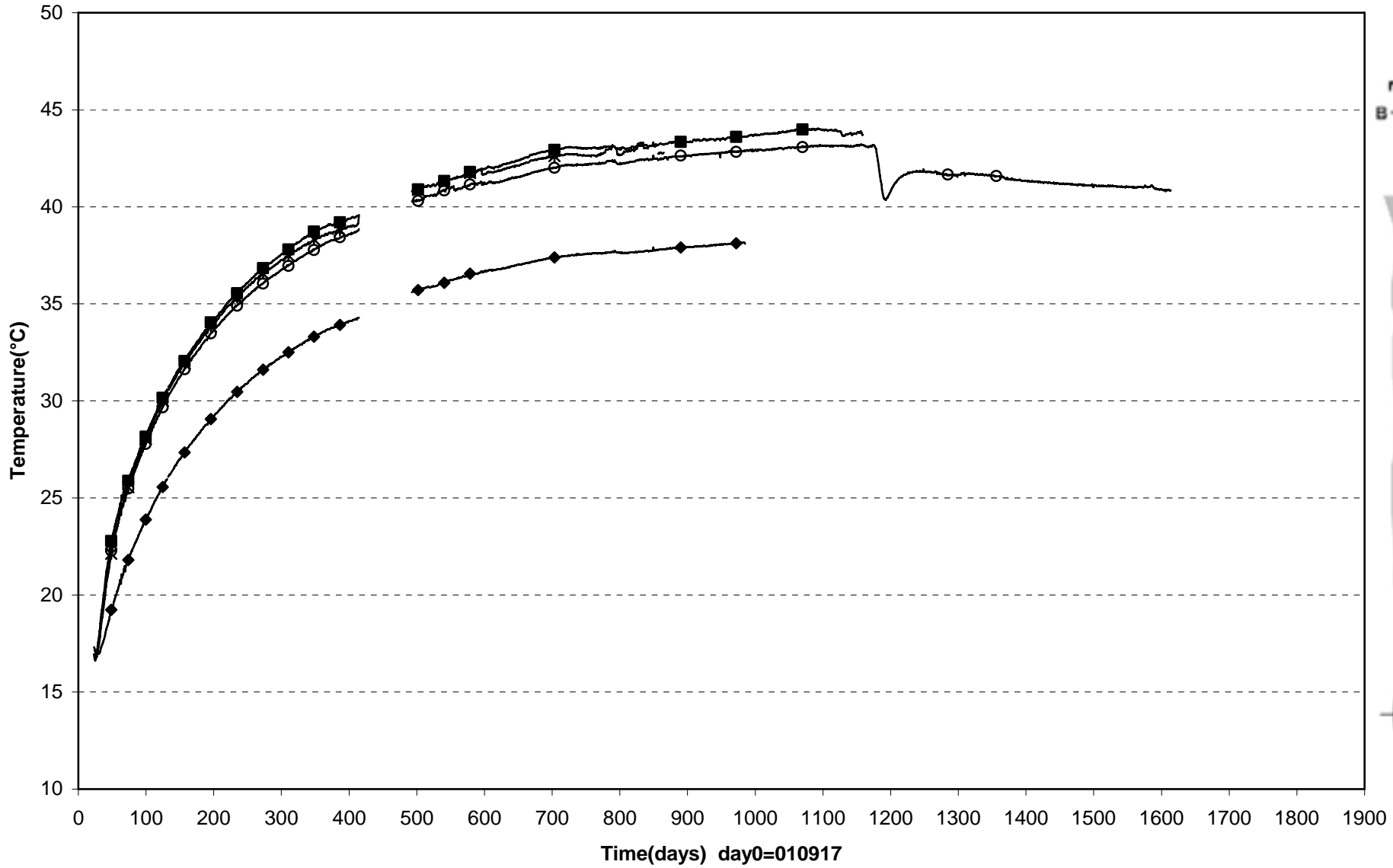
Prototype\Hole 3\Ring10 (010917-060601)  
 Temperature - Pentronic



○ TBU30024(5.504\0°\0.635) ■ TBU30025(5.504\0°\0.735) ◆ TBU30026(5.504\270°\0.585) ▲ TBU30027(5.504\270°\0.685) □ TBU30028(5.504\270°\0.785)

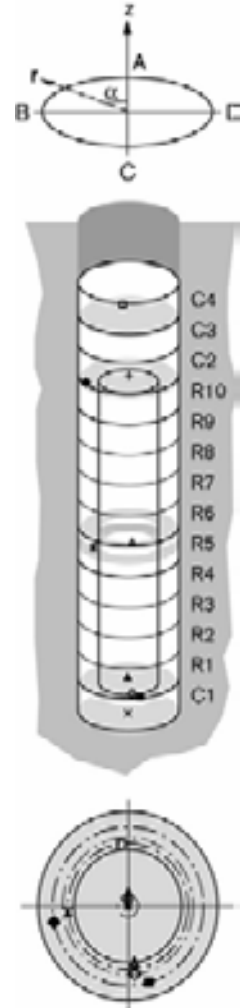
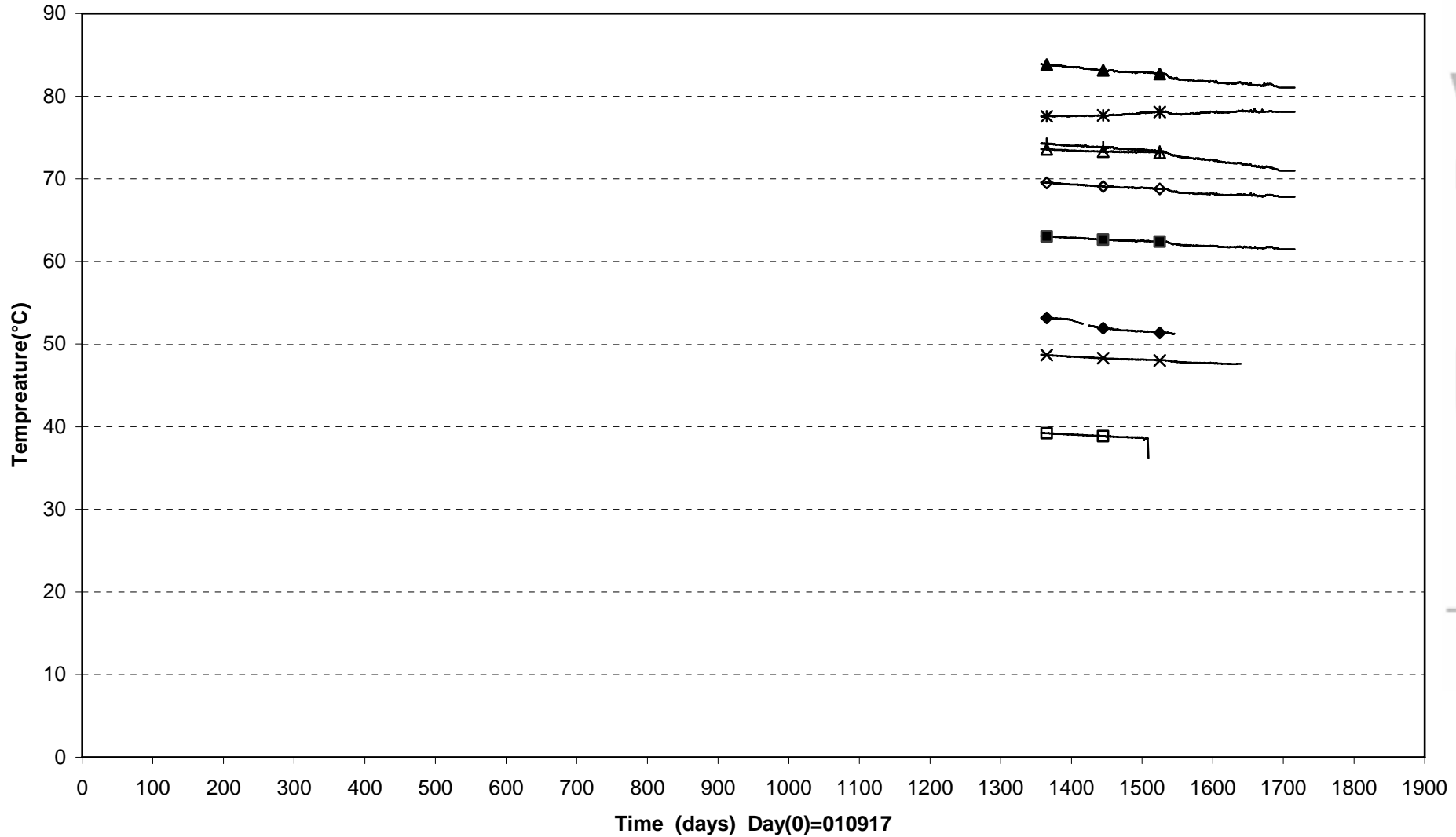


Prototype\Hole 3\Cyl.3 and Cyl.4 (010917-060601)  
 Temperature - Pentronic



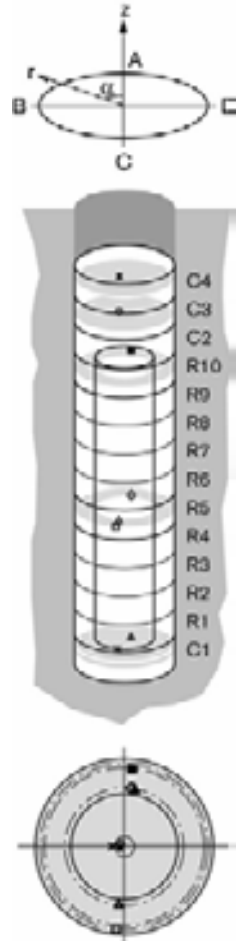
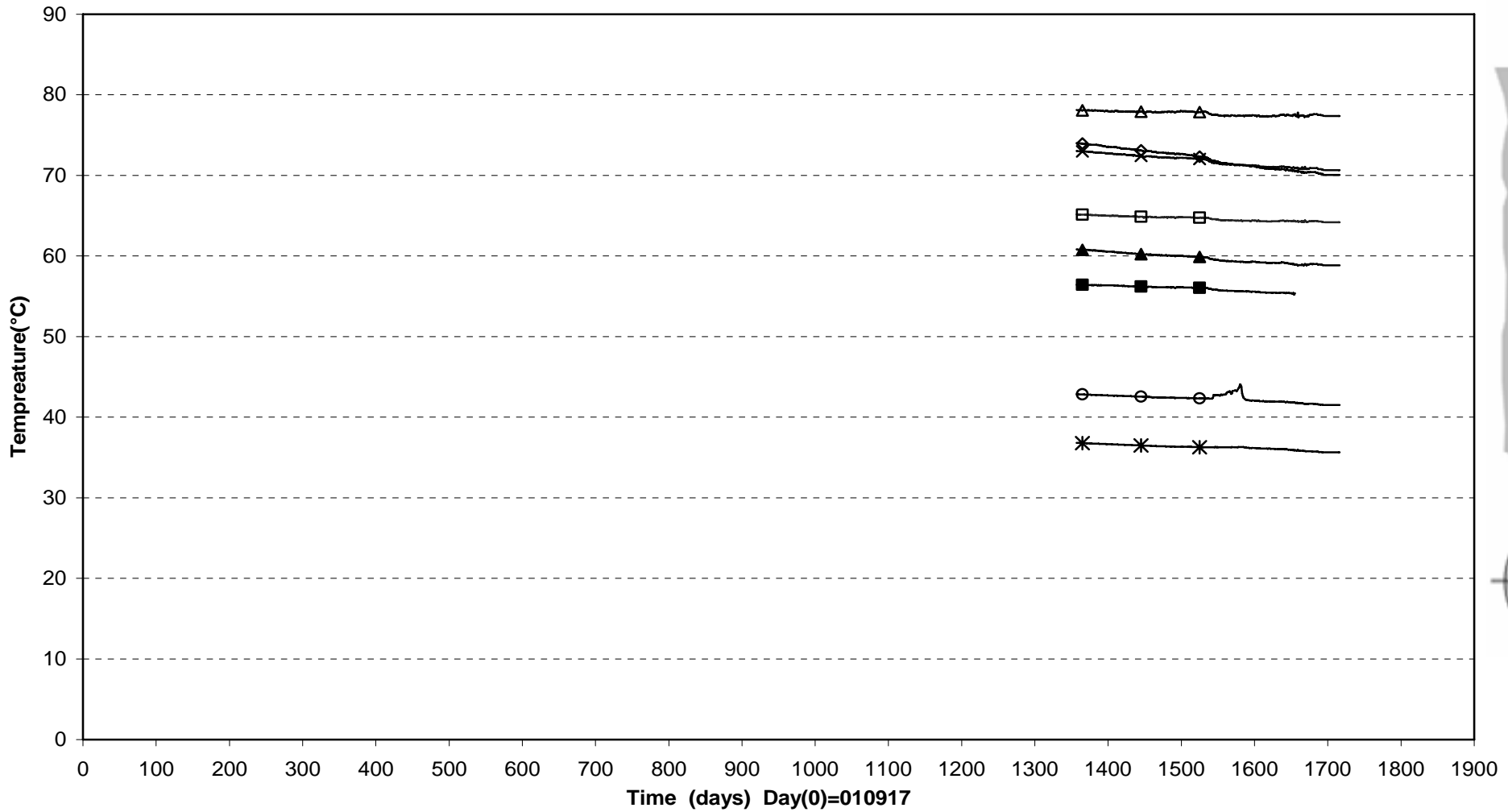
× TBU30029(6.314\0°\0.785) ○ TBU30030(6.314\95°\0.585) ■ TBU30031(6.314\185°\0.585) ◆ TBU30032(7.015\0°\0.785)

Prototype\Hole 3 (010917-060601)  
 Tempreature - Geokon



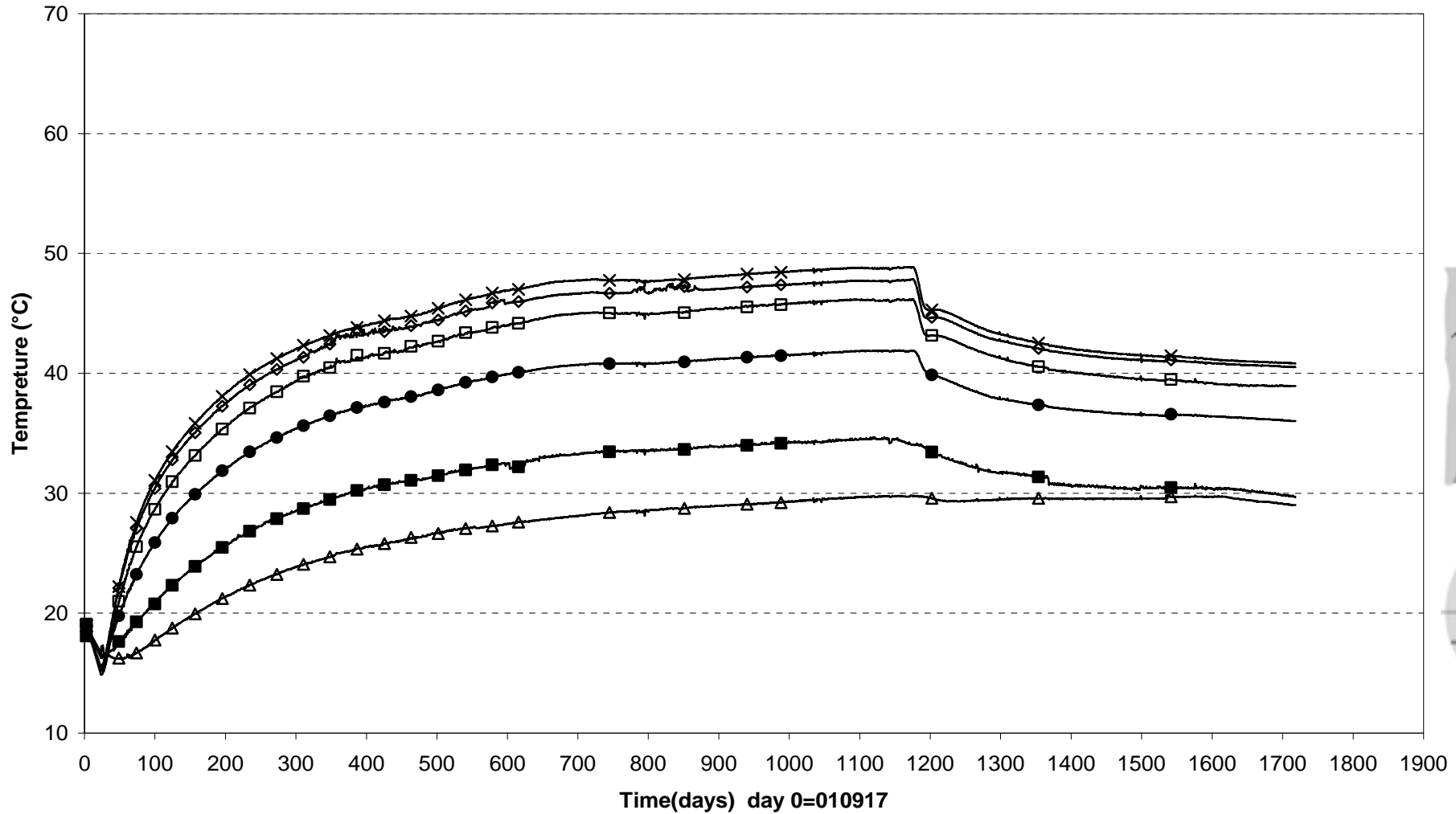
× PBU30001(0\0°\0)	▲ PBU30002(0.495\0°\0.100)	◇ PBU30008(0.495\185°\0.635)	■ PBU30009(0.495\195°\0.735)	✱ PBU30013(2.771\95°\0.585)
△ PBU30015(3.021\185°\0.535)	+ PBU30017(5.556\0°\0.050)	◆ PBU30022(5.556\100°\0.735)	□ PBU30026(6.654\5°\0.585)	

Prototype\Hole 3 (010917-060601)  
 Tempreture - Geokon

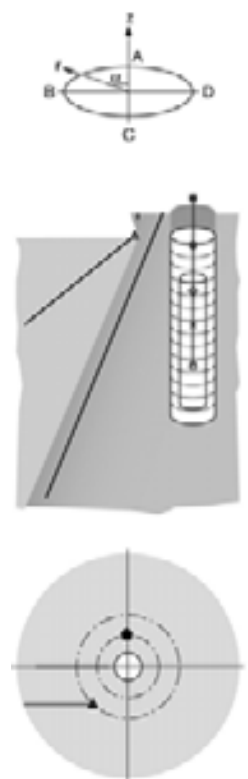


× UBU30002(0.245\90°\0.100)	▲ UBU30003(0.335\355°\0.585)	◇ UBU30005(2.771\355°\0.585)	△ UBU30009(2.771\175°\0.535\in the slot)
□ UBU30010(2.771\175°\0.825\in the slot)	■ UBU30012(5.306\355°\0.785)	○ UBU30013(6.314\90°\0.050)	✱ UBU30014(6.910\90°\0.050)

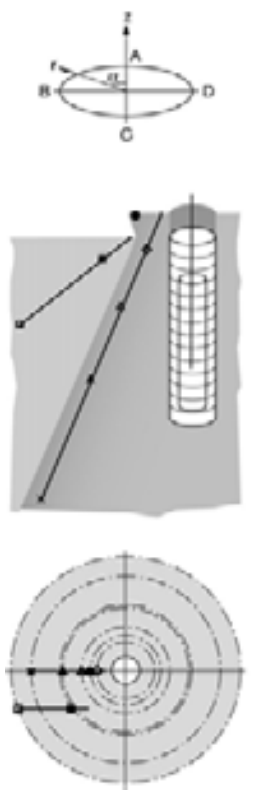
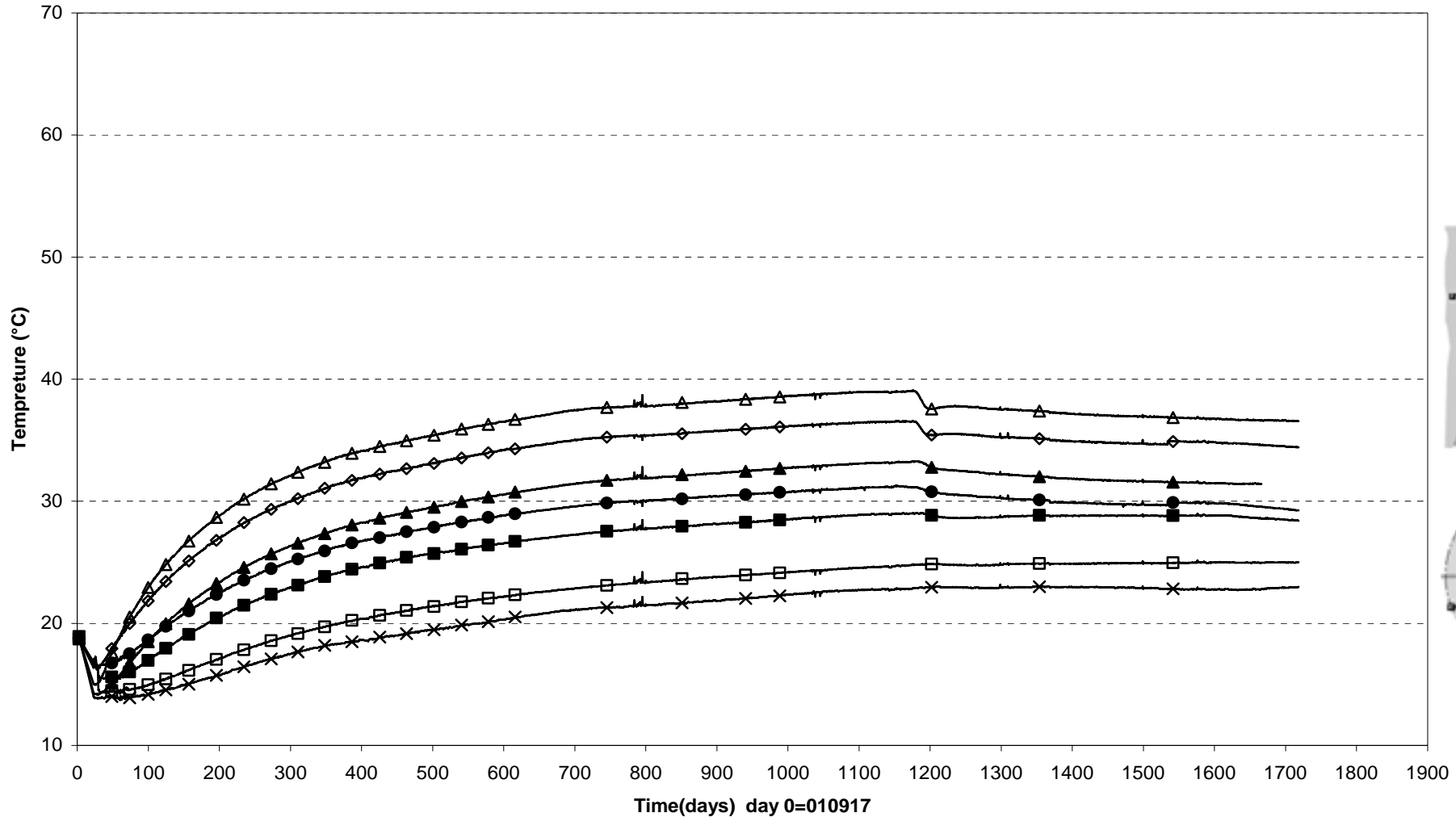
Prototype\Rock\Hole 3 (010917-060601)  
 Temperature - Pentronic



Δ TROA2150(7.958\134°\3.284)    ● TROA2140 (5.979\1°\1.999)    ◇ TROA2130(4.230\2°\1.981)    × TROA2120(2.840\2°\1.967)  
 □ TROA2110(1.170\3°\1.950)    ■ TROA1850 (7.889\0°\2.019)

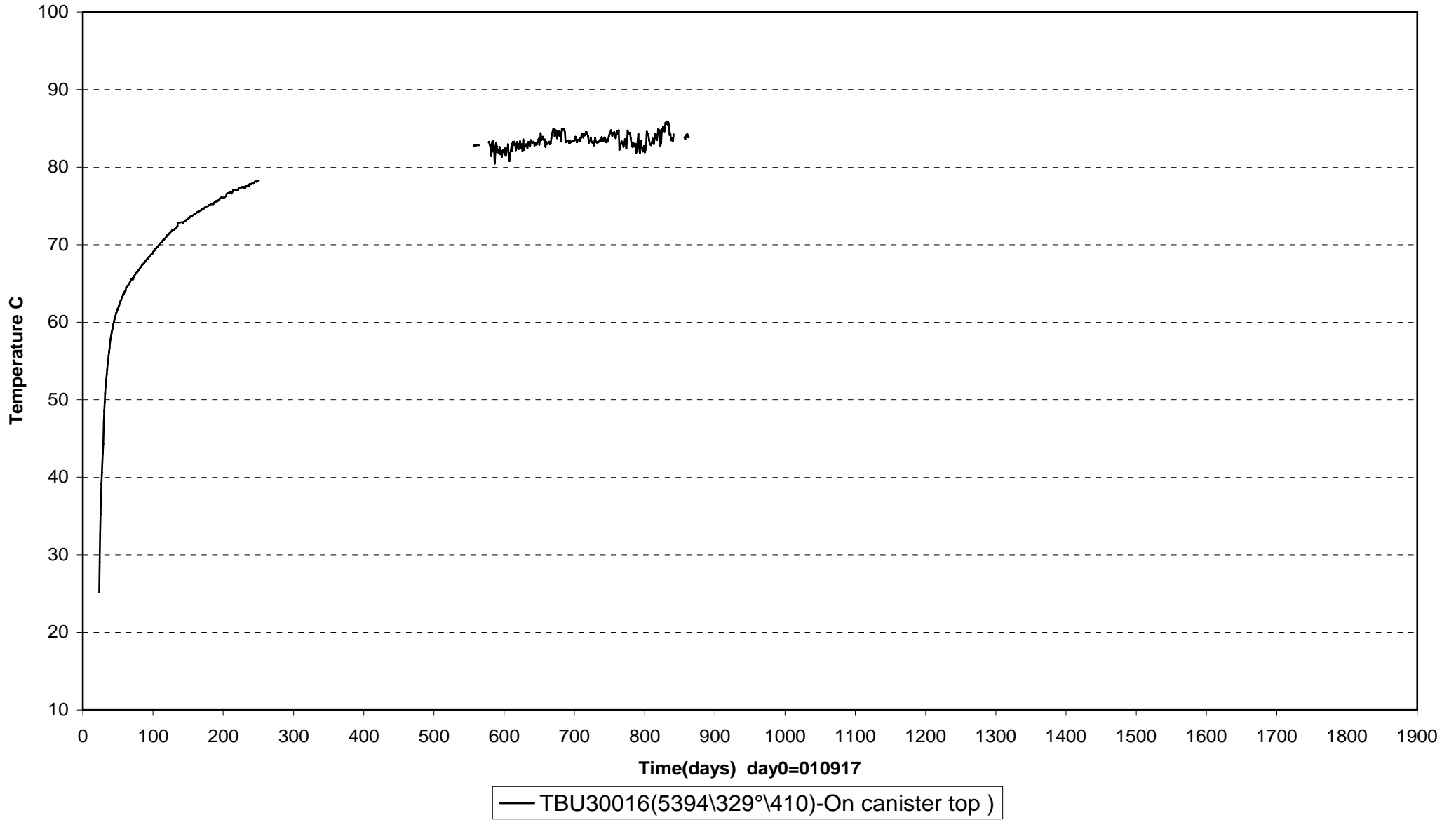


Prototype\Rock\Hole 3 (010917-060601)  
 Temperature - Pentronic

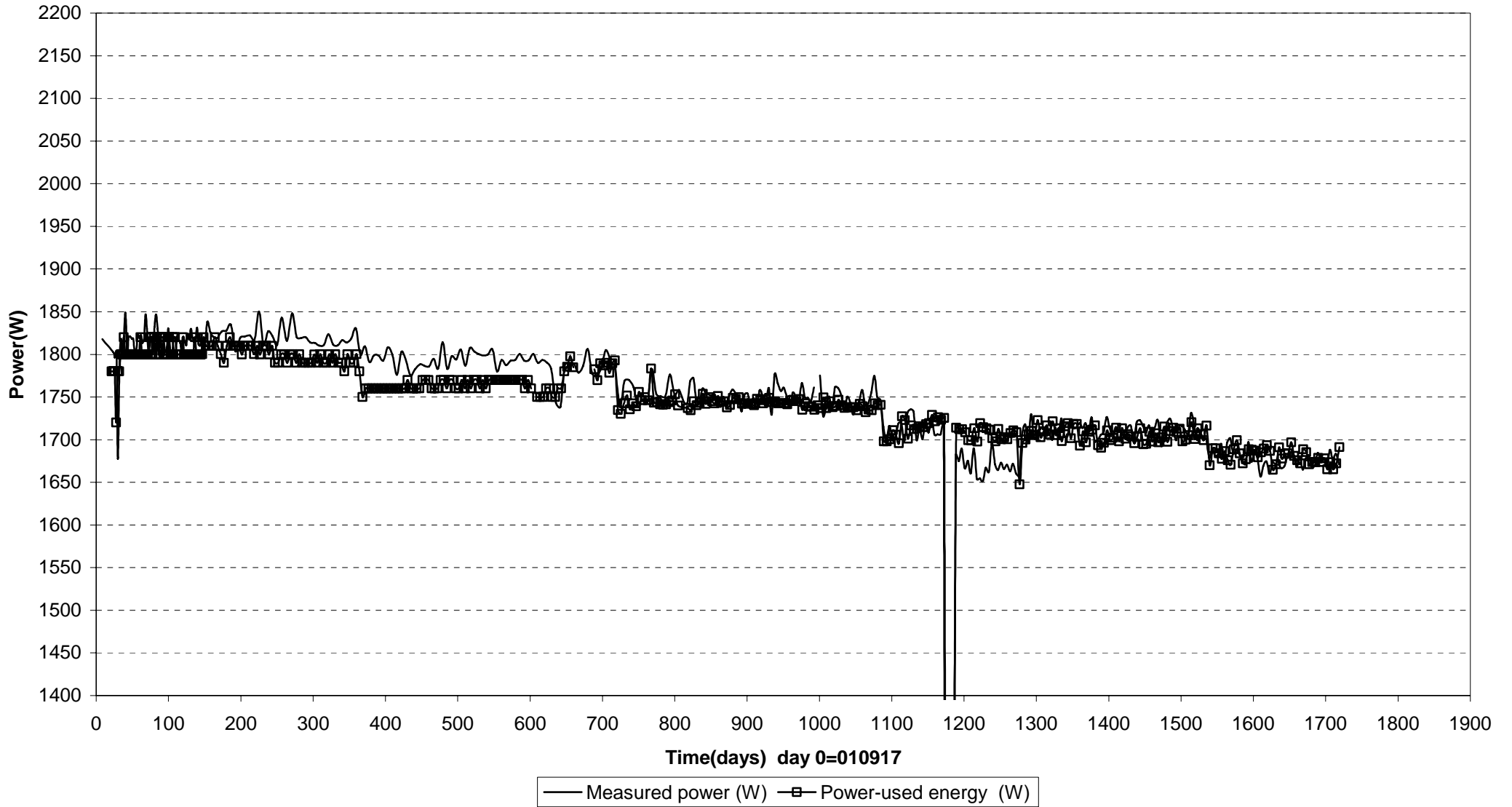


● TROA2330(7.924\90°\2.169)	◇ TROA2320 (6.632\90°\1.787)	□ TROA2310(4.640\109°\7.111)	■ TROA2440 (7.174\124°\4.088)
△ TROA2430 (4.319\90°\2.737)	▲ TROA2420(1.451\89°\3.914)	× TROA2410(-3.295\89°\5.861)	

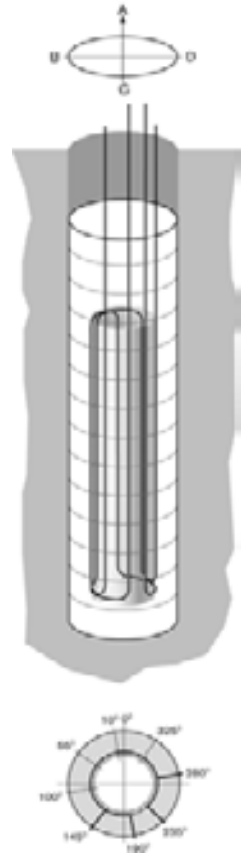
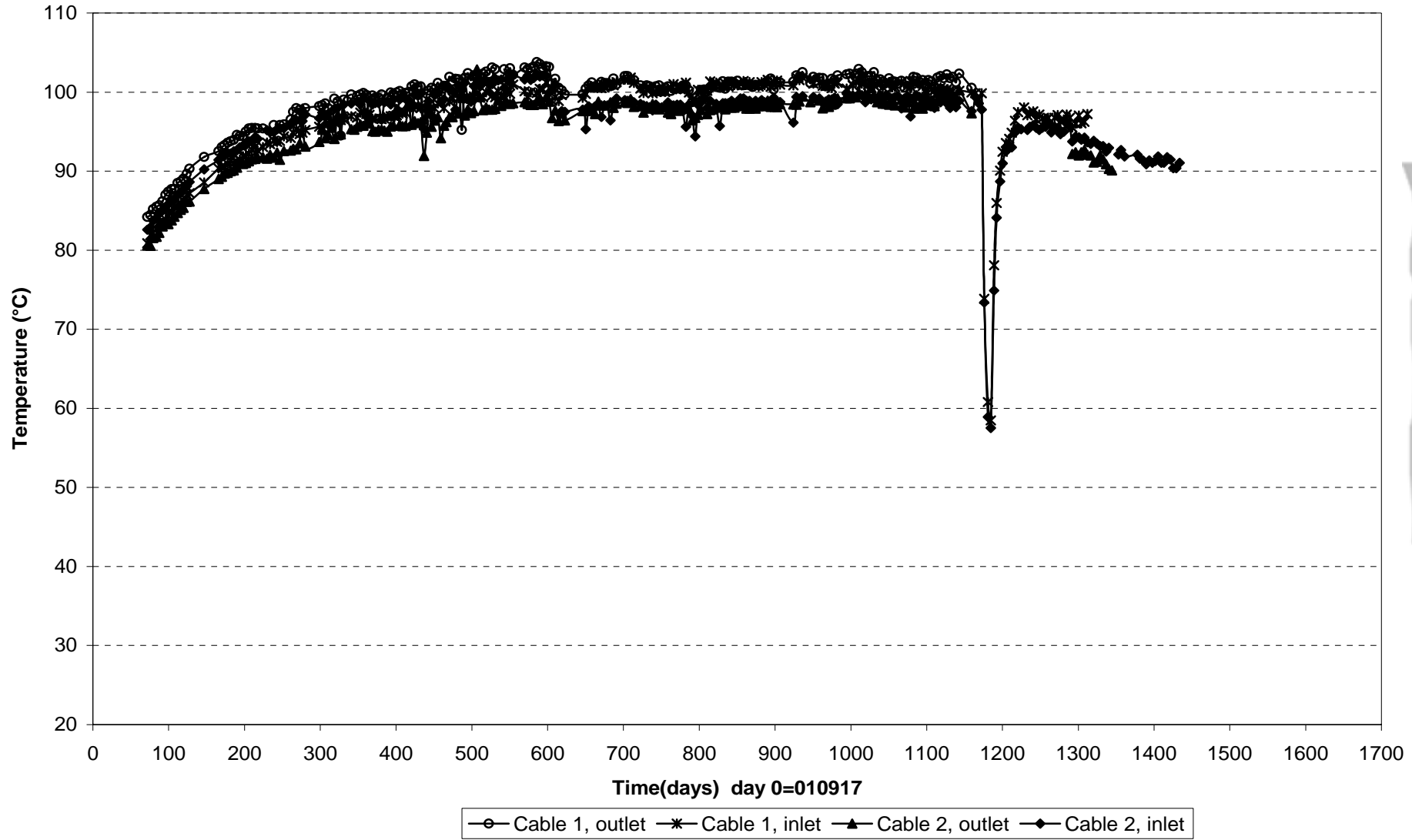
Prototype\Hole 3\ On canister top (010917-060601)  
Temperature - Pentronic



Prototype\ Hole 3 (010917-060601)  
Canister power

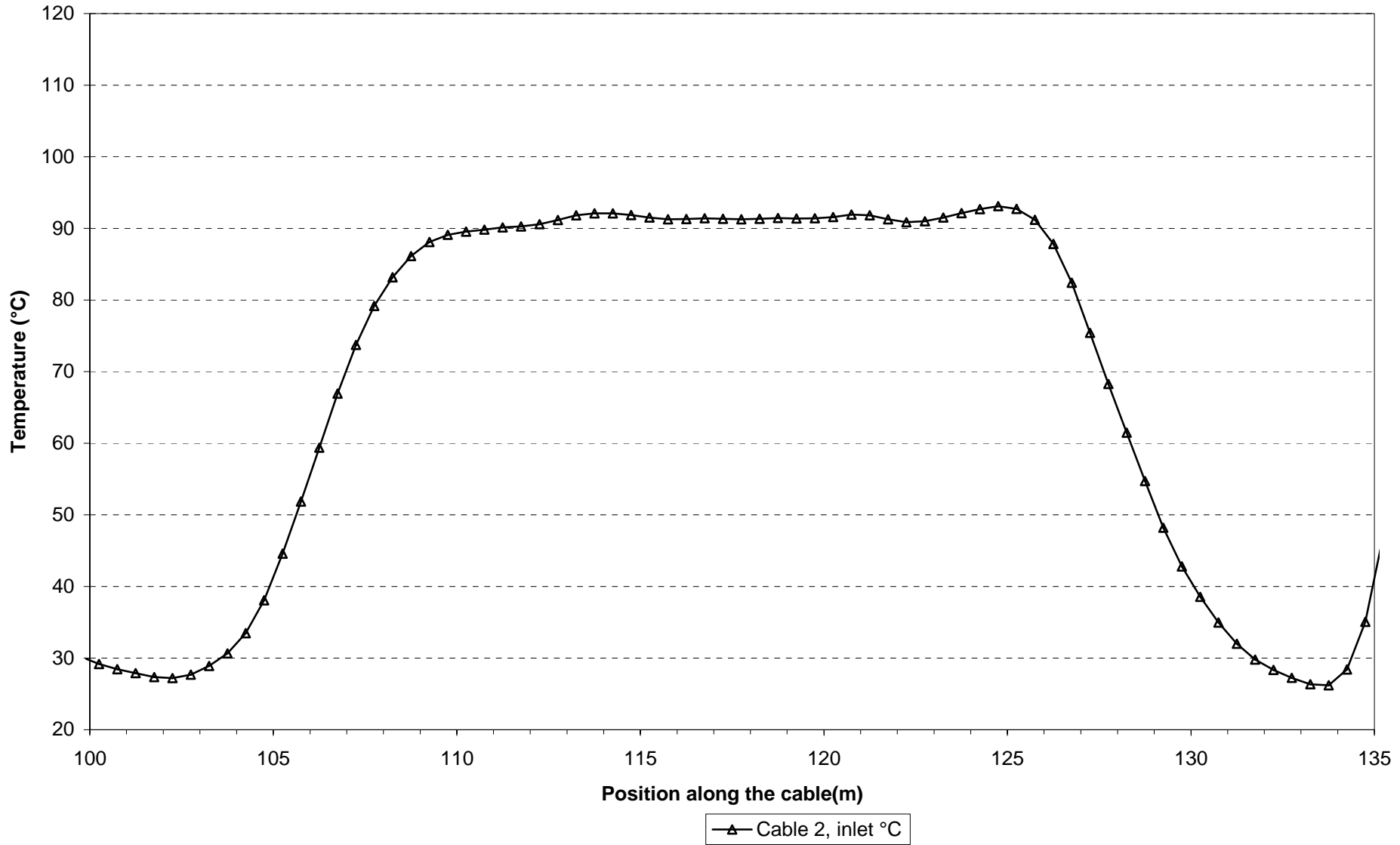


Prototype\ Hole 3 \Canister (010917-060601)  
Max. temperature on the canister surface - Optical fibre cables





Prototype\ Hole 3 \Canister (050601)  
Temperature profile on the canister surface - Optical fiber cables



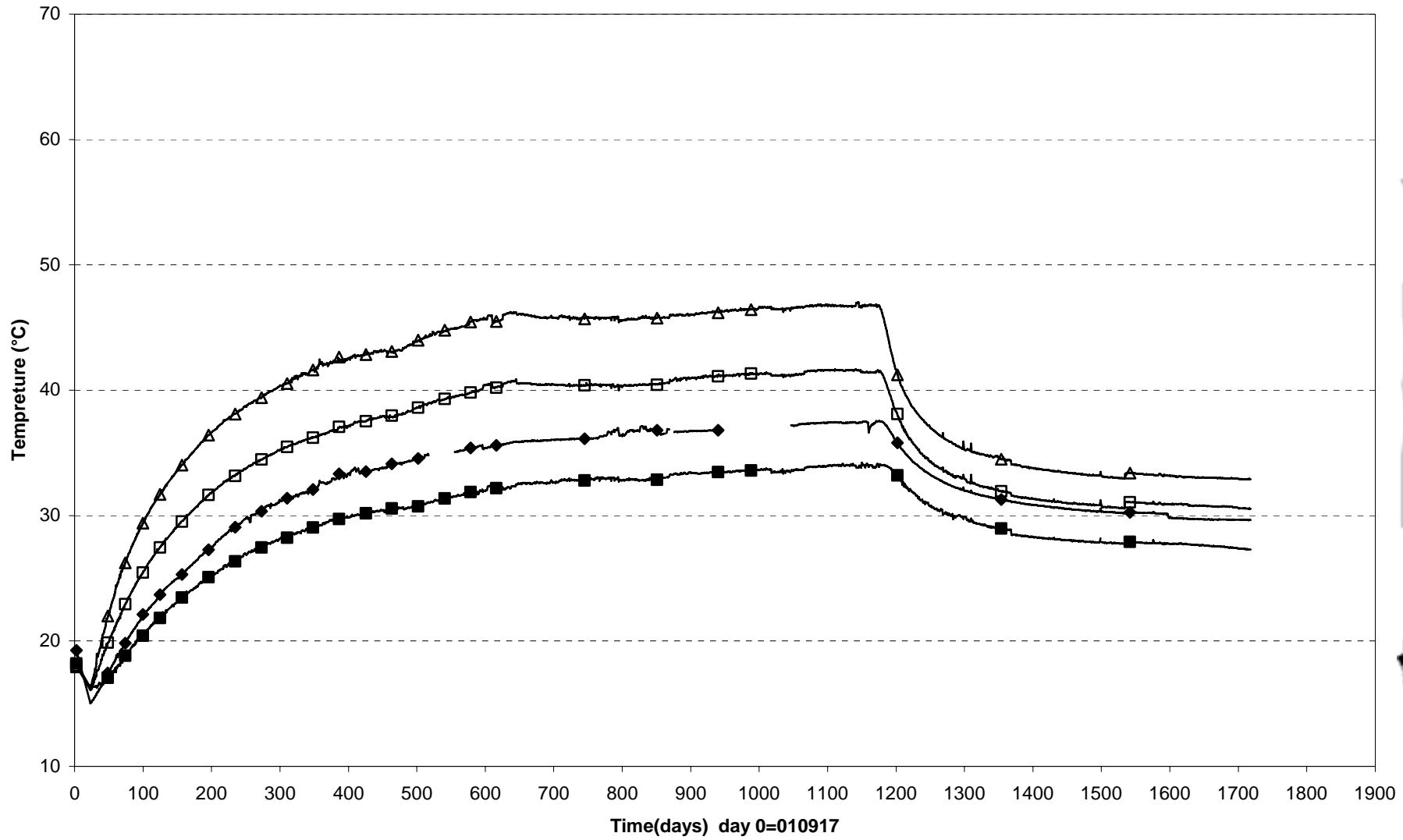


## **Appendix 3**

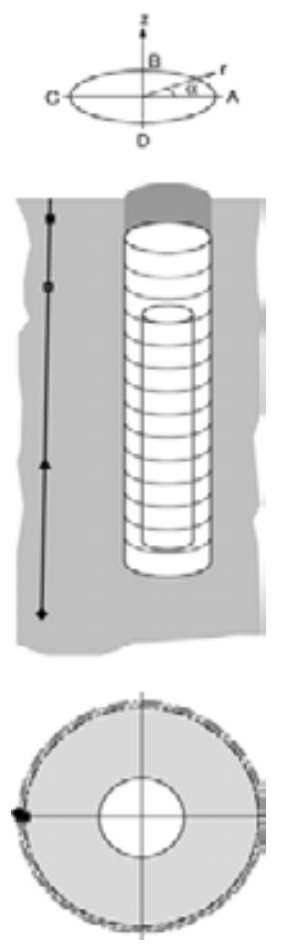
**Dep. holes 2 and 4**



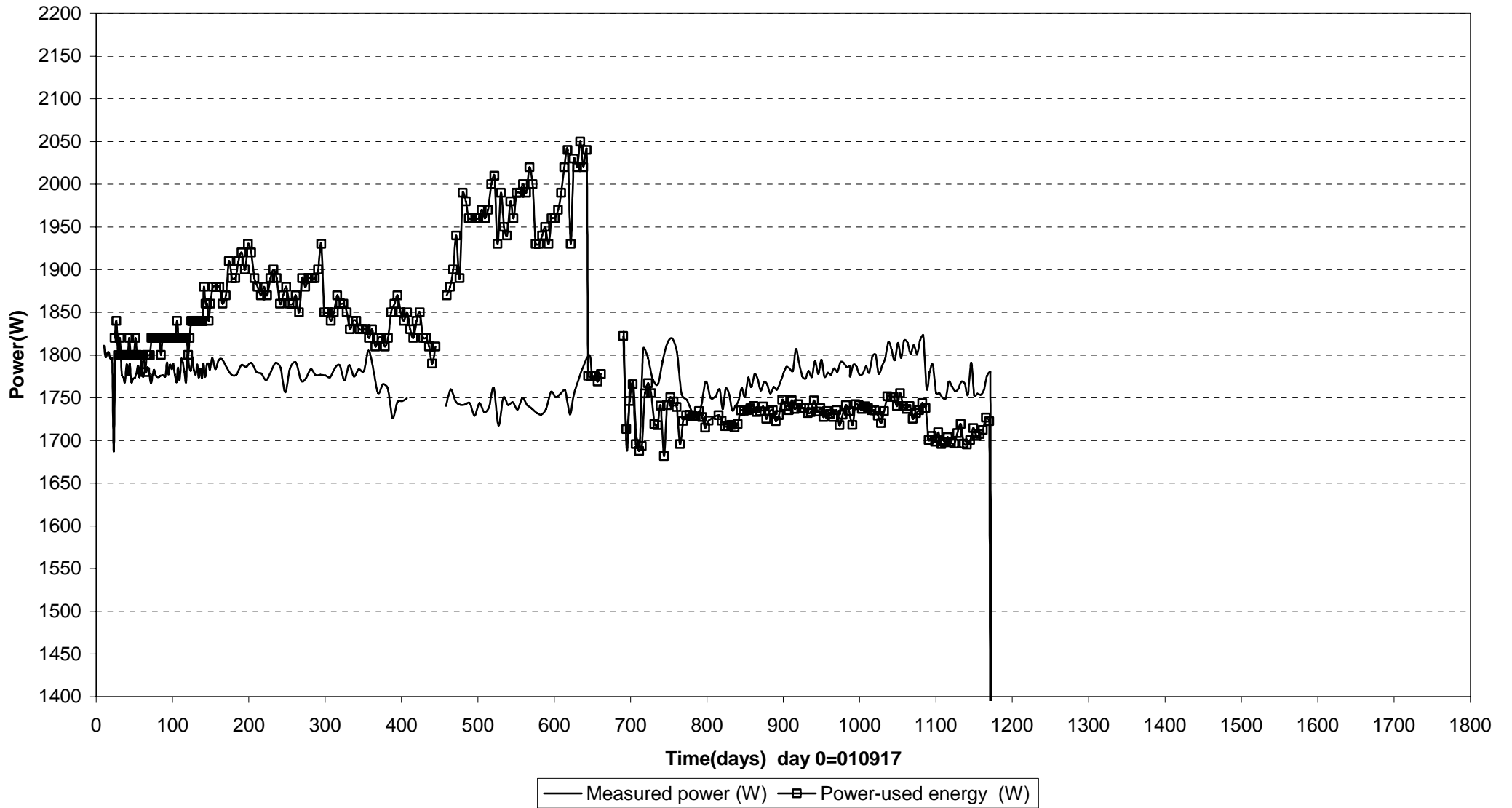
Prototype\Rock\Hole 2 (010917-060601)  
 Temperature - Pentronic



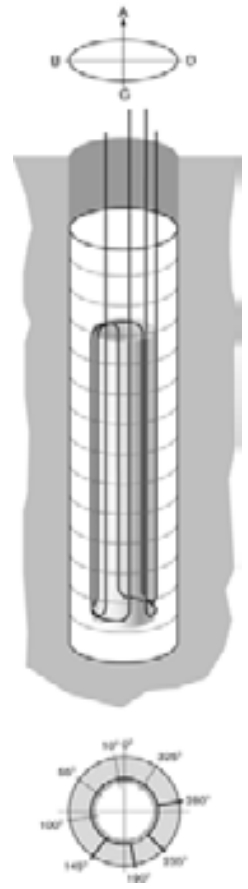
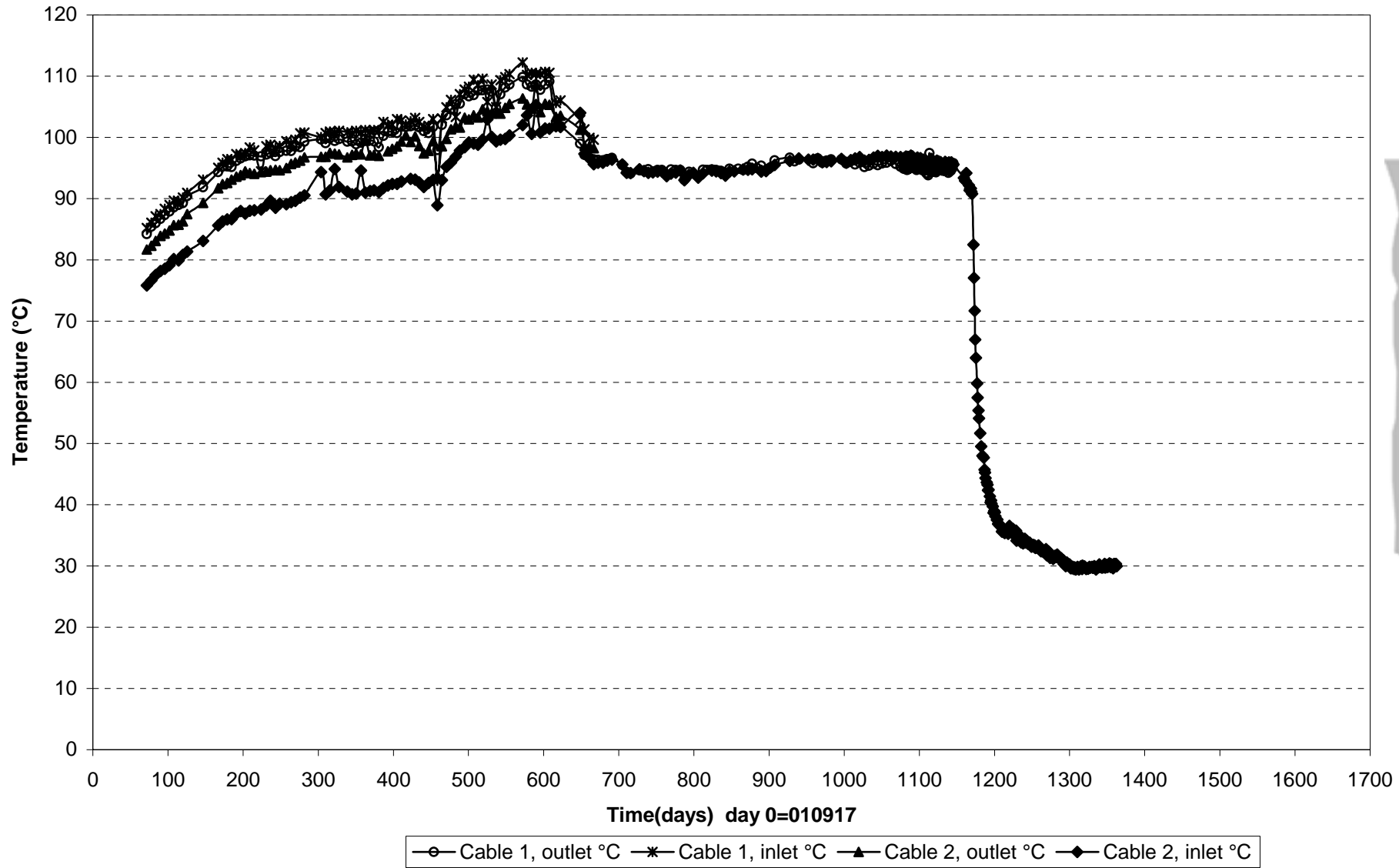
TROA1840(7.587\180°\2.404)    
  TROA1830 (6.087\180°\2.427)    
  TROA1820(2.138\179°\2.490)    
  TROA1810 (-1.162\179°\2.542)



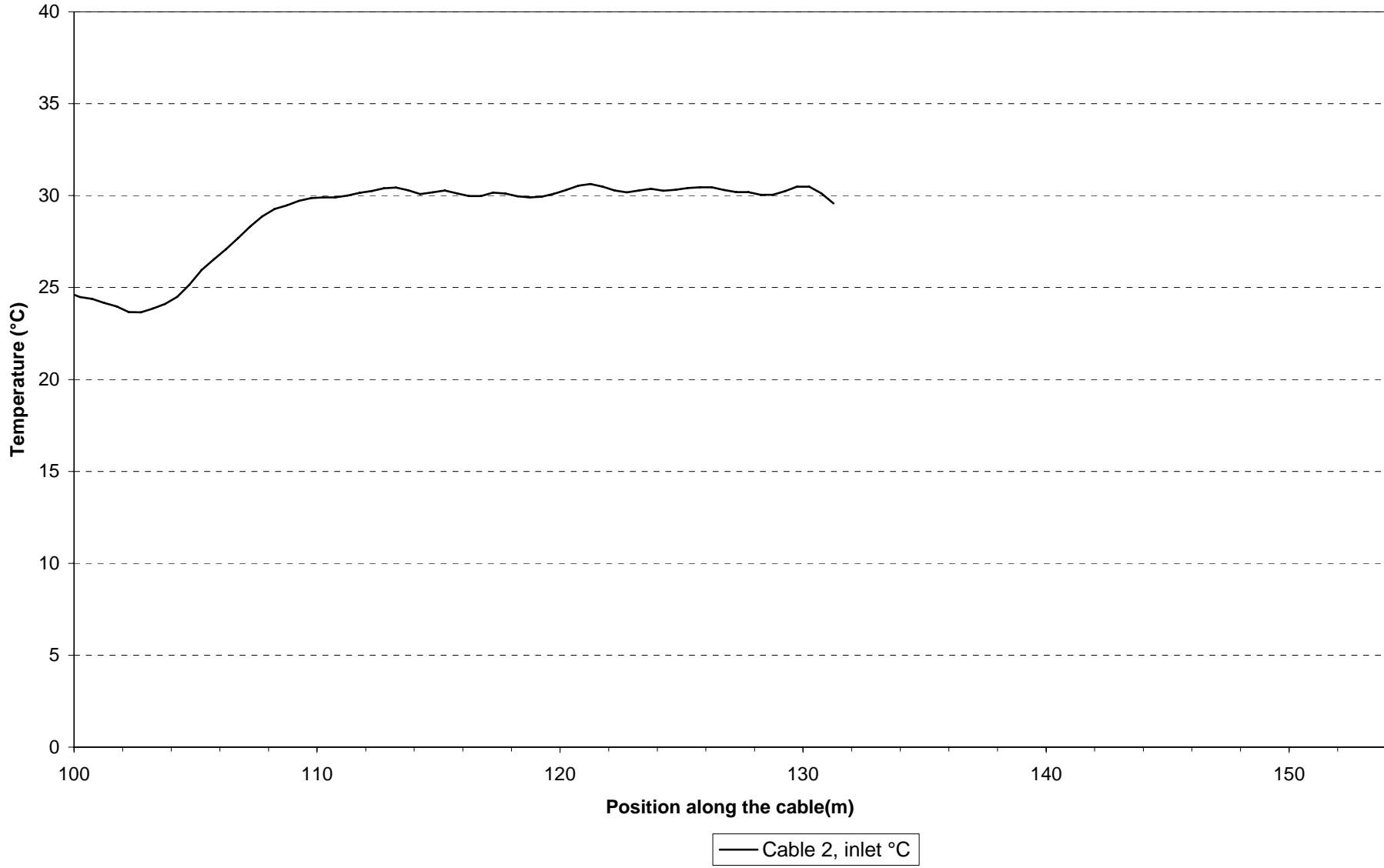
Prototype\ Hole 2 (010917-060601)  
Canister power



Prototype\ Hole 2 \Canister (010917-060601)  
 Max. temperature on the canister surface - Optical fiber cables

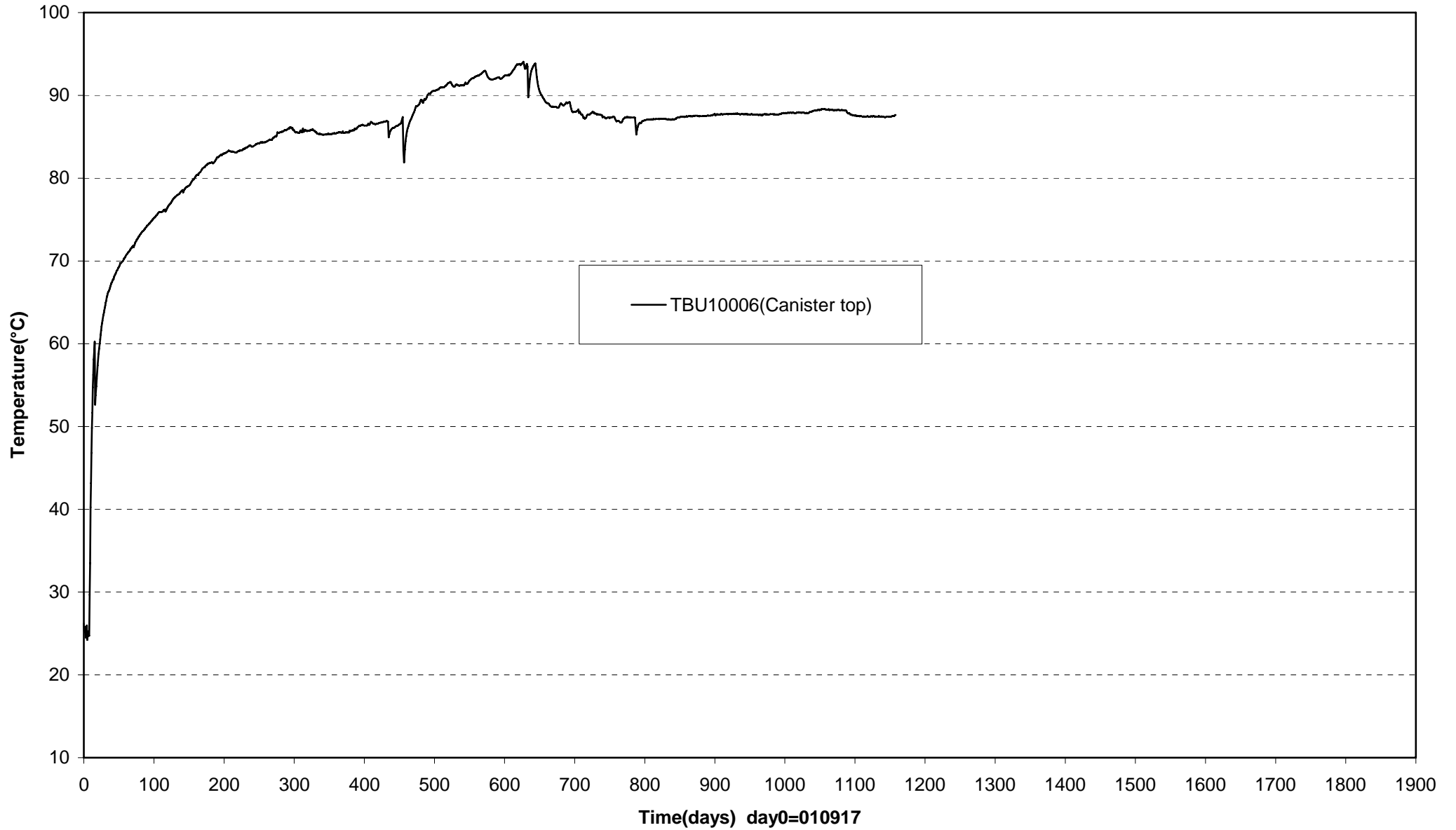


Prototype\ Hole 2 \Canister (050601)  
Temperature profile on the canister surface - Optical fiber cables

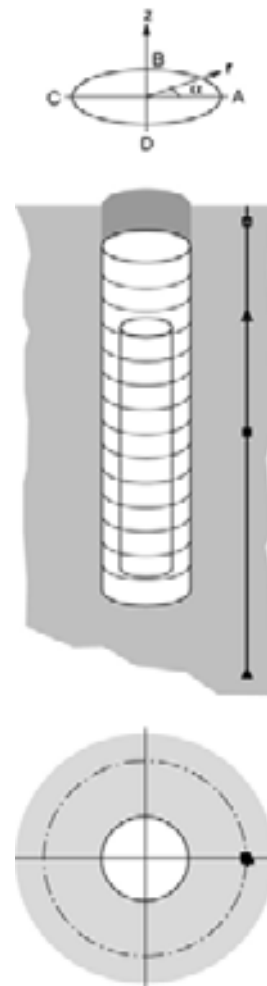
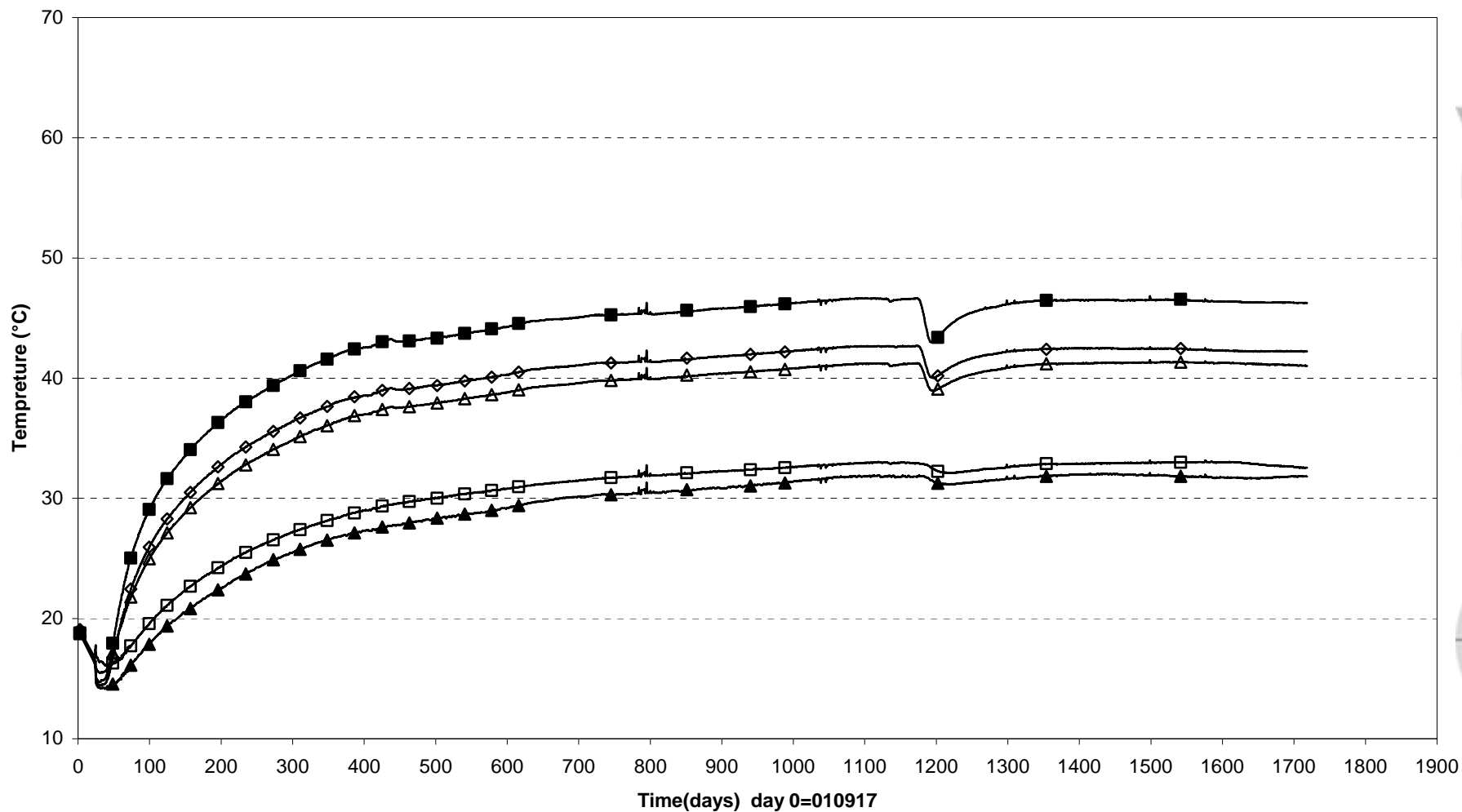




Prototype\Hole 2 \Canister top (010917-060601)  
Temperature - Pentronic

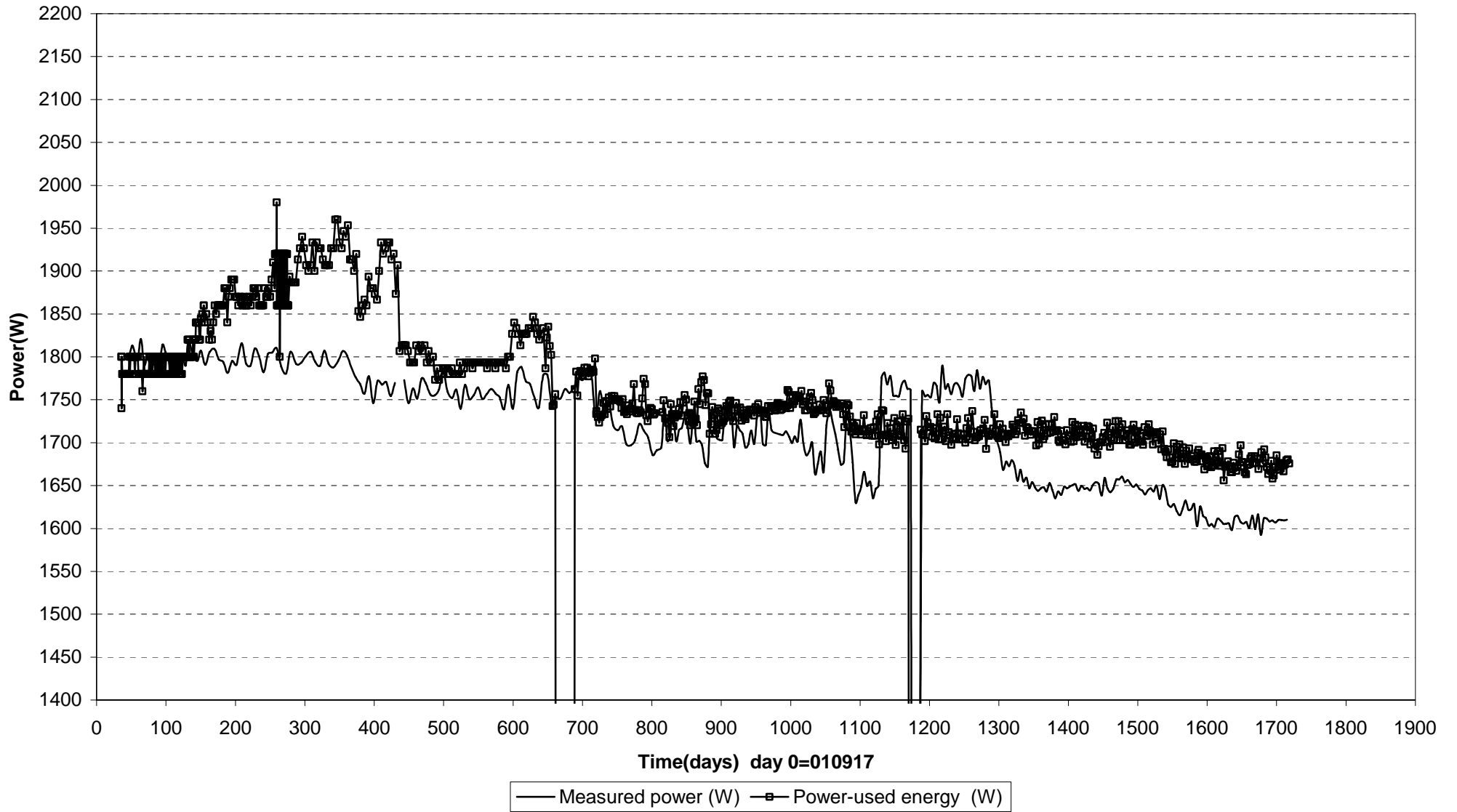


Prototype\Rock\Hole 4 (010917-060601)  
 Temperature - Pentronic

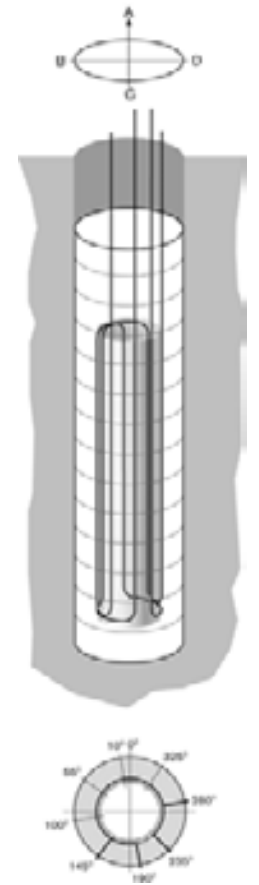
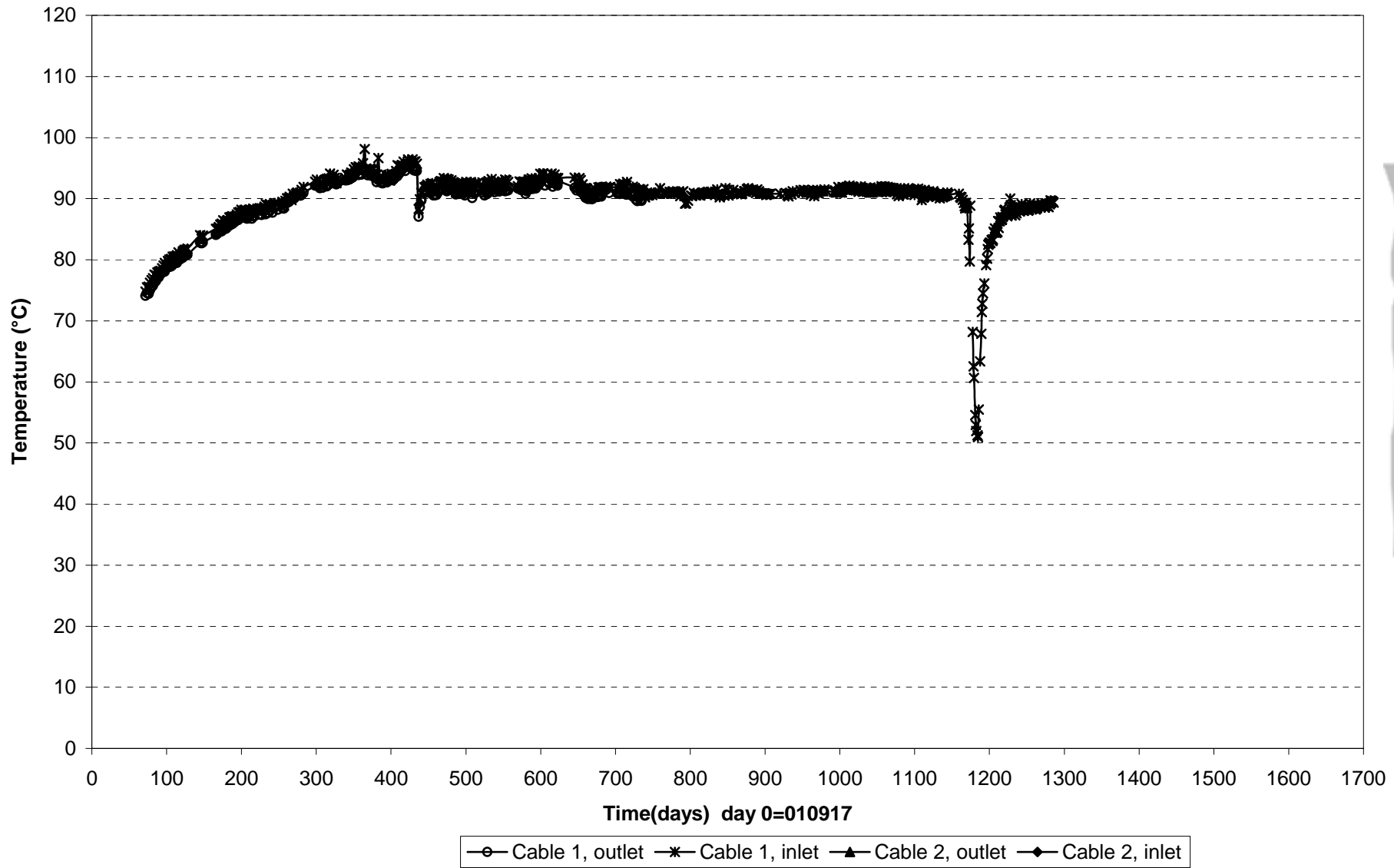


□ TROA3050 (7.671\360°\2.017)	△ TROA3040 (5.671\359°\2.025)	■ TROA3030(3.271\358°\2.034)
◇ TROA3020(0.871\358°\2.045)	▲ TROA3010(-1.778\357°\2.056)	

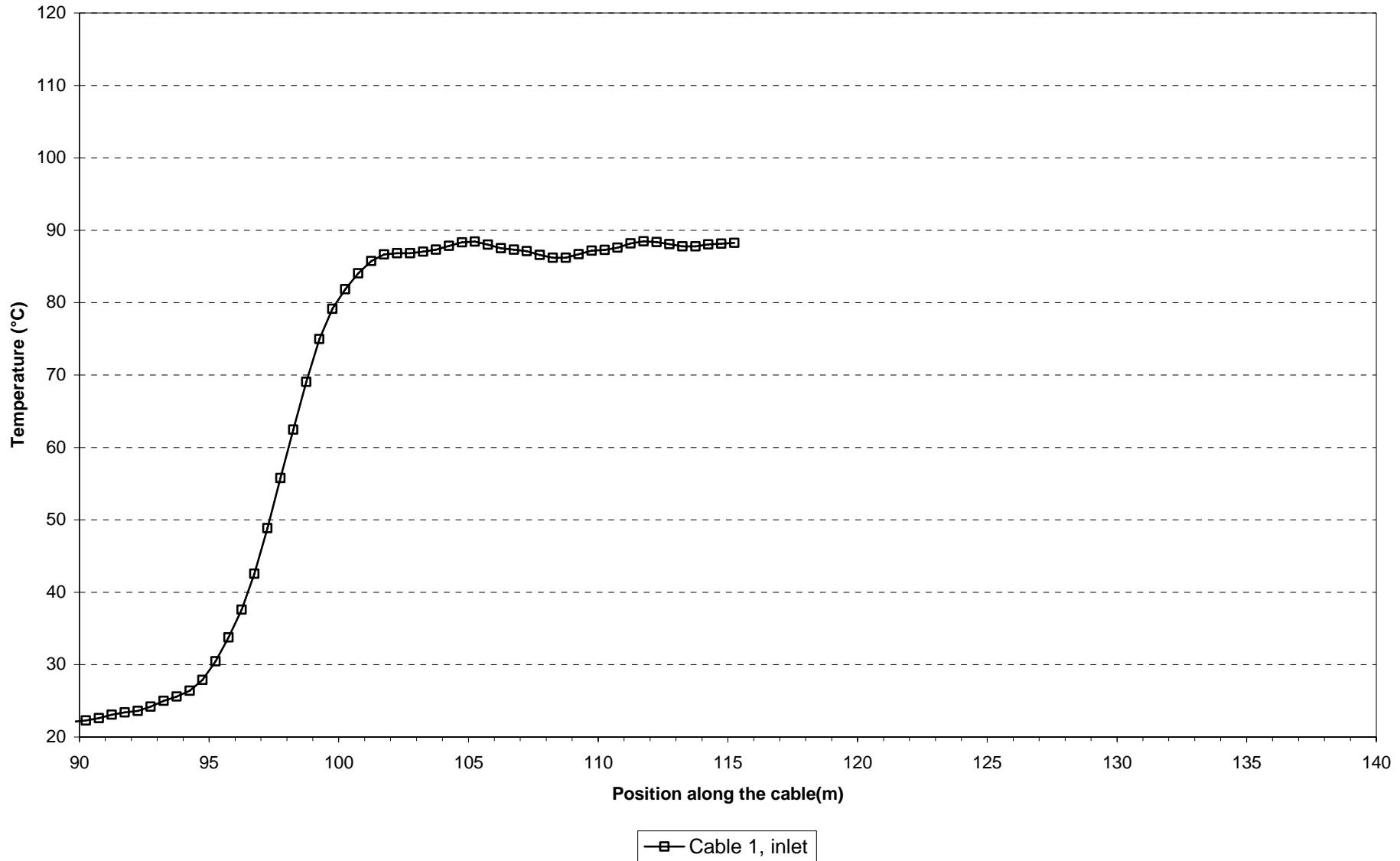
Prototype\Hole 4 (010917-060601)  
Canister power



Prototype\ Hole 4 \Canister (010917-060601)  
 Max. temperature on the canister surface - Optical fiber cables



Prototype\ Hole 4\Canister (041130)  
Temperature profile on the canister surface - Optical fiber cables





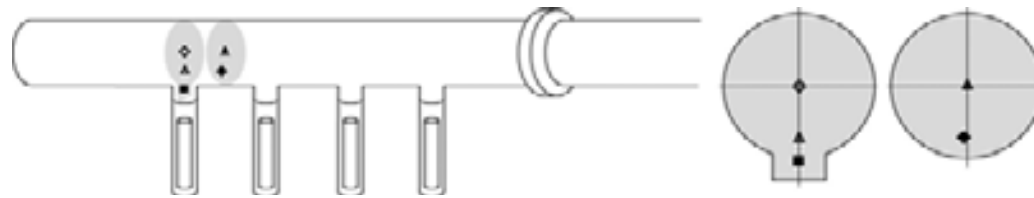
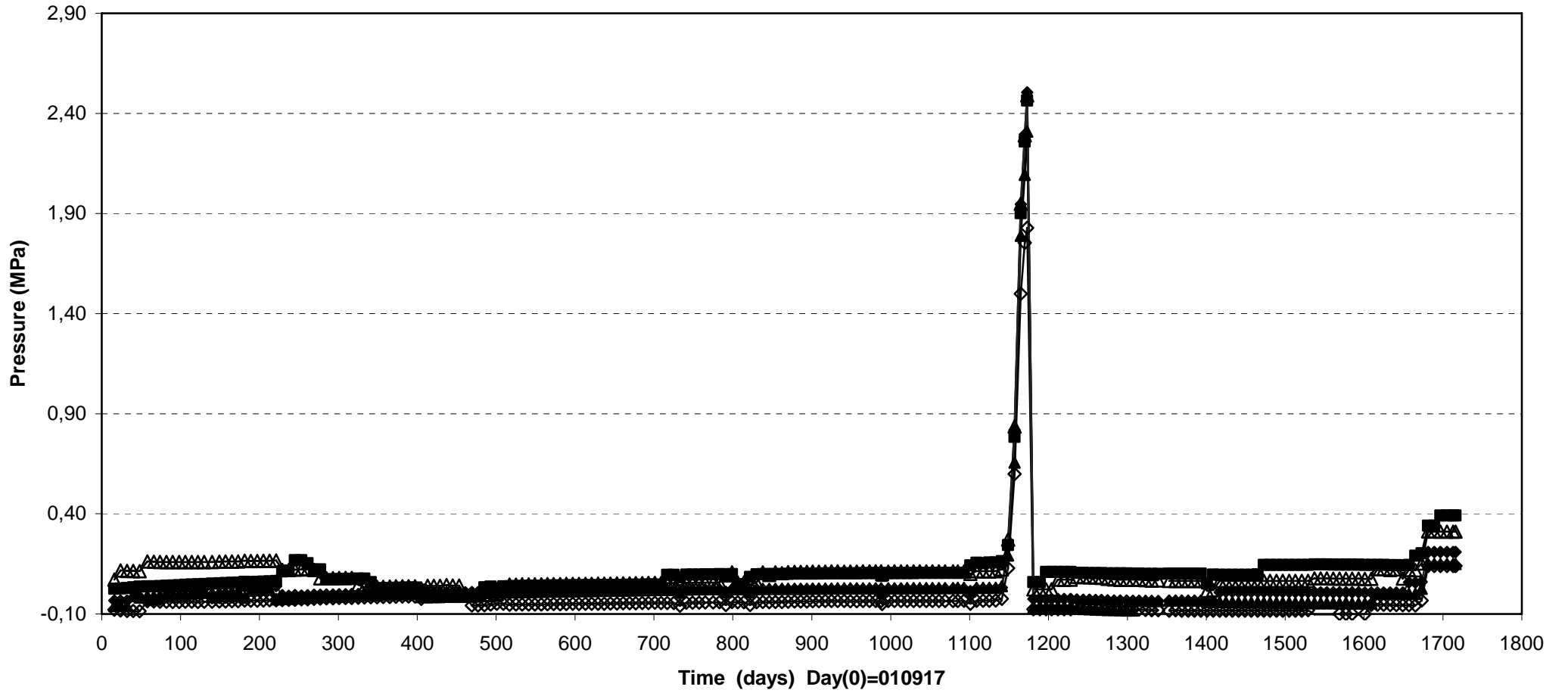
## **Appendix 4**

### **Backfill in section 1**



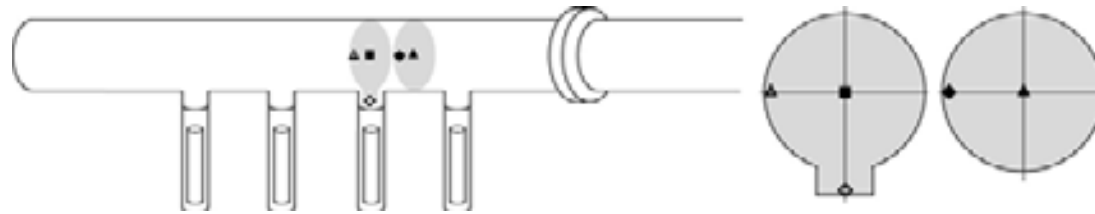
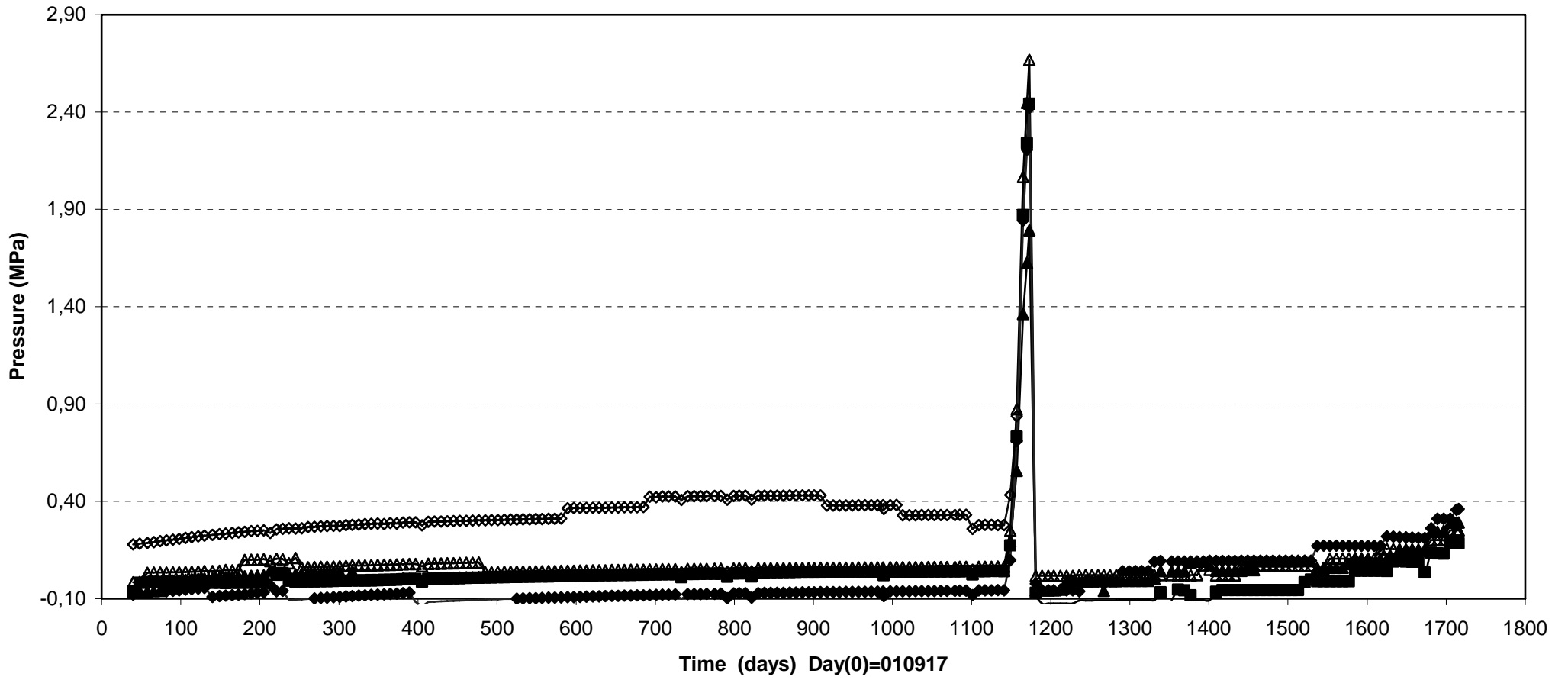


Prototype\Backfill\Section 1 (010917-060601)  
 Total pressure - Geokon



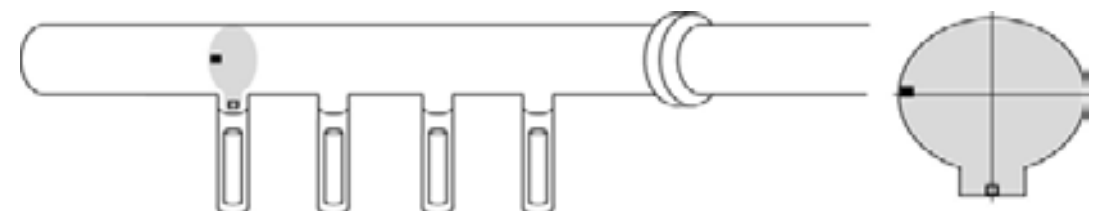
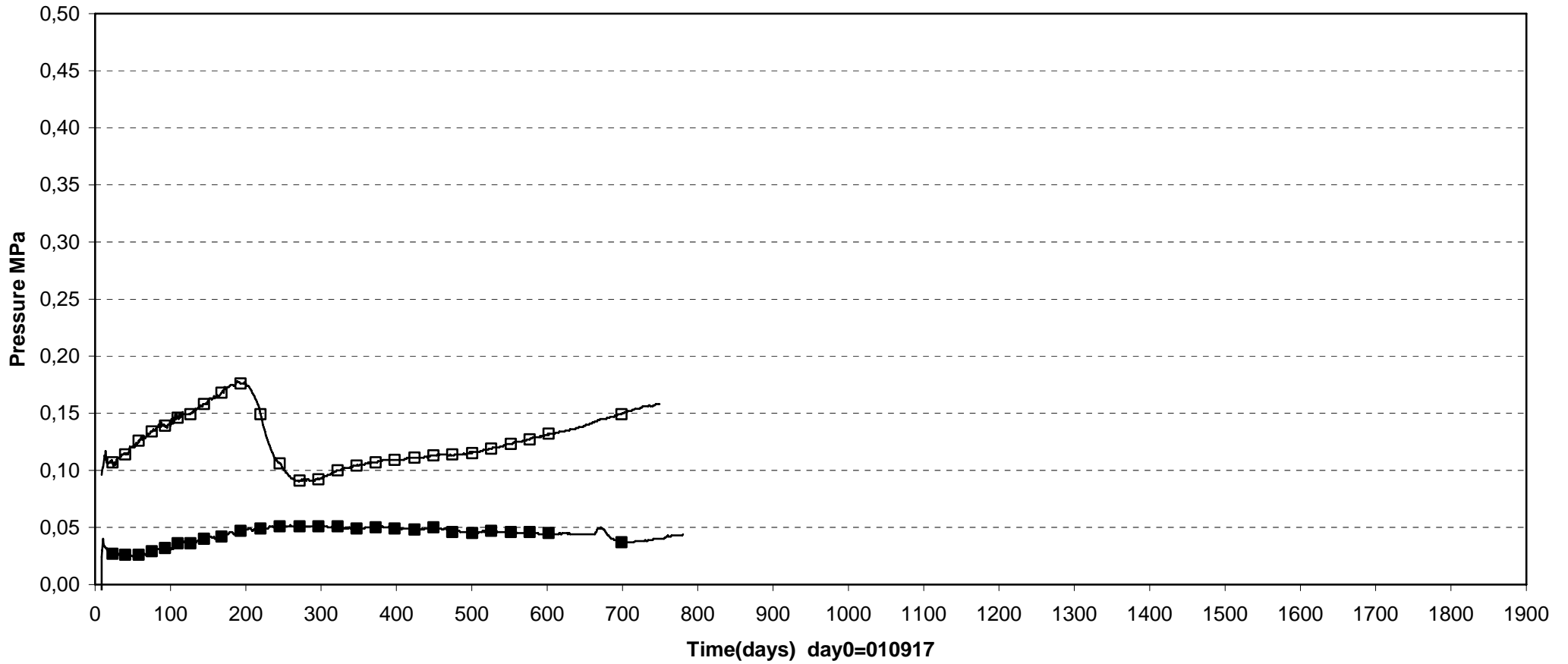
◇ PBA10002(E1\0\0\3587)  
 ▲ PBA10003(E1\0 \-1,8\3587)  
 ■ PBA10004(E1\0 \-2,6\3587)  
 ▲ PBA10008(F1-2\0\0\3584)  
 ◆ PBA10009(F1-2\0.1\1,8\3584)

Prototype\Backfill\ Section 1 (010917-060601)  
 Total pressure - Geokon



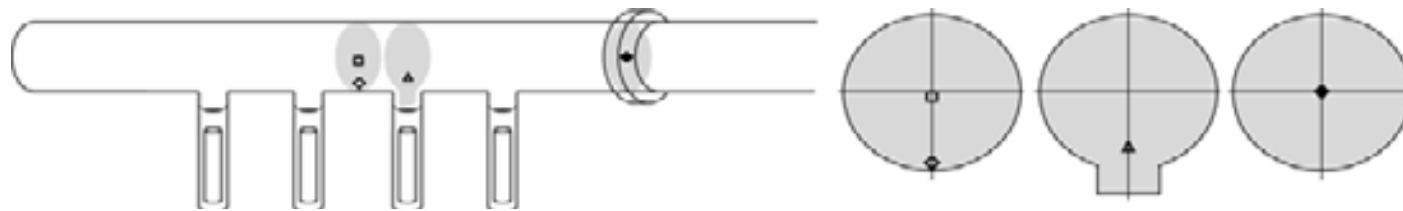
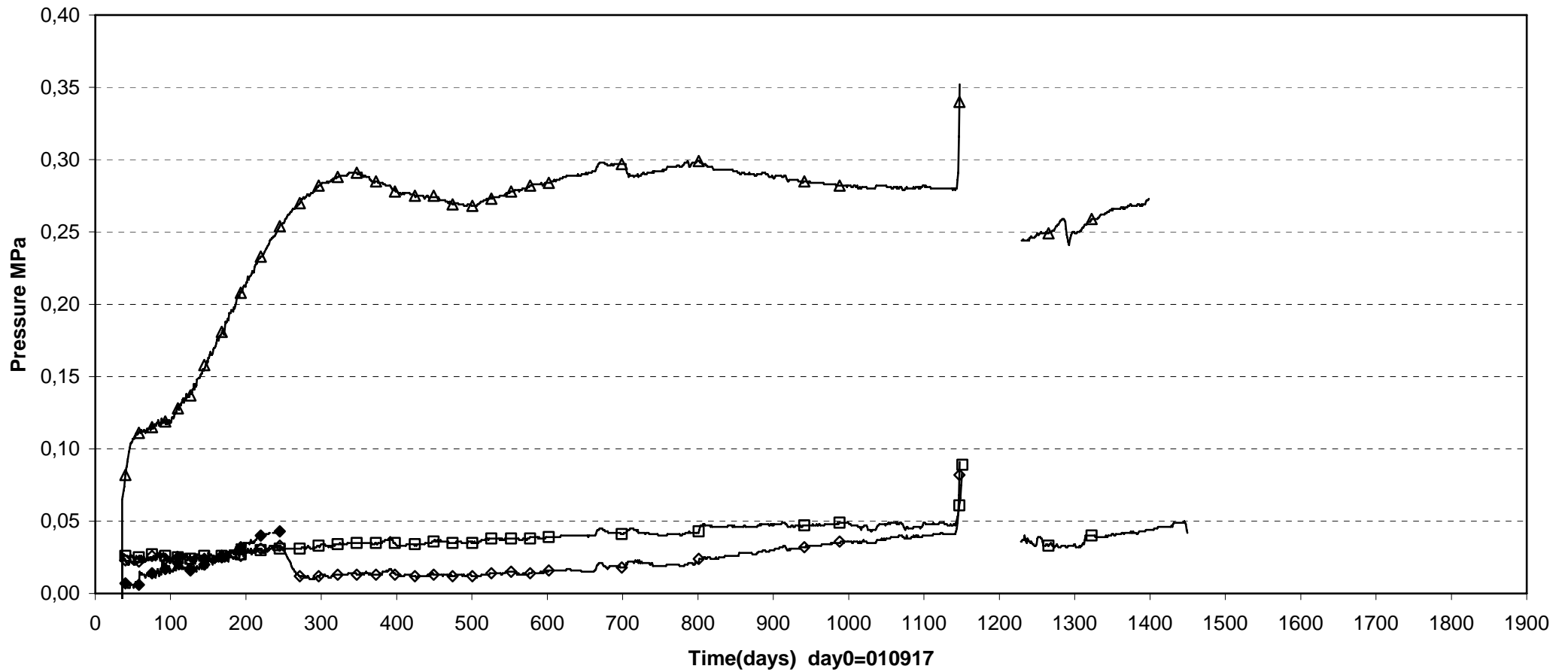
◆ PBA10015(E3\0\3.1\3575)
▲ PBA10016(E3\2.3\0\3575)
■ PBA10017(E3\0\0\3574)
▲ PBA10018(F3-4\0\0\3572)
◆ PBA10019(F3-4\0\2.3\3572)

Prototype\Backfill\Section 1 (010917-060601)  
Total pressure - Kulite



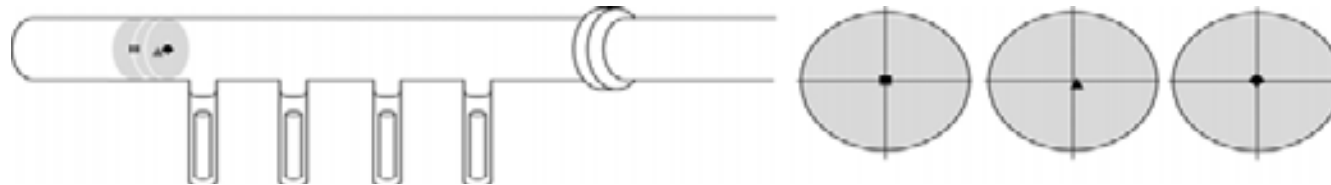
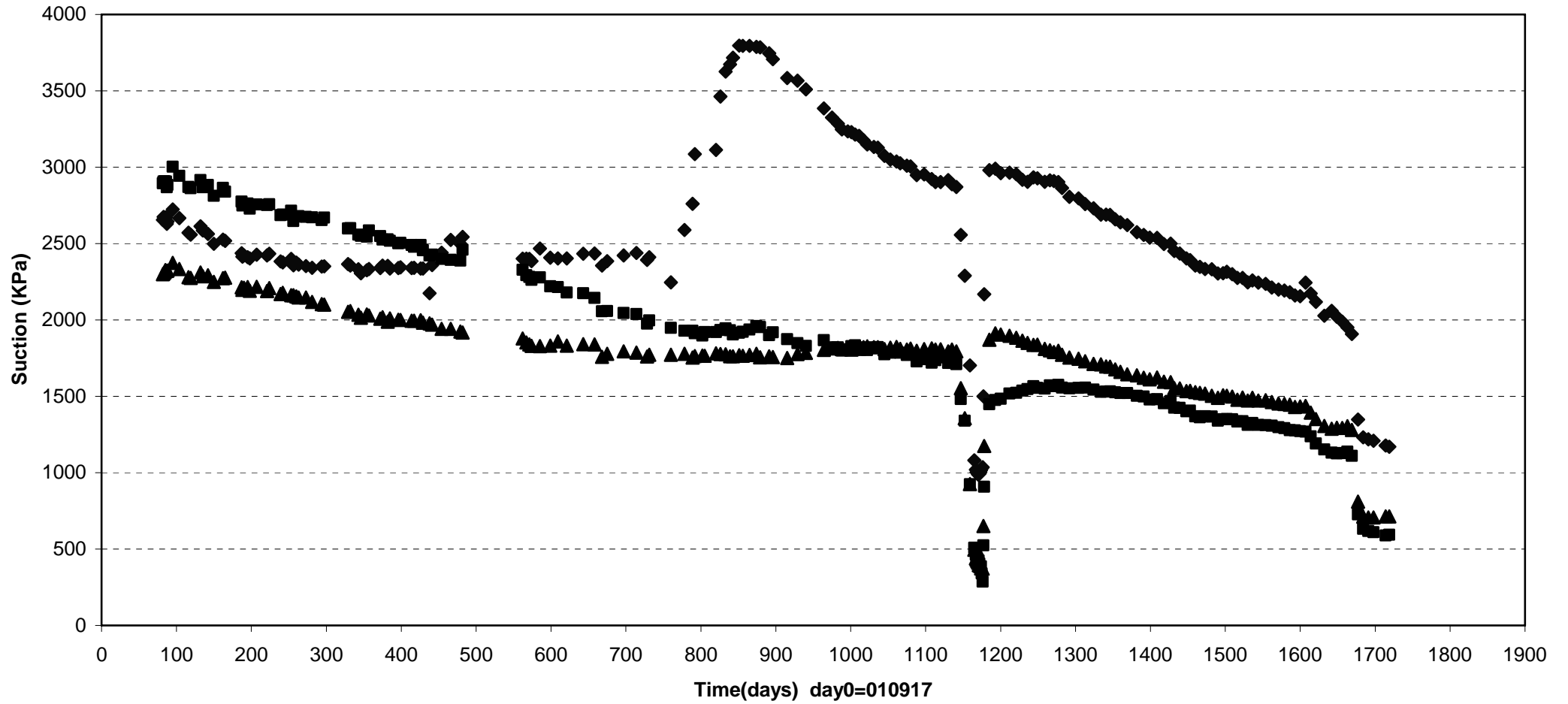
□ PBA10005(E1\0\3.1\3587) ■ PBA10006(E1\2.3\0.1\3587)

Prototype\Backfill\Section 1 (041015-060601)  
 Total pressure - Kulite



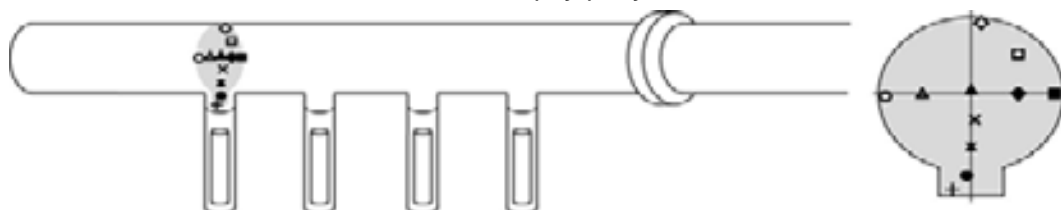
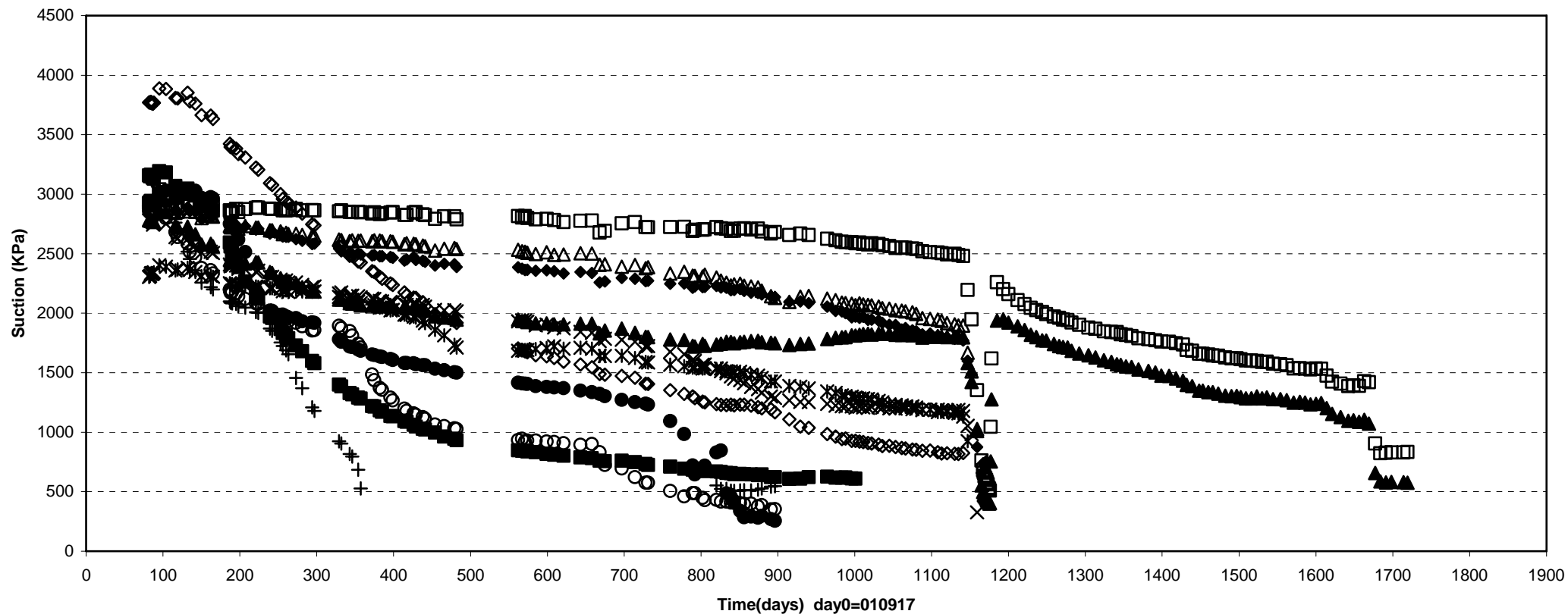
□ PBA10010(F1-2\0-0.2\3578) ◇ PBA10011(F1-2\0-2.3\3578) △ PBA10013(E3\0-1.82\3575) ◆ PBA10020(In front of plug\0\0\3561)

Prototype\Backfill \ Inner part (010917-060601)  
Suction - Wescor



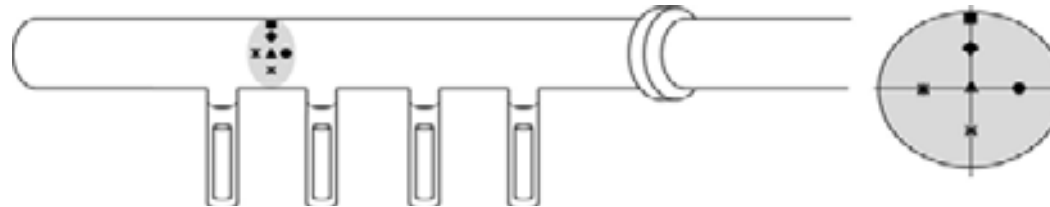
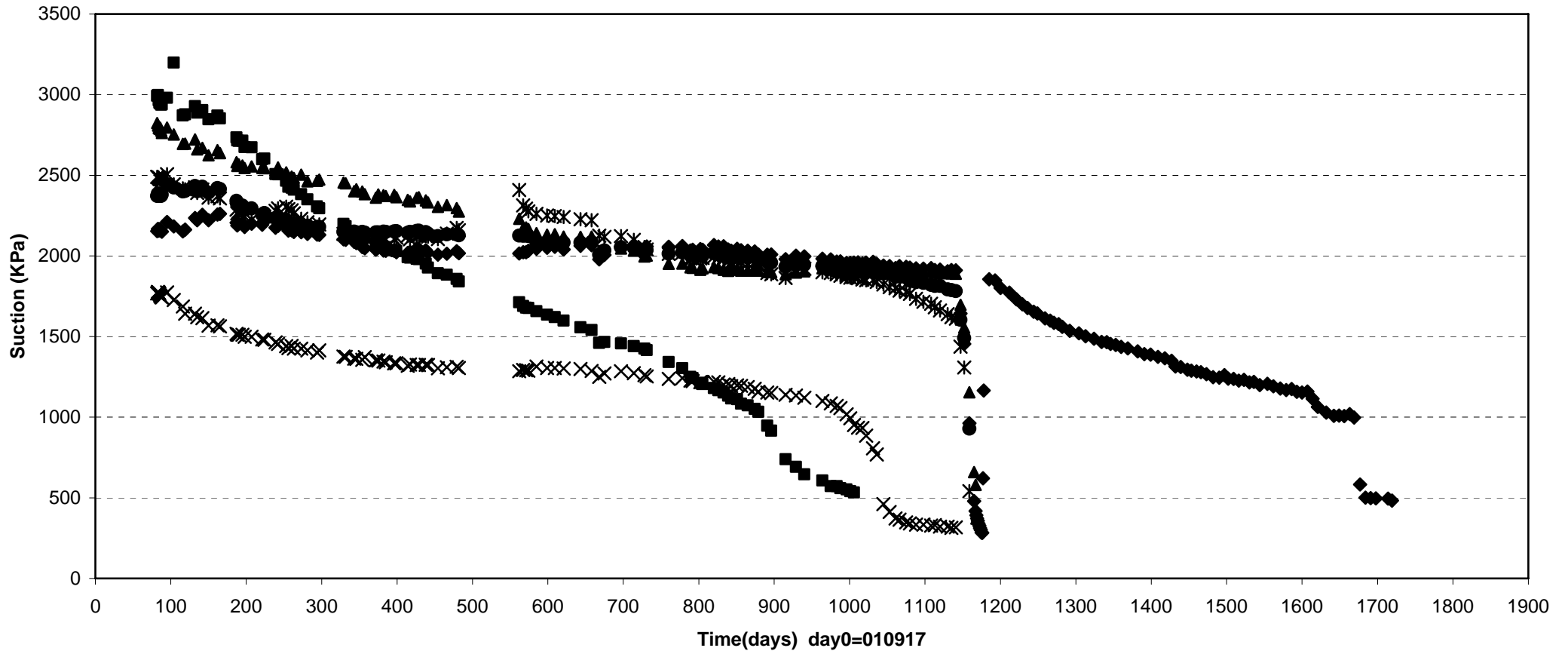
◆ WBA10001 (Inner part\0\0\3589) ■ WBA10002 (Inner part\0\0\3592) ▲ WBA10003 (Inner part\0.1\0.1\3590)

Prototype\Backfill\ Above dep.hole 1 (010917-060601)  
Suction - Wescor



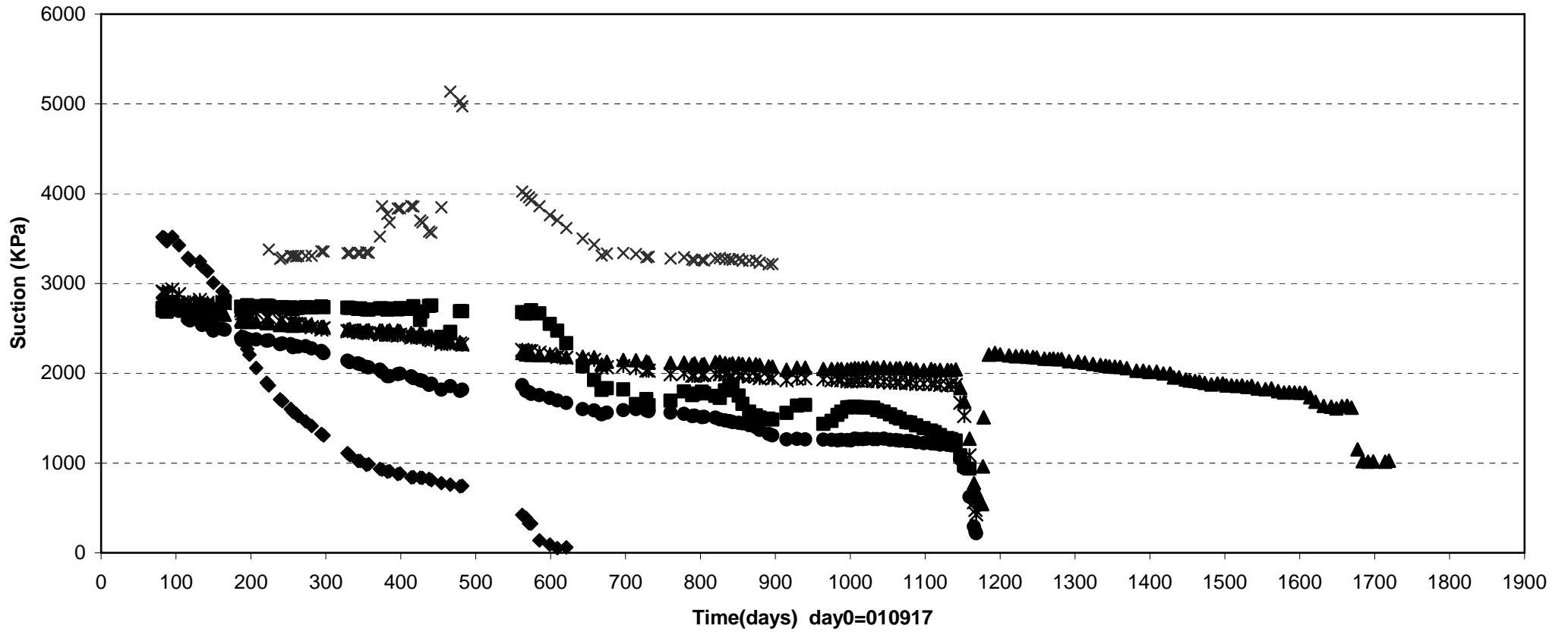
◇ WBA10004(E1\0.25\2.3\3587)	□ WBA10005(E1\0\1.25\3587)	▲ WBA10006(E1\0\0.1\3587)	× WBA10007(E1\0.1\ -0.8\3587)
× WBA10008(E1\0\ -1.7\3587)	● WBA10009(E1\ -0.1\ -2.6\3587)	+ WBA10010(E1\ -0.5\ -3.13\3587)	○ WBA10011(E1\ -2.3\ -0.1\3587)
△ WBA10012(E1\ -1.3\0\3587)	◆ WBA10013(E1\1.3\0\3587)	■ WBA10014(E1\2.3\0\3587)	

Prototype\Backfill \ Between dep.hole 1 and hole 2 (010917-060601)  
 Suction - Wescor



- ◆ WBA10015(F1-2\0\1.3\3584)    ■ WBA10016(F1-2\0\2.3\3584)    ▲ WBA10017(F1-2\0\0\3584)    × WBA10018(F1-2\0\1.3\3584)
- × WBA10019(F1-2\1.3\0\3584)    ● WBA10020(F1-2\1.3\0\3584)

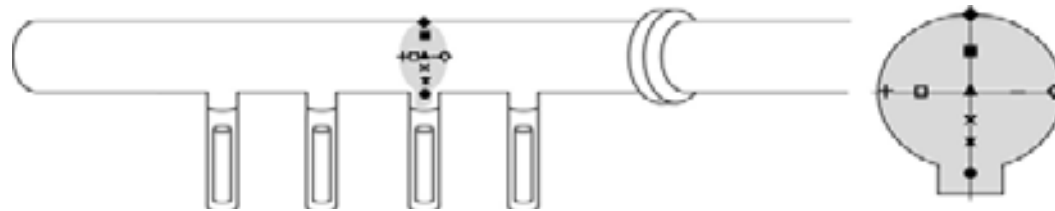
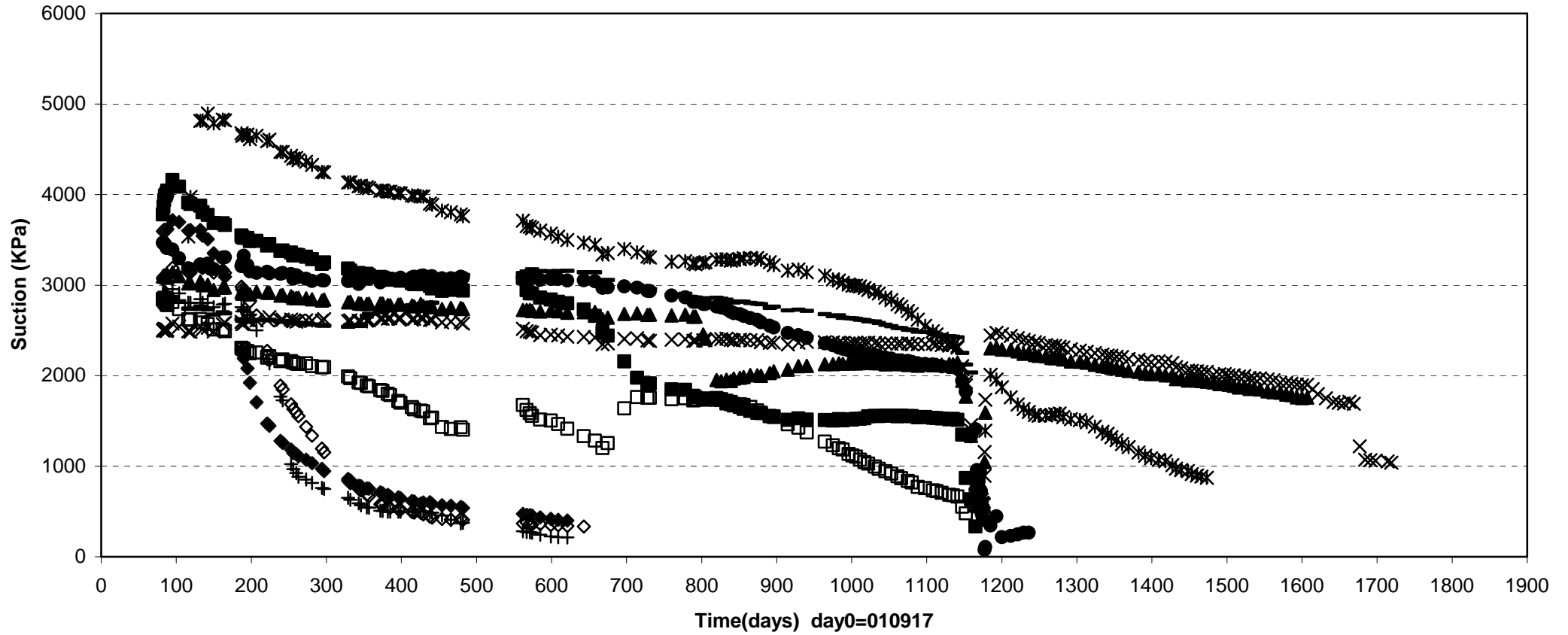
Prototype\Backfill \ Between dep.hole 2 and hole 3 (010917-060601)  
 Suction - Wescor



- ◆ WBA10021(F2-3\0\2.3\3578)    ■ WBA10022(F2-3\0\1.2\3578)    ▲ WBA10023(F2-3\0\0.2\3578)    ✖ WBA10025(F2-3\1.3\0\3578)
- WBA10026(F2-3\1.3\0\3578)    × WBA10024(F2-3\0\1.2\3578)

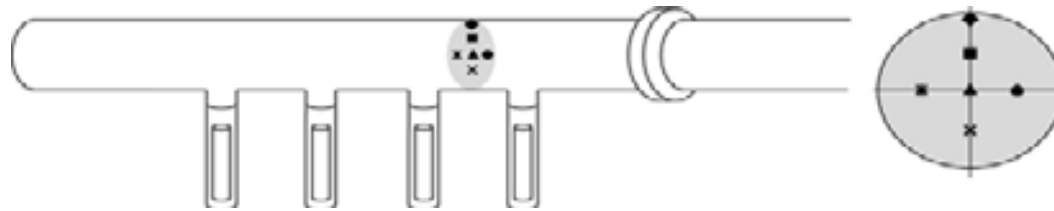
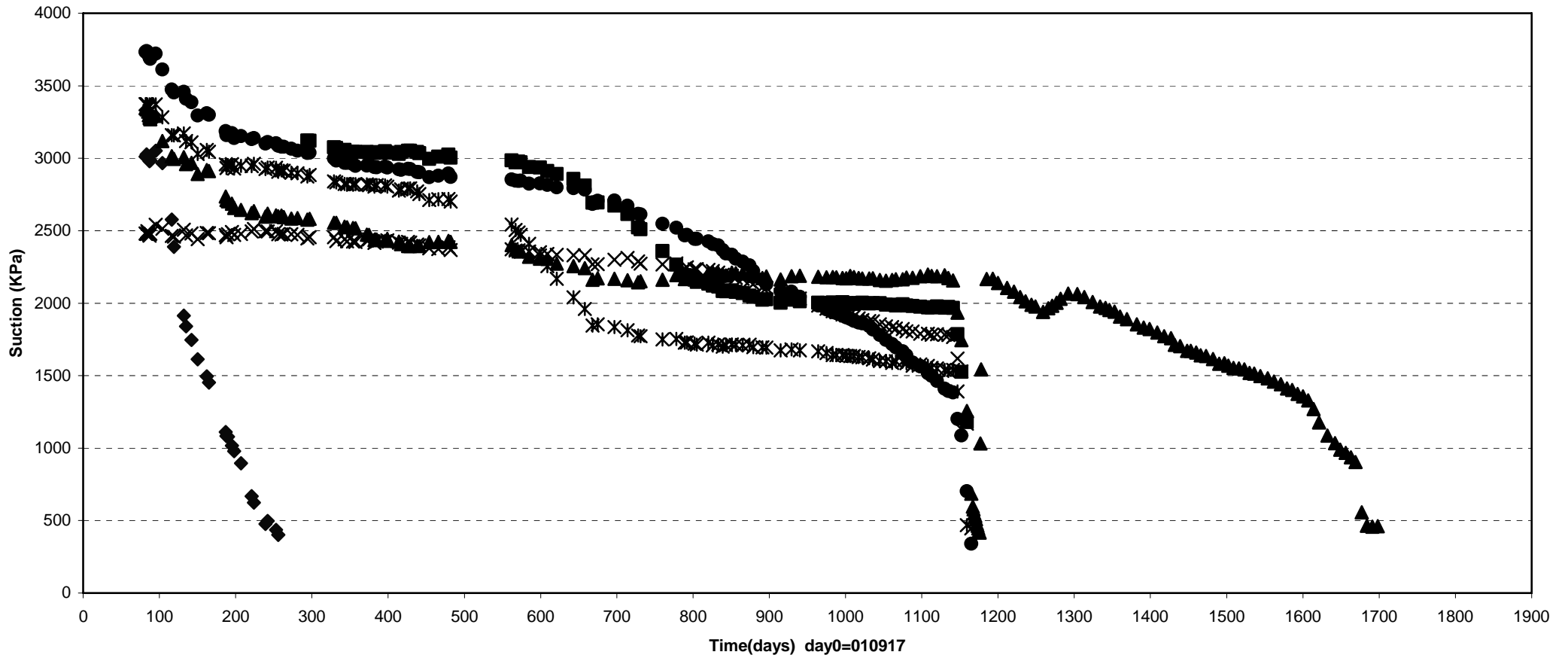


Prototype\Backfill\ Above dep.hole 3 (010917-060601)  
Suction - Wescor



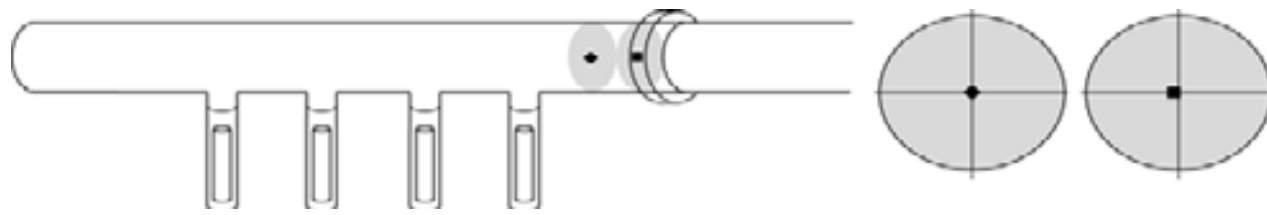
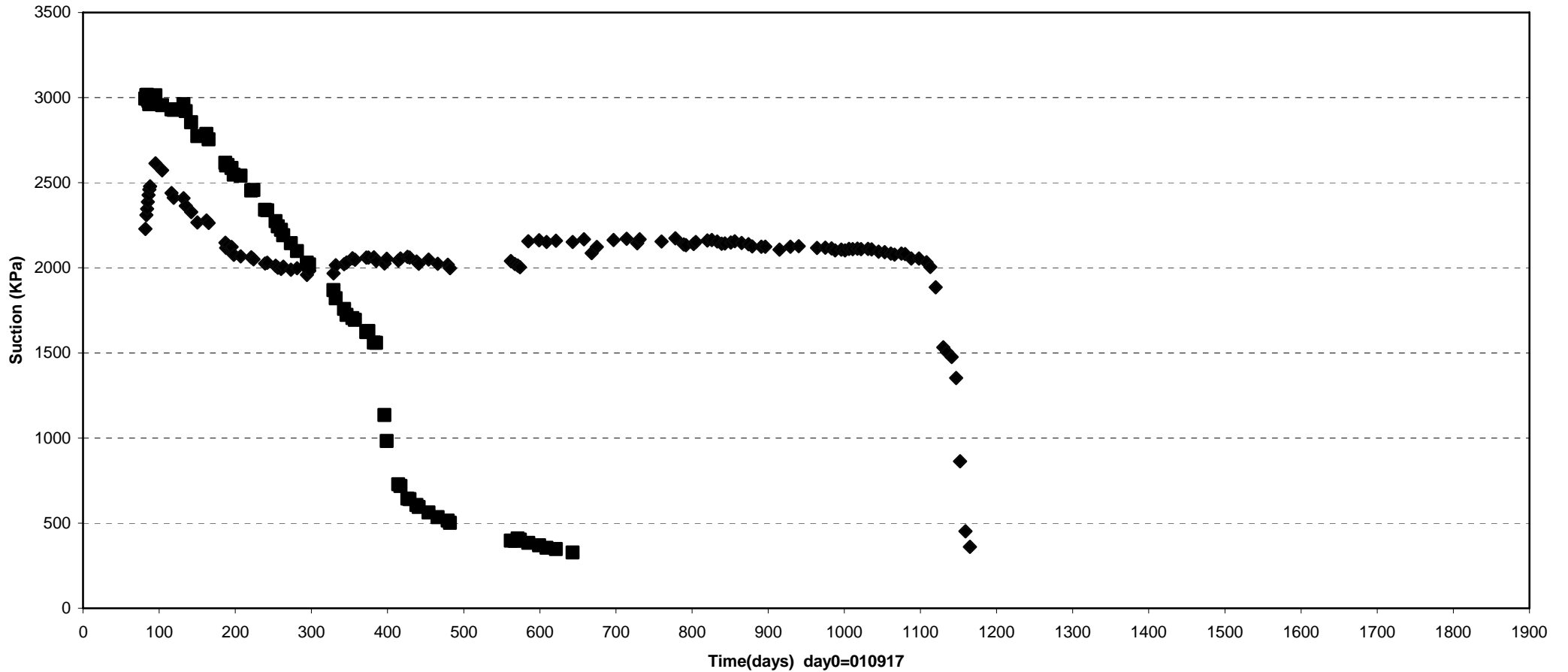
- |                               |                           |                           |                           |                           |
|-------------------------------|---------------------------|---------------------------|---------------------------|---------------------------|
| ◆ WBA10027(E3\0\2.5\3574)     | ■ WBA10028(E3\0\1.3\3575) | ▲ WBA10029(E3\0\0\3575)   | × WBA10030(E3\0\0.9\3575) | ✱ WBA10031(E3\0\1.6\3575) |
| ● WBA10032(E3\0\0.3\2.6\3575) | + WBA10034(E3\2.3\0\3575) | □ WBA10035(E3\1.3\0\3575) | — WBA10036(E3\1.3\0\3575) | ◇ WBA10037(E3\2.3\0\3575) |

Prototype\Backfill \ Between dep.hole 3 and hole 4 (010917-060601)  
Suction - Wescor



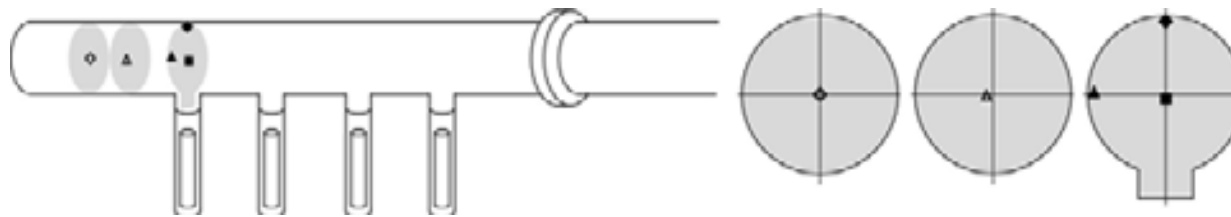
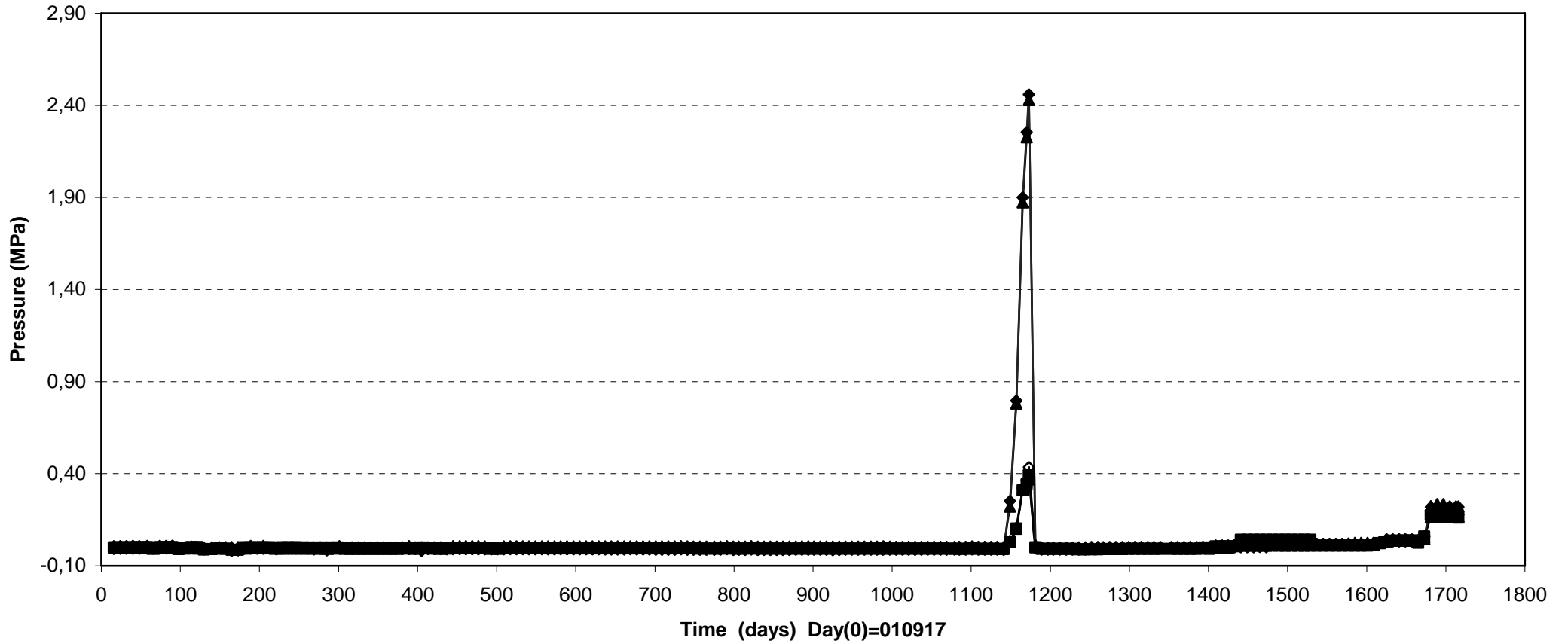
- ◆ WBA10038(F3- 4\0\2.3\3572)
- WBA10039(F3- 4\0\1.2\3572)
- ▲ WBA10040(F3- 4\0\0\3572)
- × WBA10041(F3- 4\0\1.3\3572)
- ✱ WBA10042(F3- 4\1.3\0\3572)
- WBA10043(F3- 4\1.3\0\3572)

Prototype\Backfill \ In front of plug (010917-060601)  
Suction - Wescor



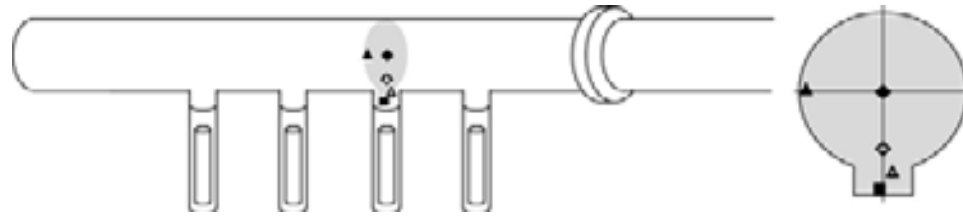
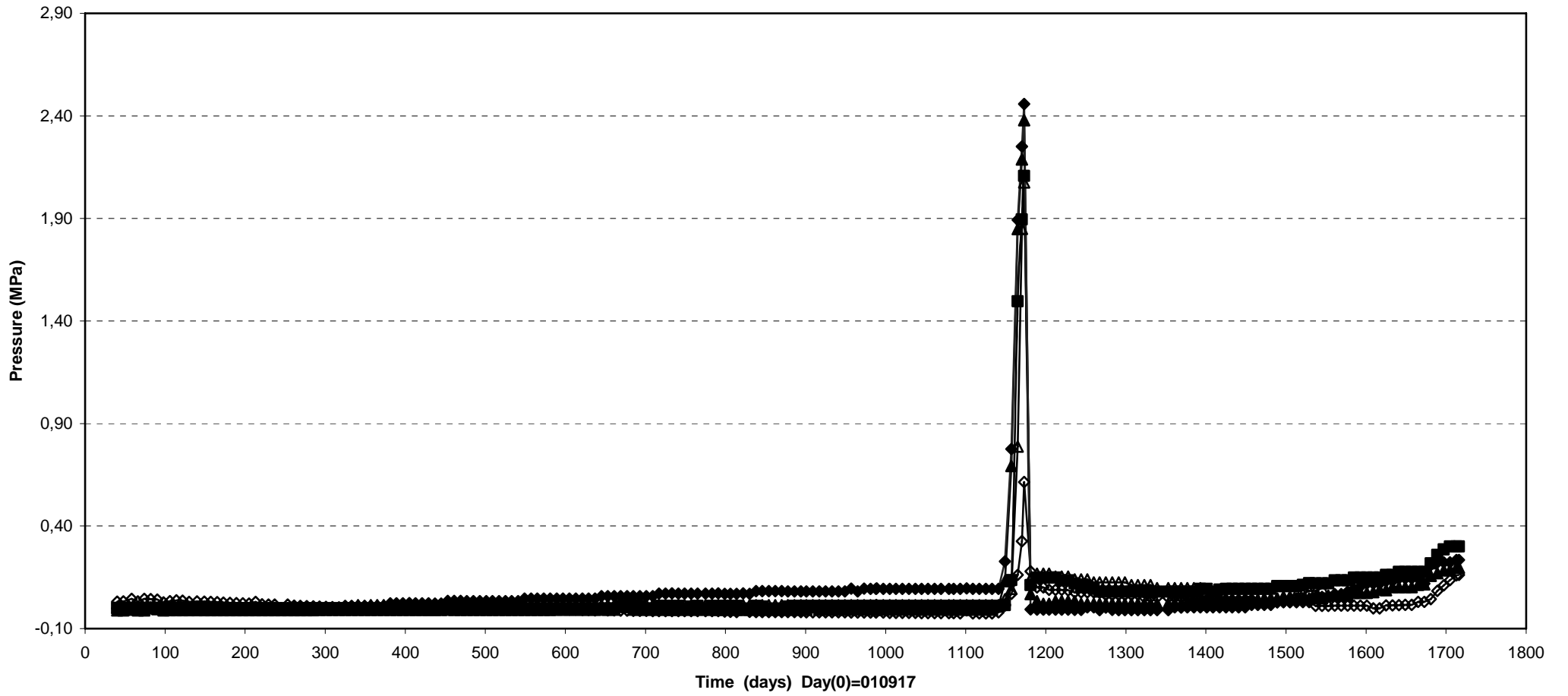
◆ WBA10044(In front of plug\0\0\3565) ■ WBA10045(In front of plug\0.1\0\3562)

Prototype\Backfill\Section 1 (010917-060601)  
 Pore pressure - Geokon



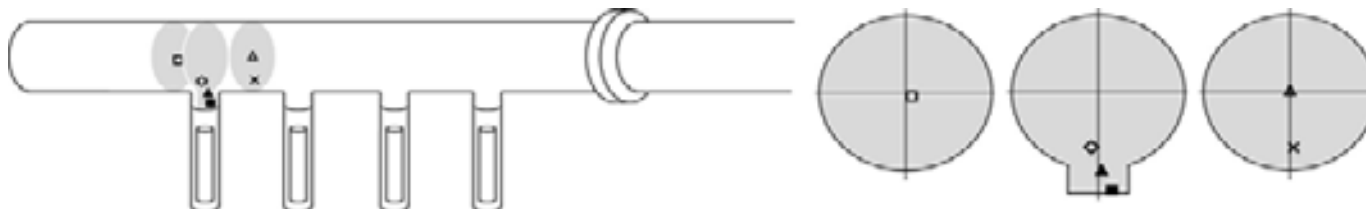
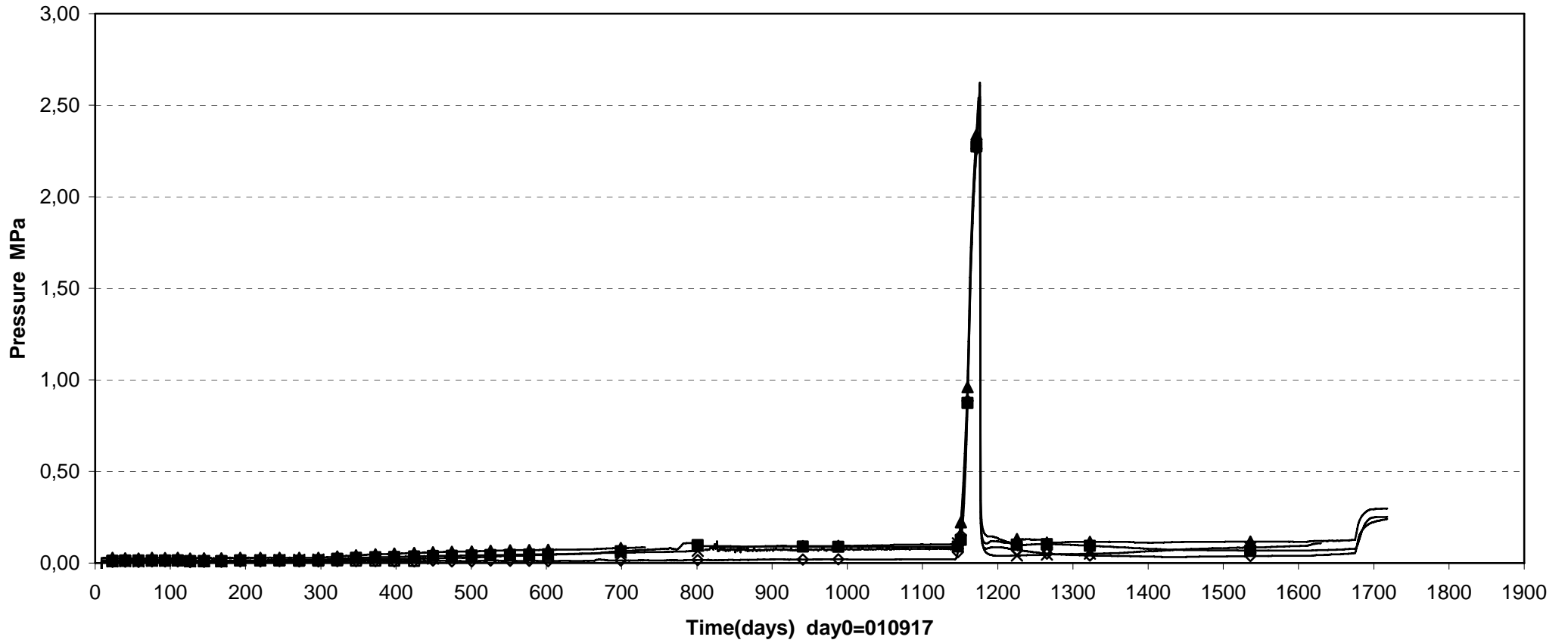
- ◇— UBA10002 (Inner part\0\0\3592)
- ▲— UBA10003 (Inner part\ -0.2\ -0.1\3590)
- UBA10004 (E1\0\0\3587)
- ◆— UBA10009 (E1\0\2.3\3587)

Prototype\Backfill \ Section 1 (010917-060601)  
 Pore pressure - Geokon



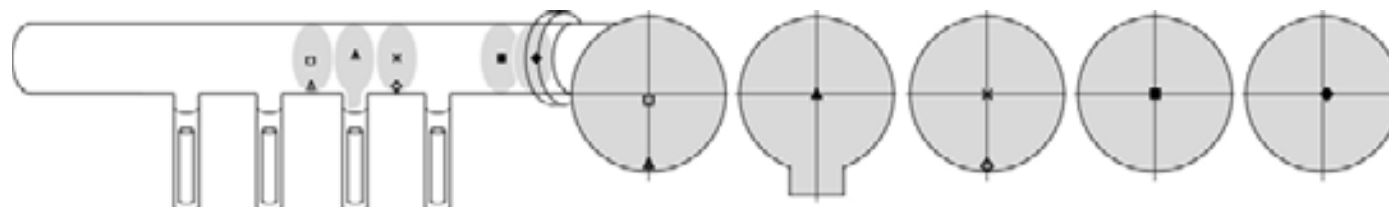
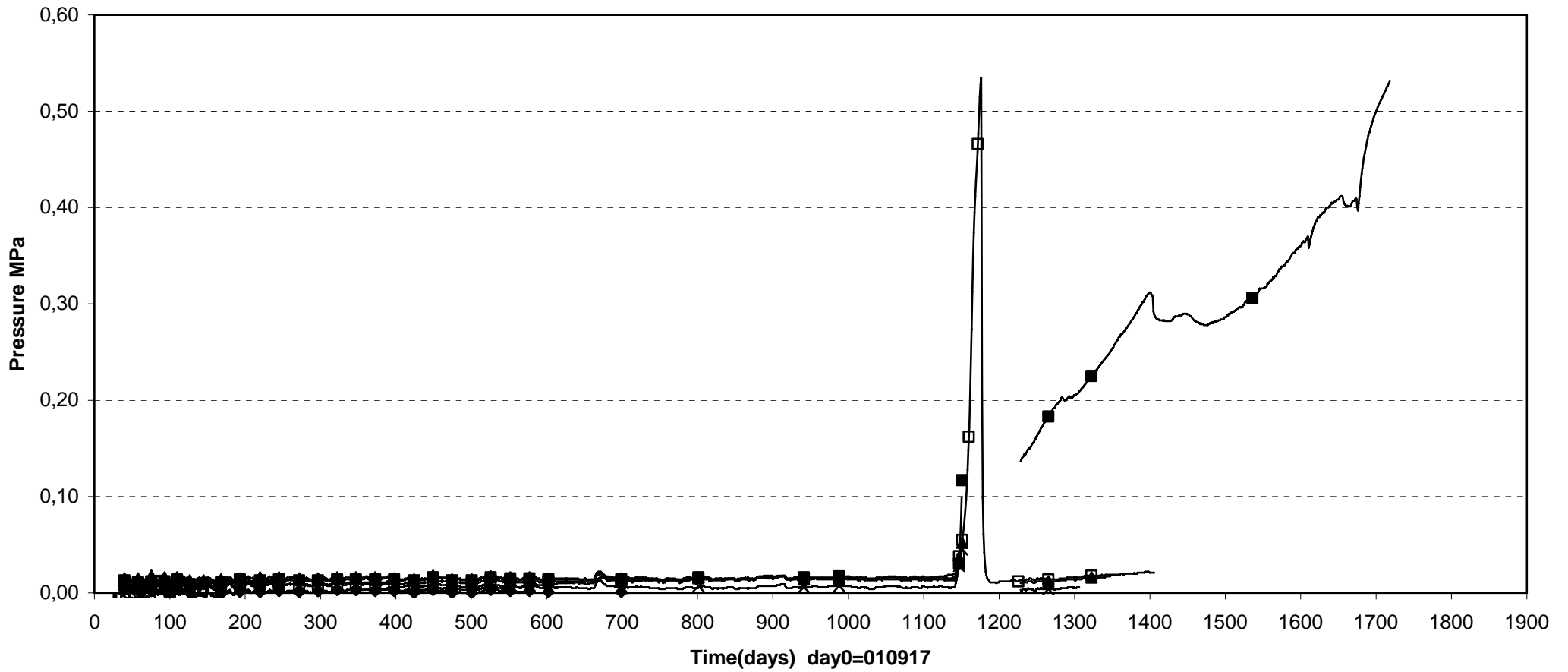
◇ UBA10015(E3\0\ -1.82\3575)   
 ▲ UBA10016(E3\0.25\ -2.6\3575)   
 ■ UBA10017(E3\ -0.1\ -3.1\3575)   
 ▲ UBA10018(E3\ -2.3\0\3575)   
 ◆ UBA10019(E3\0\0\3574)

**Prototype\Backfill\ Section 1 (010917-060601)**  
**Pore pressure - Kulite**



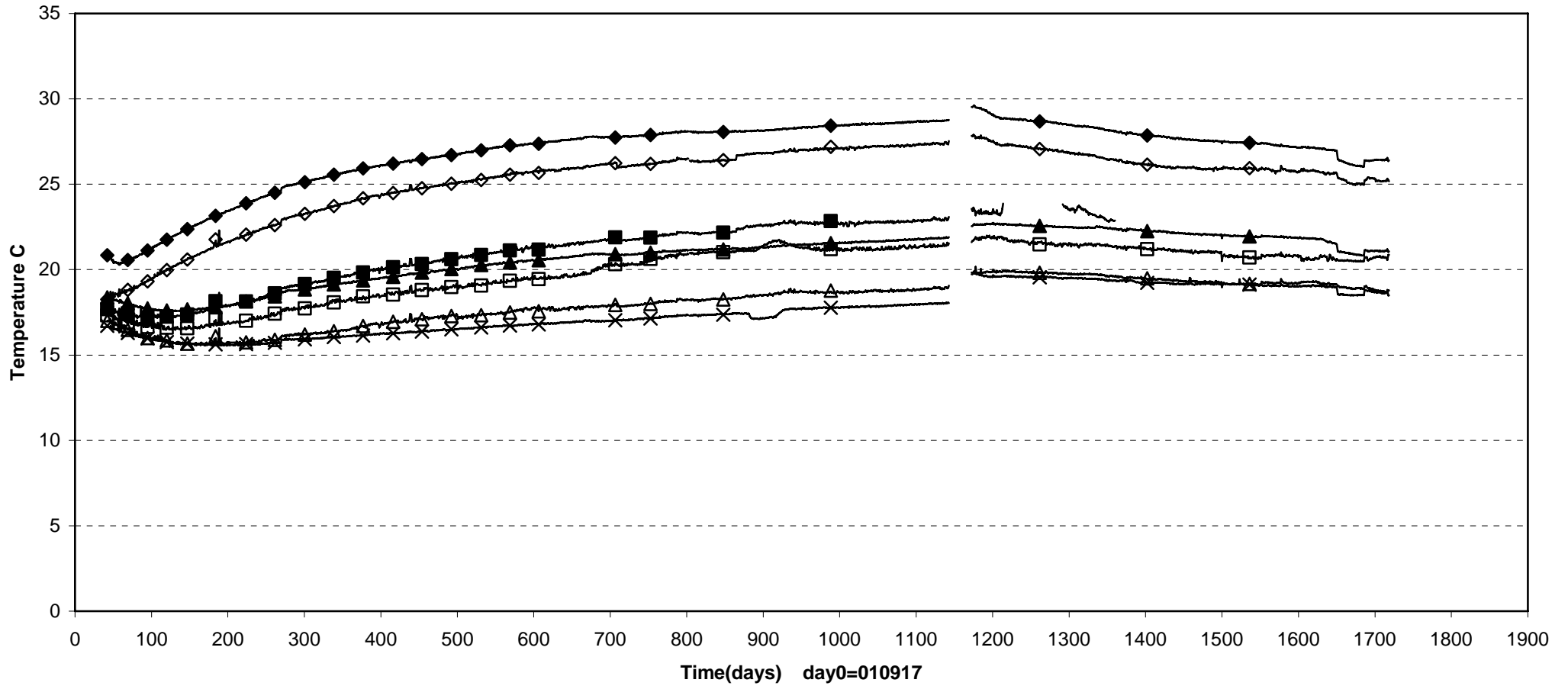
□ UBA10001 (Inner part\0.2\0.1\3589)	◇ UBA10005 (E1\0.2\1.8\3587)	▲ UBA10006 (E1\0.1\2.6\3587)
■ UBA10007 (E1\0.4\3.2\3587)	△ UBA10010 (F1-2\0\3584)	× UBA10011 (F1-2\0.1\1.2\3584)

Prototype\Backfill \Section 1 (041015-060601)  
Pore pressure - Kulite



- |                               |                                       |   |                           |
|-------------------------------|---------------------------------------|---|---------------------------|
| □ UBA10012(F2-3\0\ -0.2\3578) | △ UBA10013(F2-3\0\ -2.3\3578)         | ▲ UBA10014(E3\0\0\3575)                 | × UBA10020(F3-4\0\0\3572) |
| ◇ UBA10021(F3-4\0\ -2.3\3572) | ■ UBA10022(In front of plug\0\0\3565) | ◆ UBA10023(In front of plug\0.1\0\3561) |                           |

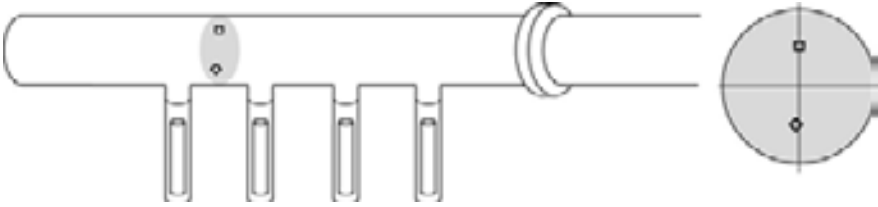
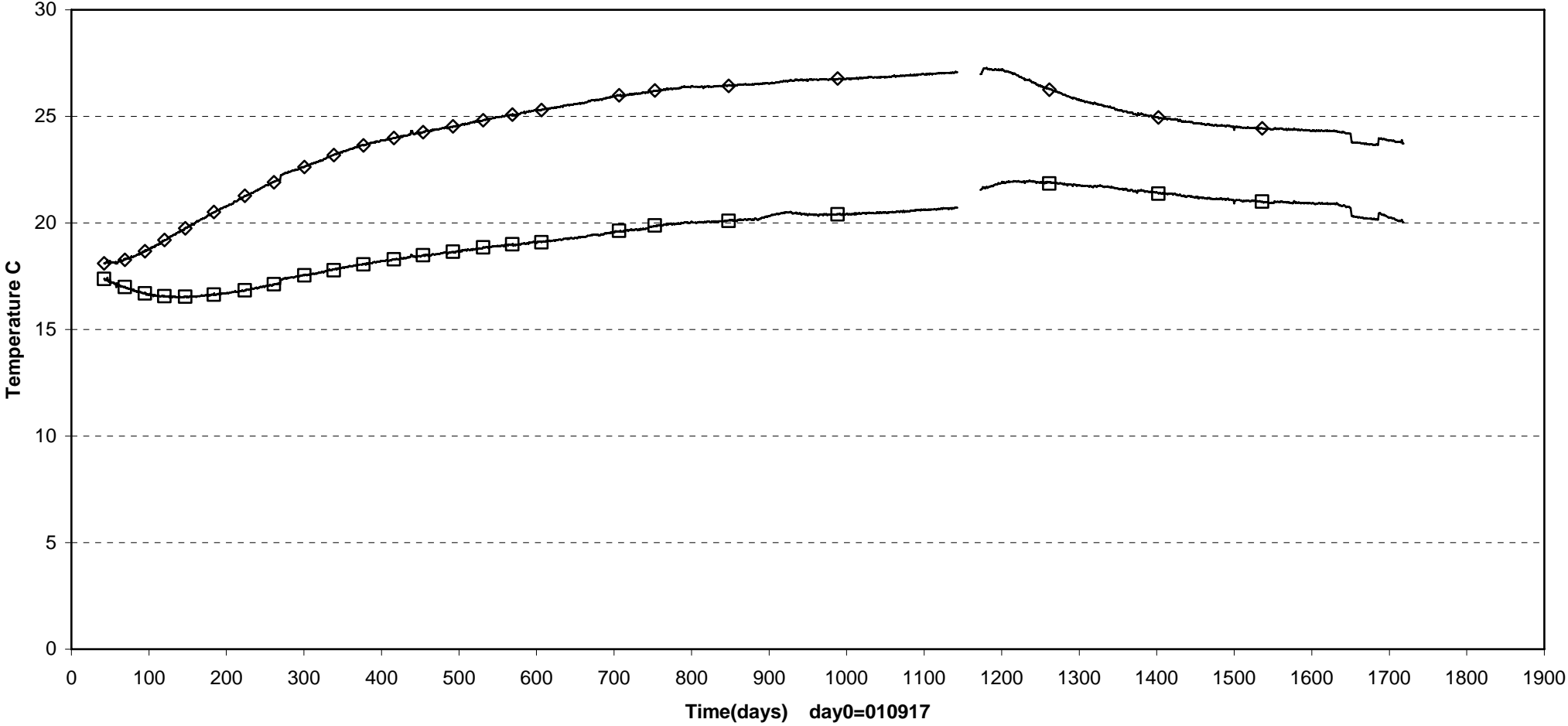
Prototype\ Backfill \ Above dep.hole1 (010917-060601)  
 Temperature - Pentronic



- |                              |                             |                              |                             |
|------------------------------|-----------------------------|------------------------------|-----------------------------|
| □ TBA10001(E1\1.25\0.1\3587) | △ TBA10002(E1\0.1\1.3\3587) | ■ TBA10003(E1\0\0.8\3587)    | ◇ TBA10004(E1\0.5\2.6\3587) |
| ◆ TBA10005(E1\0.5\2.6\3587)  | × TBA10006(E1\0.1\2.3\3587) | ▲ TBA10007(E1\1.25\0.1\3587) |                             |

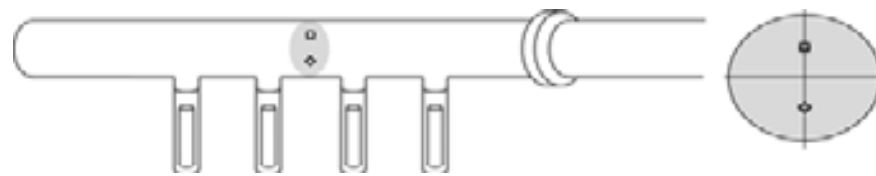
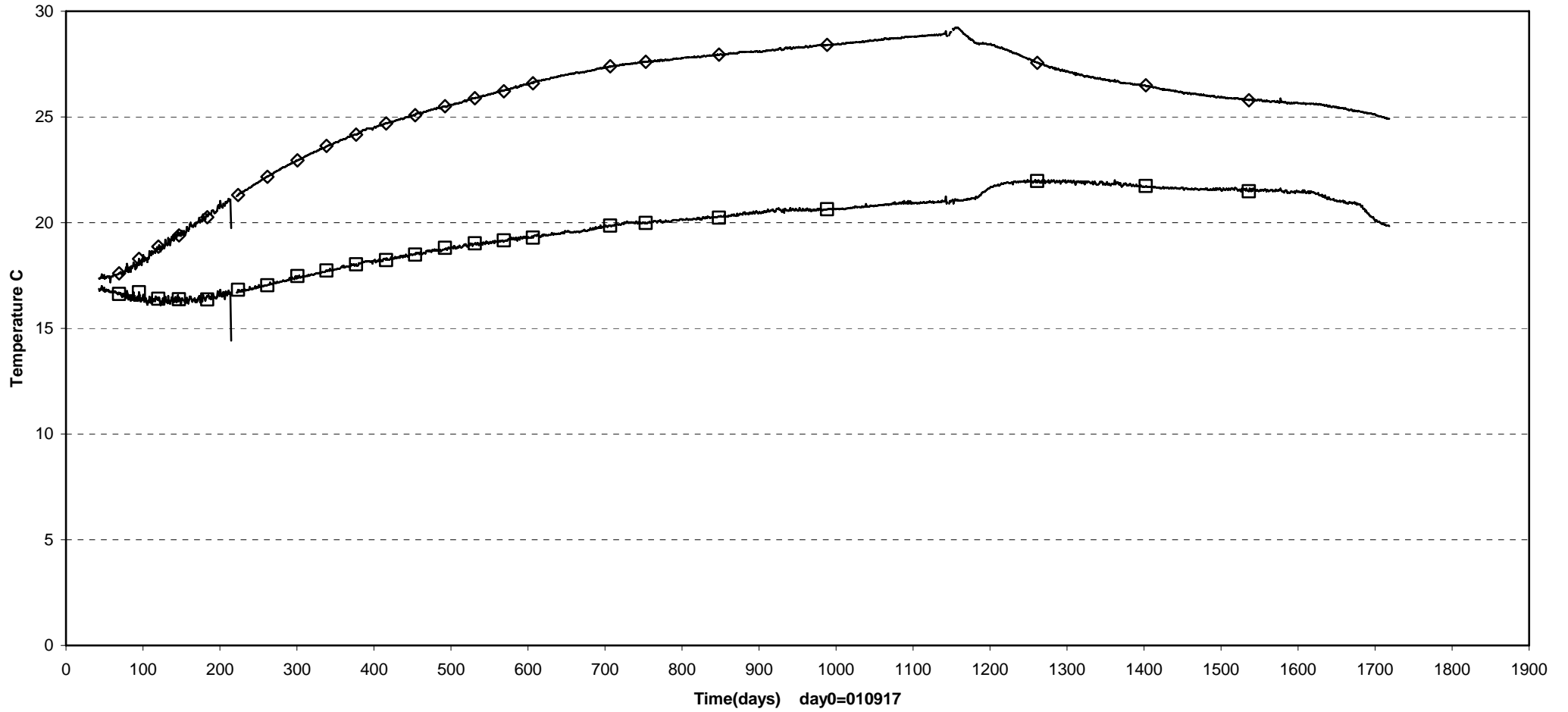


**Prototype\ Backfill \ Between dep.hole 1-2 (010917-060601)**  
**Temperature - Pentronic**



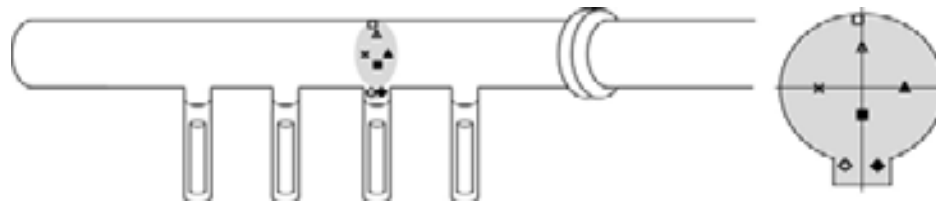
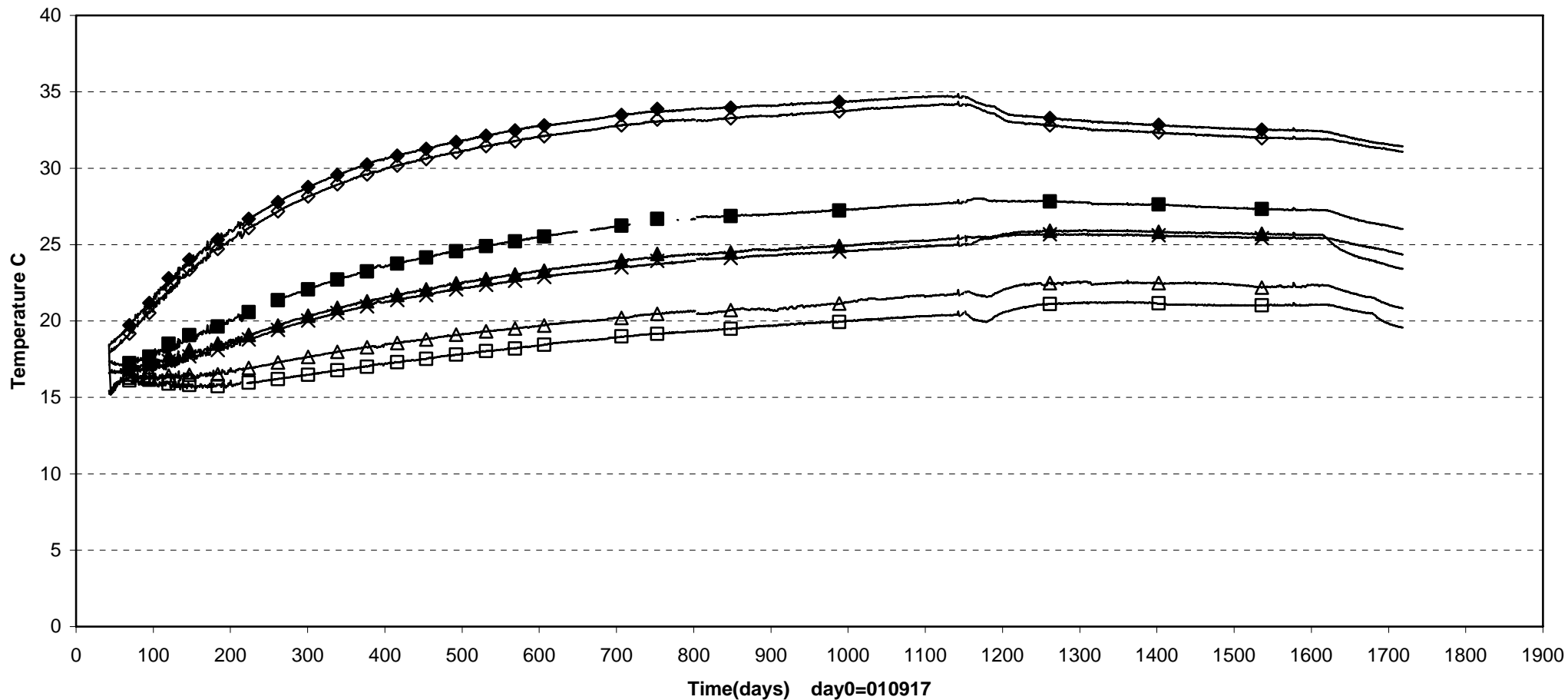
□ TBA10008(F1-2\0\1.25\3584) ◇ TBA10009(F1-2\0\1\1.3\3584)

Prototype \ Backfill \ Between dep.hole 2-3 (010917-060601)  
 Temperature -Pentronic



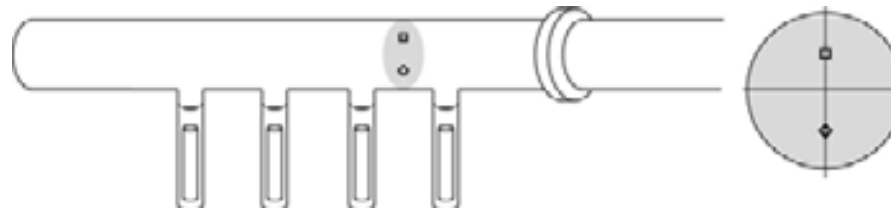
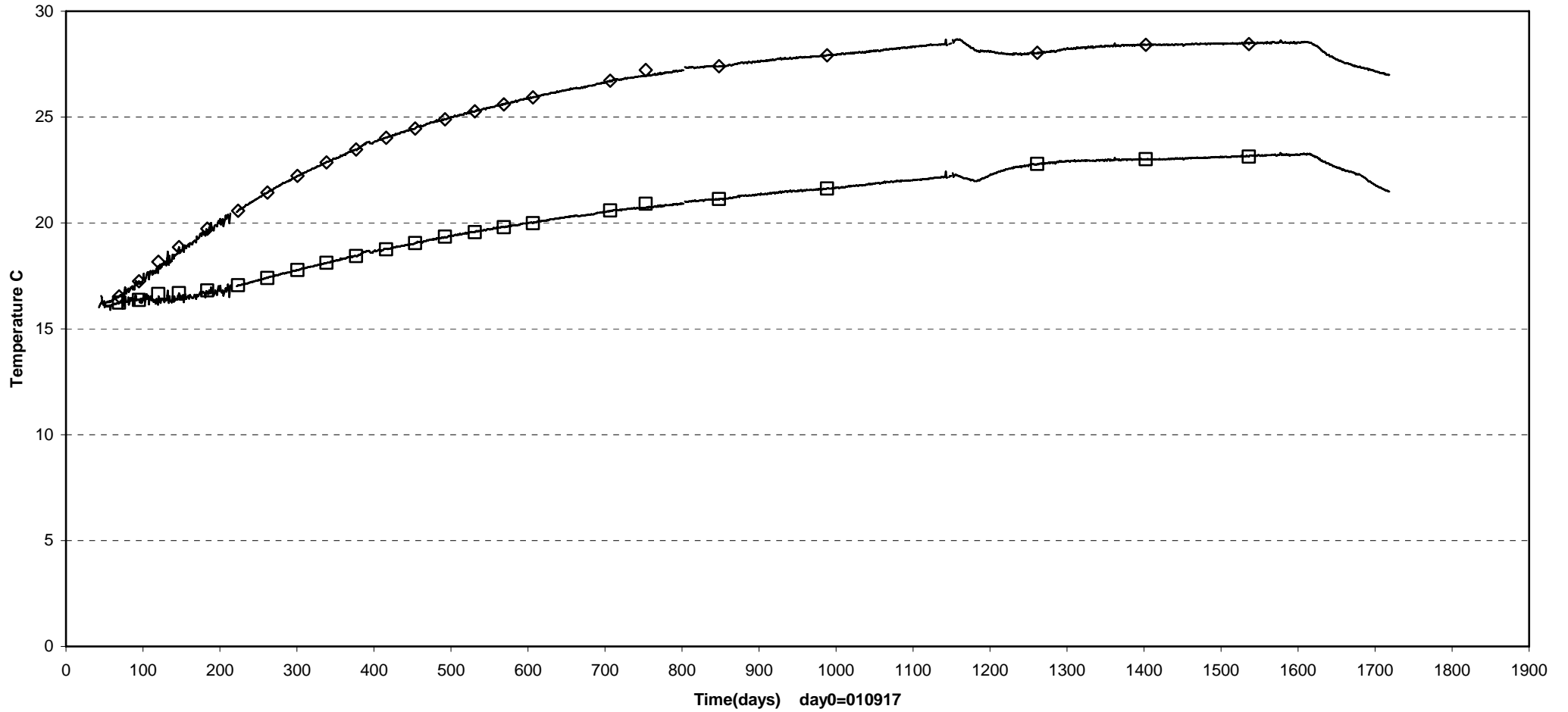
□ TBA10010(F2-3\0\1.15\3578) ◇ TBA10011(F2-3\0\1.24\3578)

Prototype\ Backfill \ Above dep.hole3 (010917-060601)  
 Temperature - Pentronic



- |                               |                             |                             |                               |
|-------------------------------|-----------------------------|-----------------------------|-------------------------------|
| □ TBA10012(E3\0-0.1\2.3\3575) | △ TBA10013(E3\0\1.3\3575)   | ■ TBA10014(E3\0\0-0.9\3575) | ◇ TBA10015(E3\0-0.5\2.6\3575) |
| ◆ TBA10016(E3\0.5\2.6\3575)   | × TBA10017(E3\0-1.3\0\3575) | ▲ TBA10018(E3\1.3\0\3575)   |                               |

Prototype\ Backfill \ Between dep.hole 3-4 (010917-060601)  
 Temperature - Pentronic



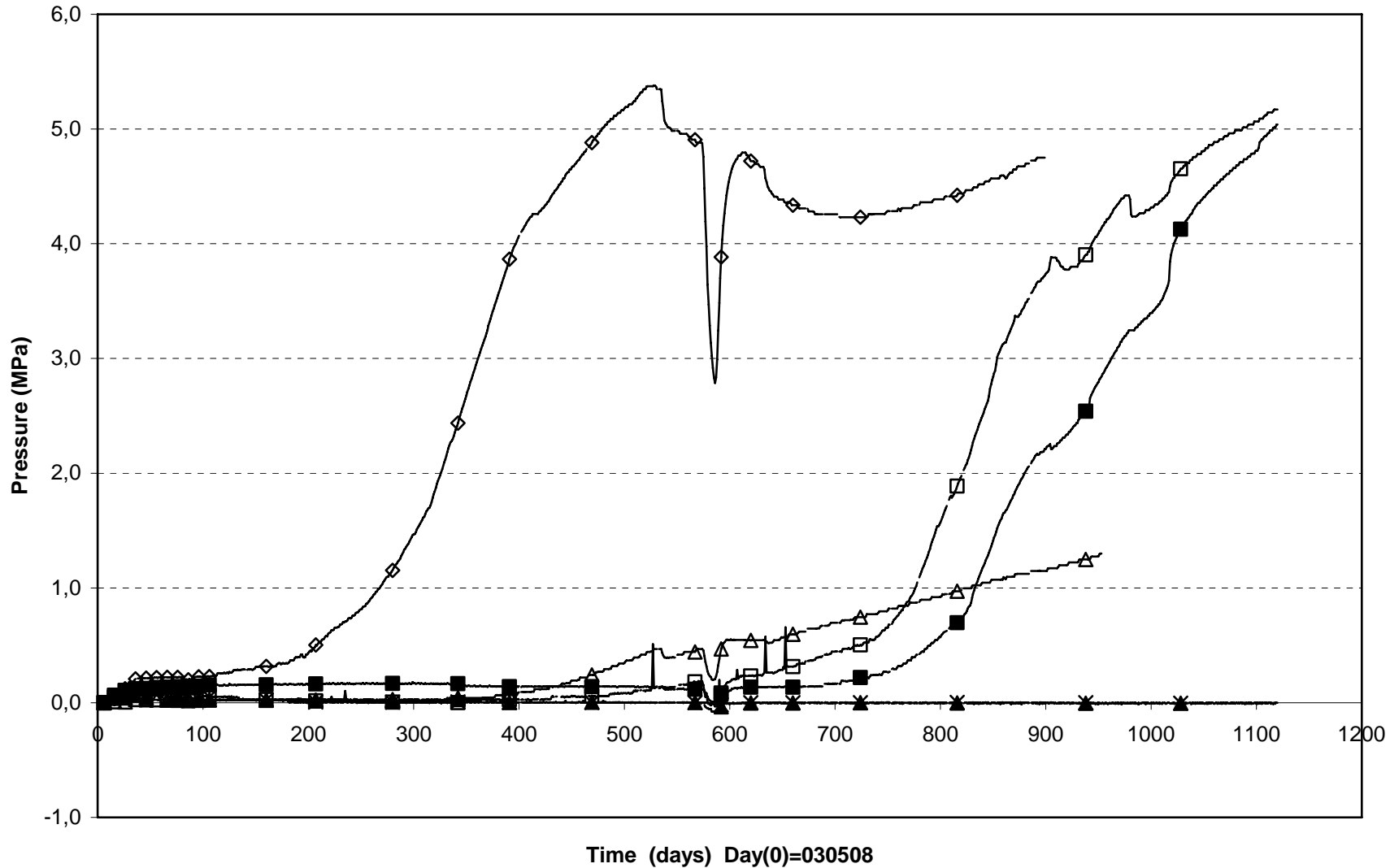
□ TBA10019(F3-4\0\1.2\3572) ◇ TBA10020(F3-4\0\1.3\3572)

## **Appendix 5**

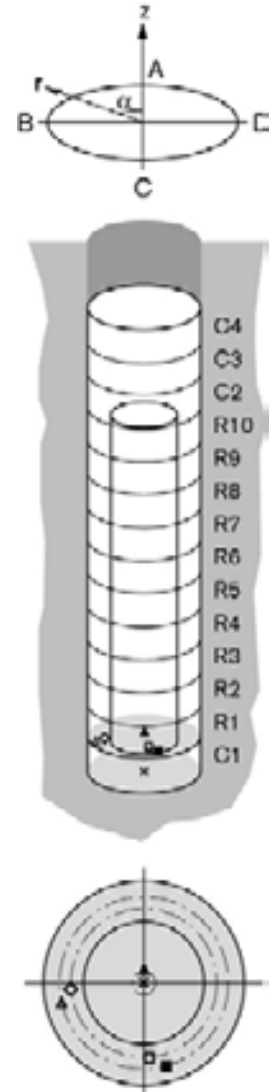
**Dep. hole 5**



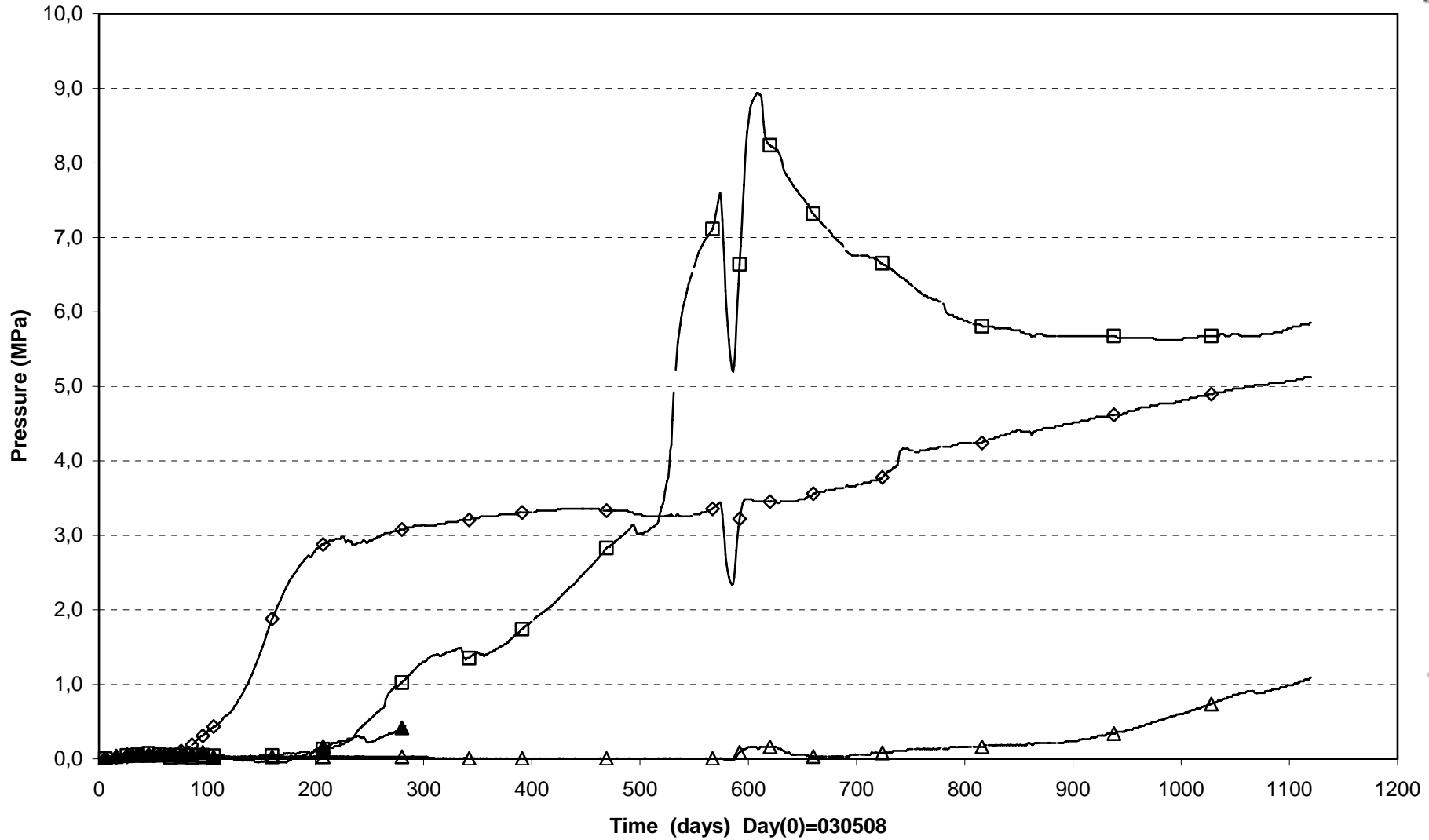
Prototype\Hole 5\Cyl.1 (030508-060601)  
 Total pressure - Geokon



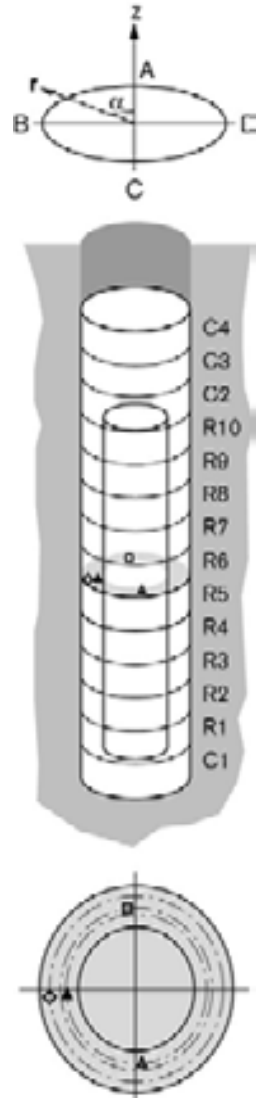
× PB501(0\0°\0)	▲ PB502(0.500\0°\0.100)	◇ PB506(0.500\95°\0.635)
△ PB507(0.500\105°\0.735)	□ PB508(0.500\185°\0.635)	■ PB509(0.500\195°\0.735)



Prototype\Hole 5\Ring5 (030508-060601)  
Total pressure - Geokon

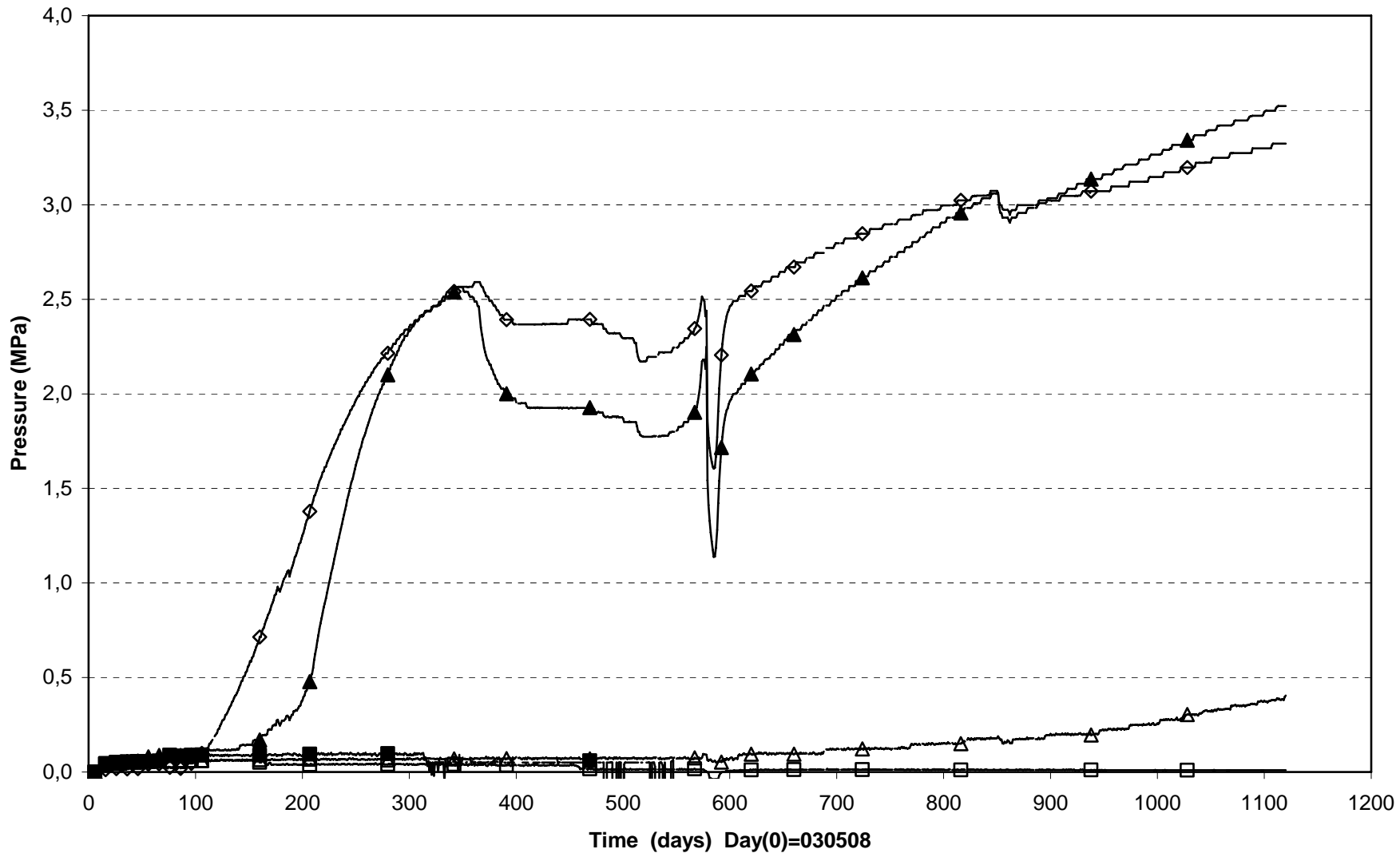


□ PB511(3.036°\5°\0.685)	▲ PB513(3.036°\95°\0.635)
◇ PB514(3.036°\95°\0.785)	△ PB515(3.036°\185°\0.635)

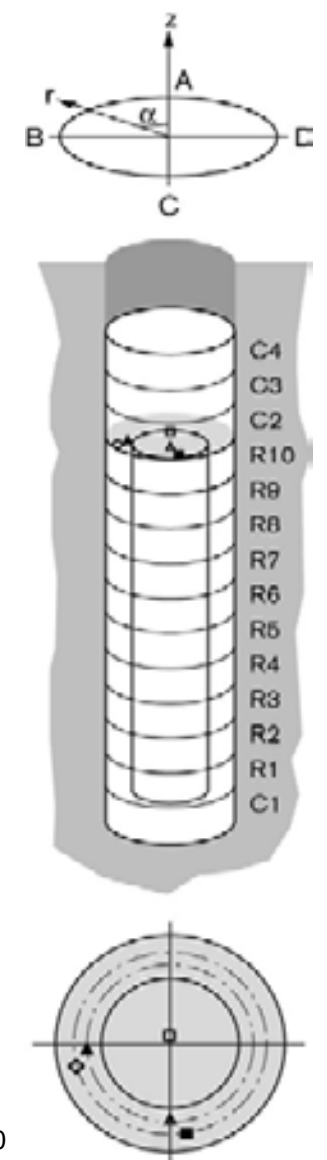




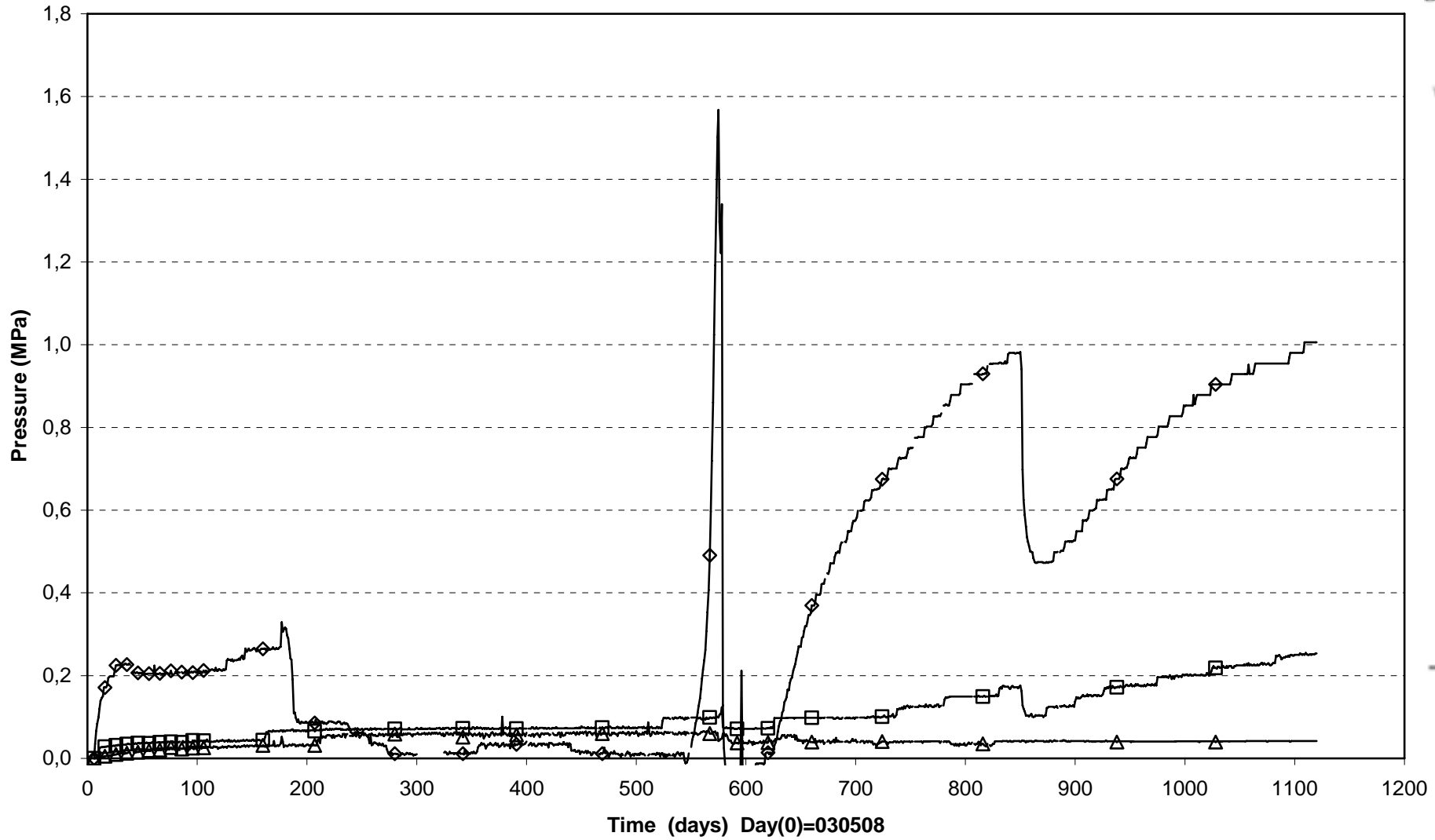
Prototype\Hole 5\Ring10 (030508-060601)  
Total pressure - Geokon



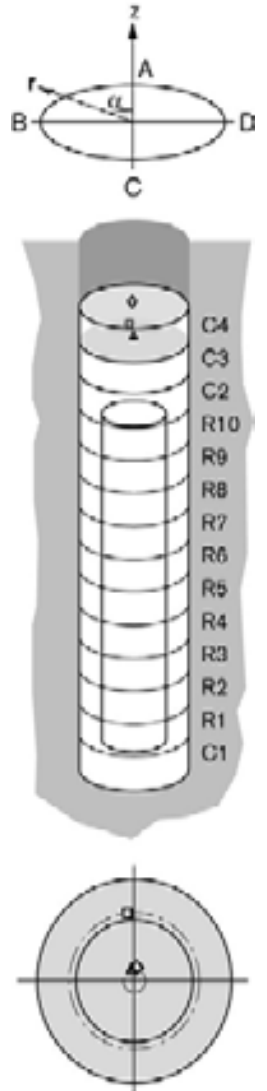
- PB517(5.593\0°\0.050)
- ▲ PB521(5.593\95°\0.635)
- ◇ PB522(5.593\105°\0.735)
- △ PB523(5.593\180°\0.635)
- PB524(5.593\190°\0.735)



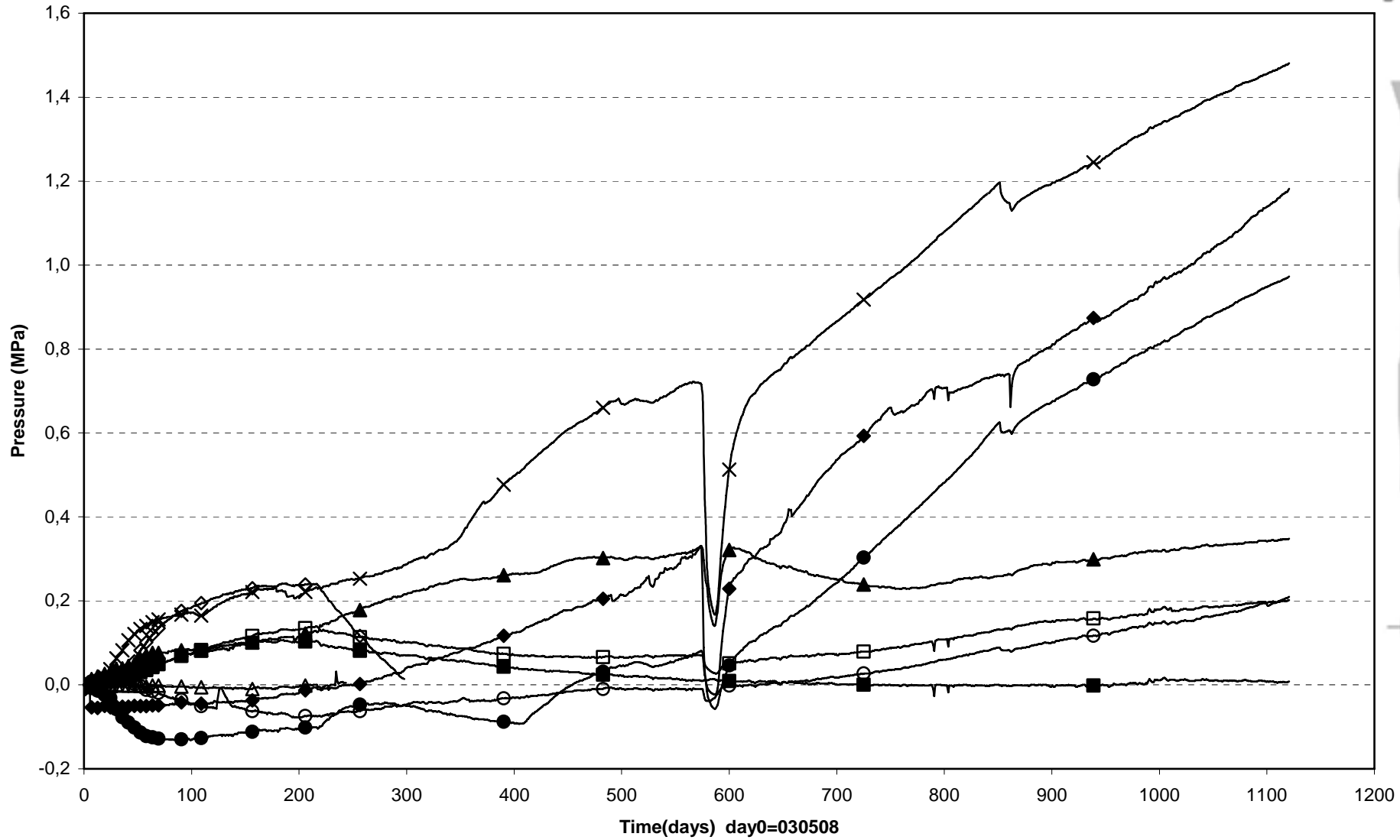
Prototype\Hole 5\Cyl.3 and Cyl.4 (030508-060601)  
 Total pressure - Geokon



△ PB525(6.603\0°\0.100)
□ PB526(6.603\5°\0.585)
◇ PB527(7.110\0°\0.100)

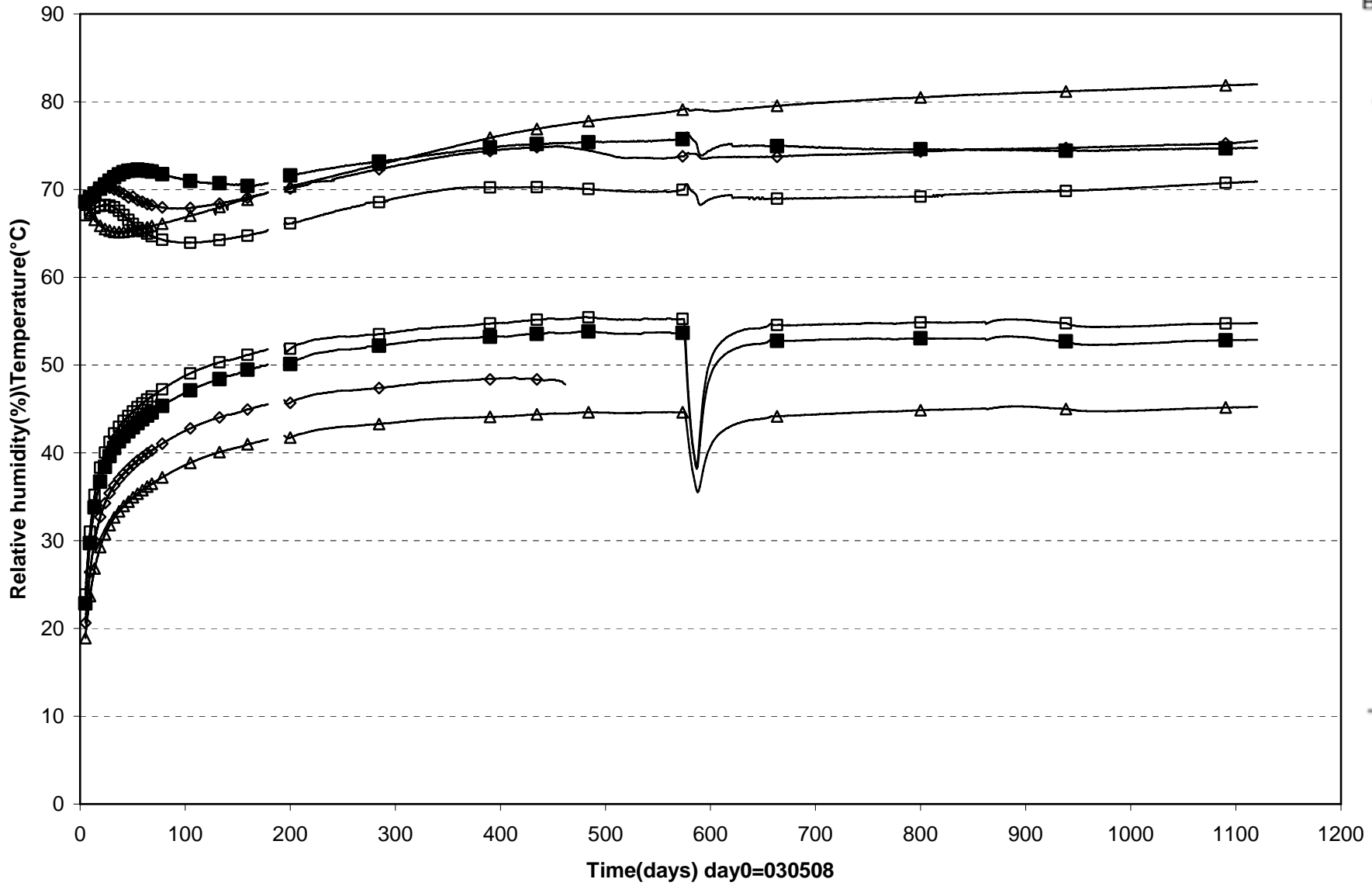


Prototype\ Hole 5 (030508-060601)  
 Total pressure - Kulite

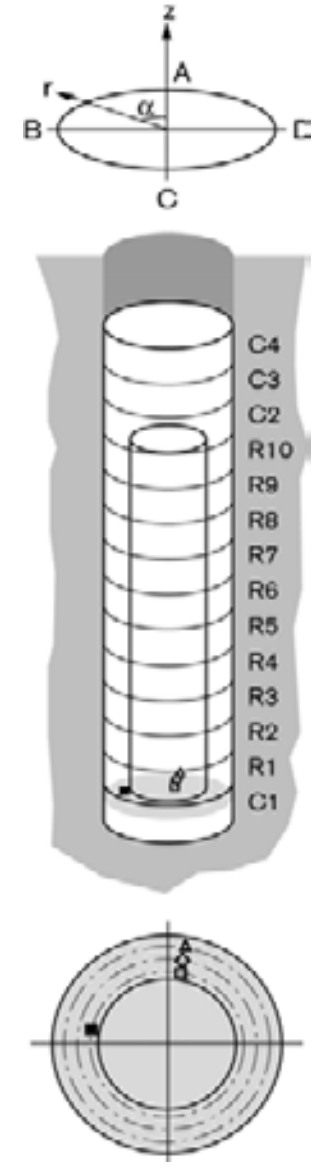


- |                            |                           |                           |                           |                          |
|----------------------------|---------------------------|---------------------------|---------------------------|--------------------------|
| □ PB503(0.340 \5° 0.585)   | ■ PB504(0.340 \5° 0.685)  | ◇ PB505(0.340 \5° 0.785)  | ◆ PB510(2.876 \10° 0.535) | △ PB512(2.876 \5° 0.825) |
| ▲ PB516(2.876 \190° 0.825) | ○ PB518(5.433 \10° 0.585) | ● PB519(5.433 \10° 0.685) | ×                         | ×                        |

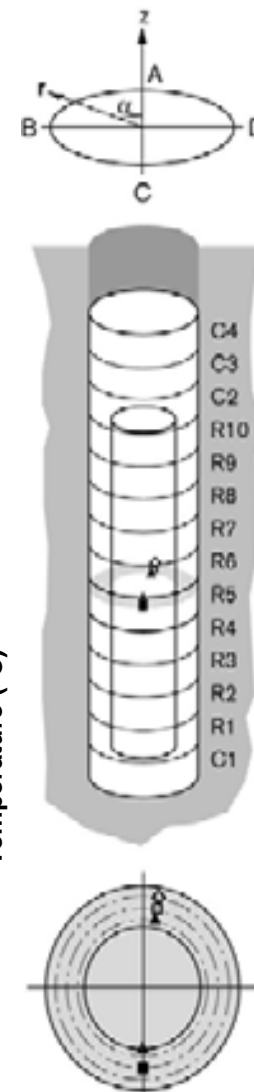
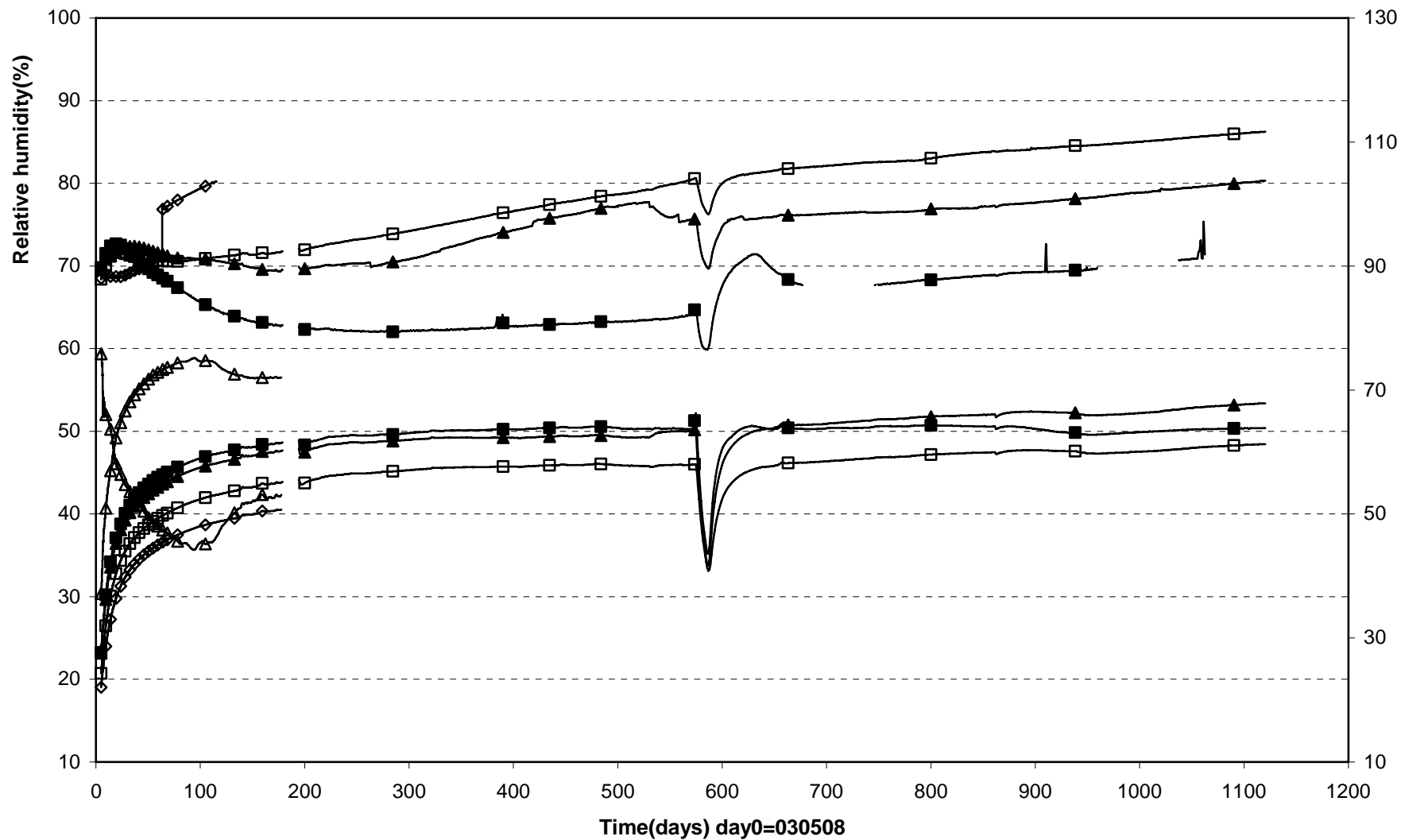
Prototype\Hole 5\Cyl.1 (030508-060601)  
Relative humidity - Vaisala



□ WB504(0.340\350°\0.585)    ◇ WB505(0.340\350°\0.685)    △ WB506(0.340\350°\0.785)    ■ WB507(0.340\80°\0.585)

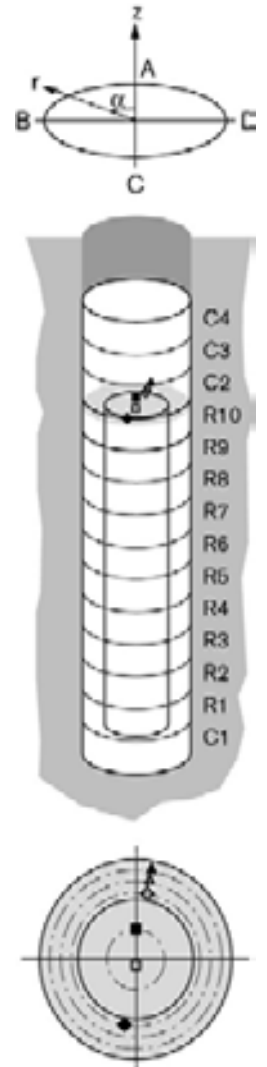
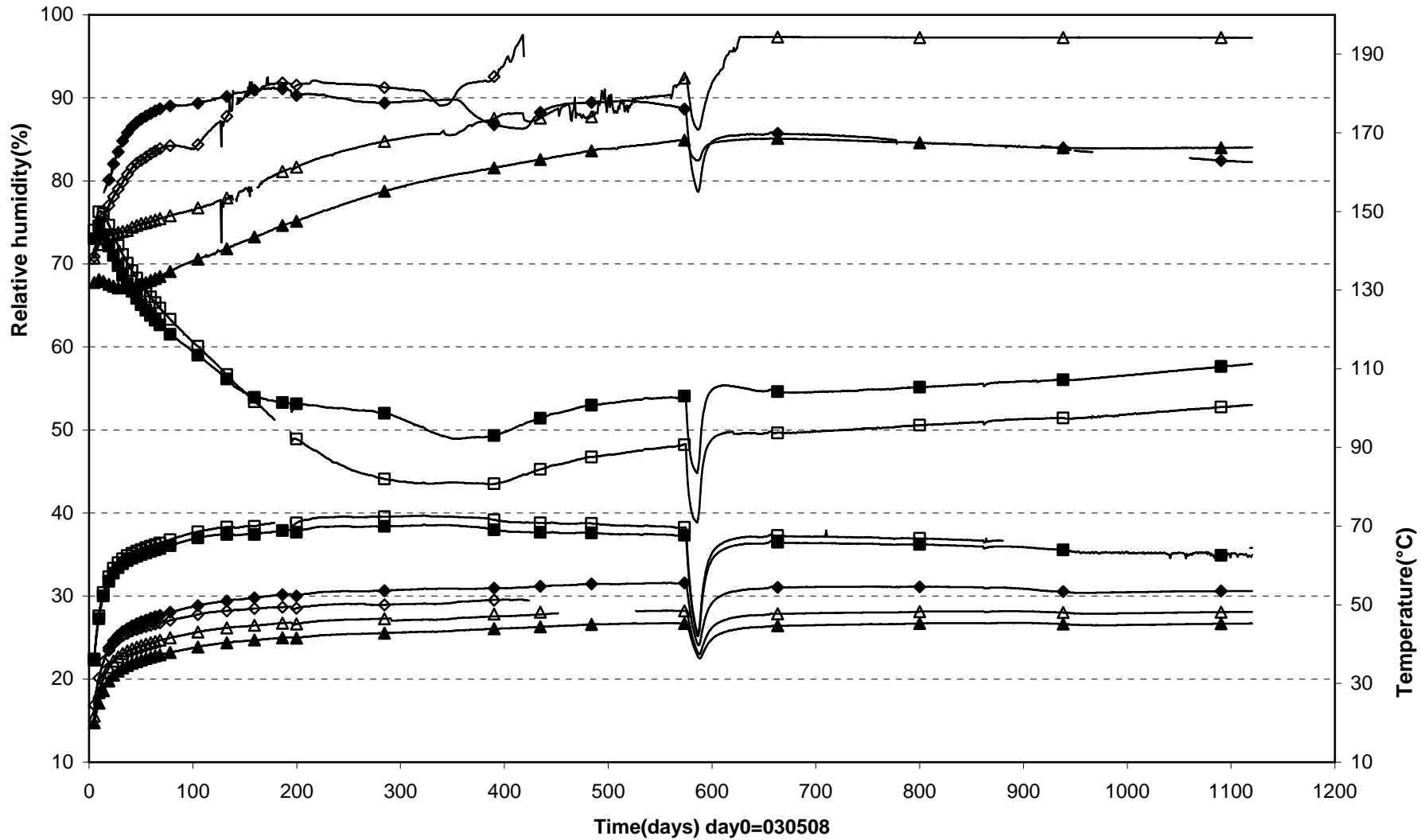


Prototype\Hole 5\Ring 5 (030508-060601)  
Relative humidity - Vaisala



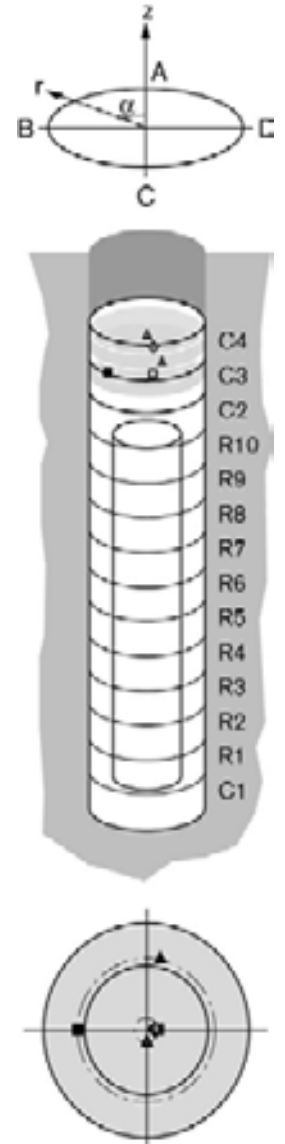
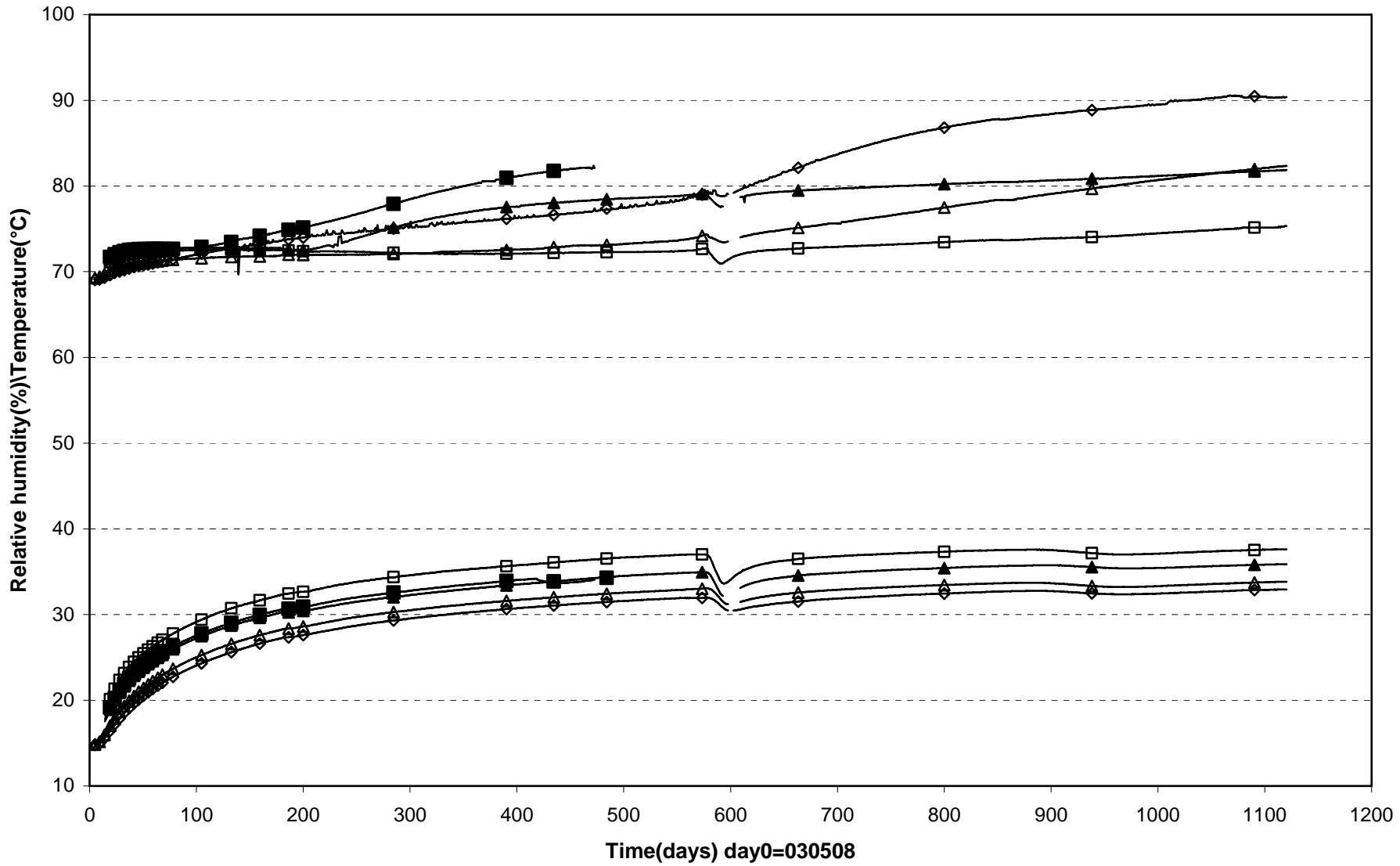
▲ WB513(2.876\350°\0.585)    □ WB514(2.876\350°\0.685)    ◇ WB515(2.876\350°\0.785)    △ WB519(2.876\180°\0.535\In the slot)    ■ WB520(2.876\180°\0.685)

Prototype\Hole 5\Ring 10 (030508-060601)  
Relative humidity - Vaisala



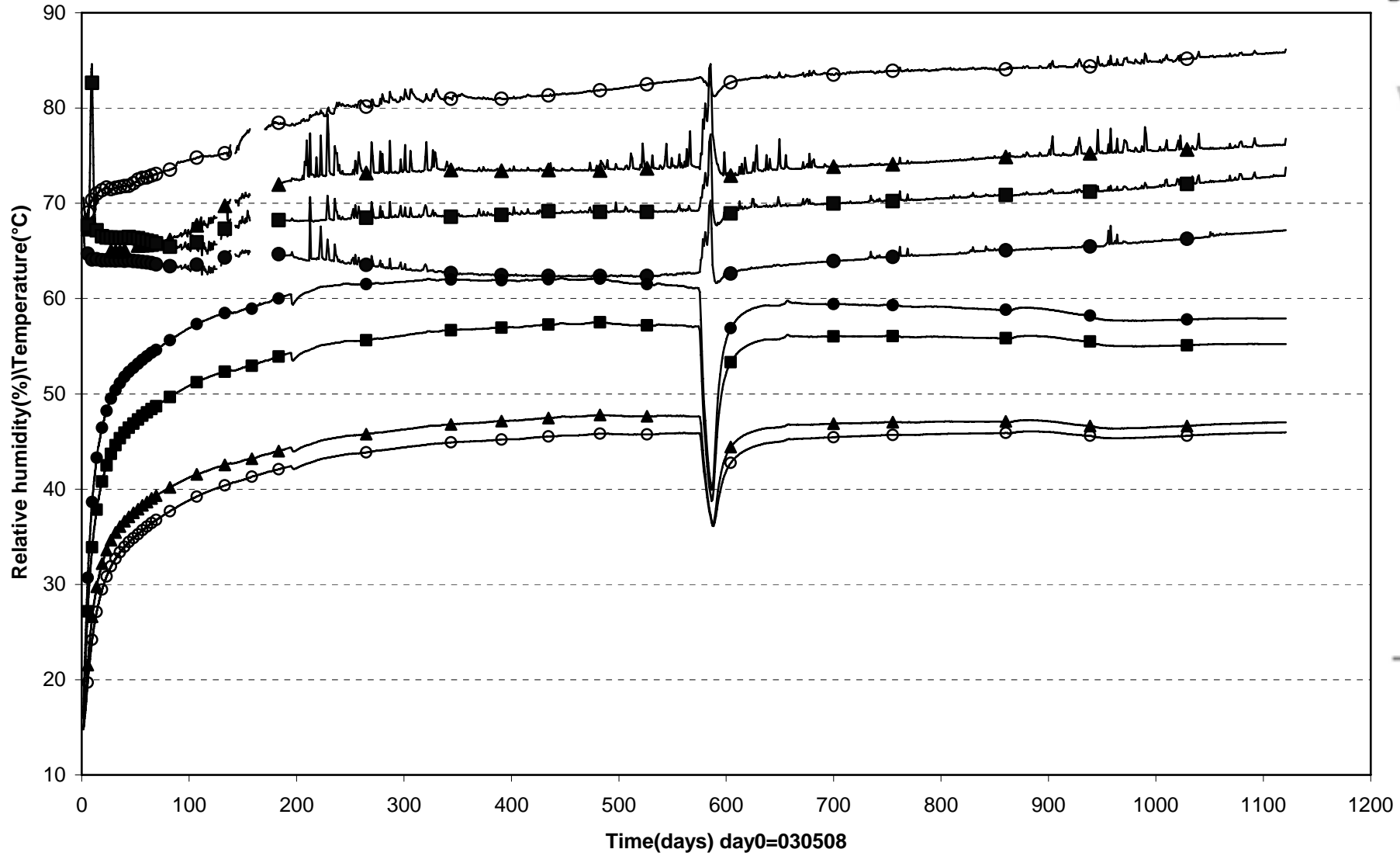
□ WB522(5.433\180°\0.050) ■ WB523(5.433\ 0° \0.262) ◇ WB524(5.433\350°\0.585) △ WB525(5.433\350°\0.685) ▲ WB526(5.433\350°\0.785) ◆ WB530(5.433\170°\0.585)

Prototype\Hole 5\Cyl.3 and Cyl.4 (030508-060601)  
Relative humidity - Vaisala

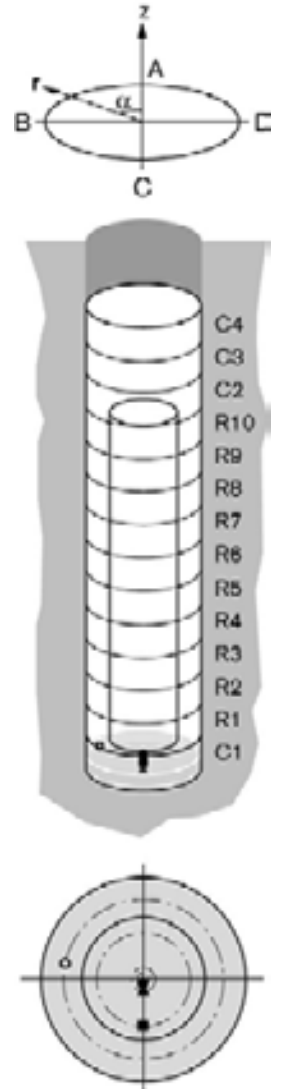


□ WB532(6.353\270°\0.100) ▲ WB533(6.353\350°\0.585) ■ WB534(6.353\90°\0.585) △ WB536(6.790\180°\0.100) ◇ WB537(6.950\270°\0.100)

Prototyp\Hole 5\Cyl.1 (030508-060601)  
Relative humidity - Rotronic

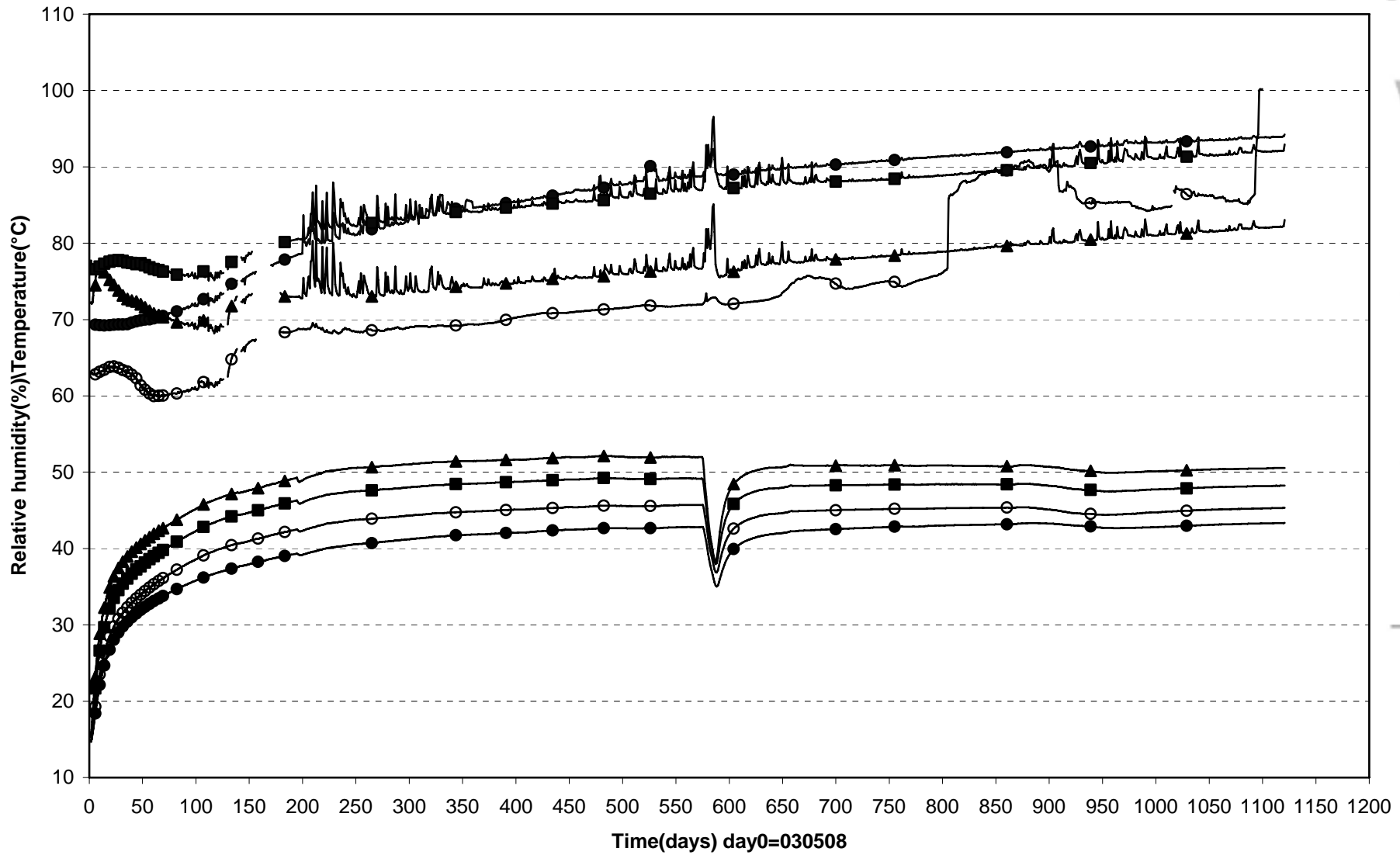


● WB501 (0.250\180°\0.050) ▲ WB502 (0.05\180°\0.100) ■ WB503 (0.250\180°\0.400) ○ WB508(0.250\80°\0.685)

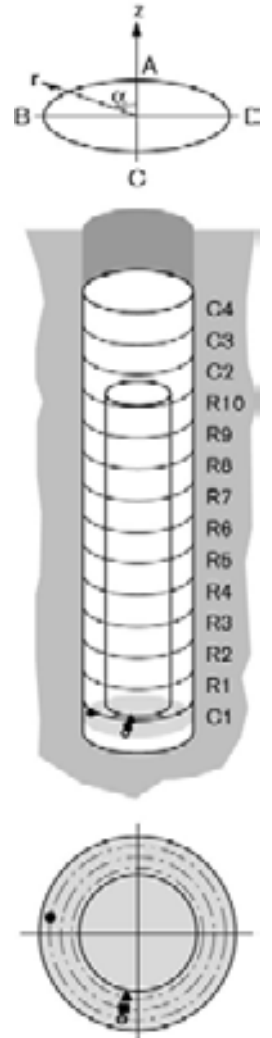




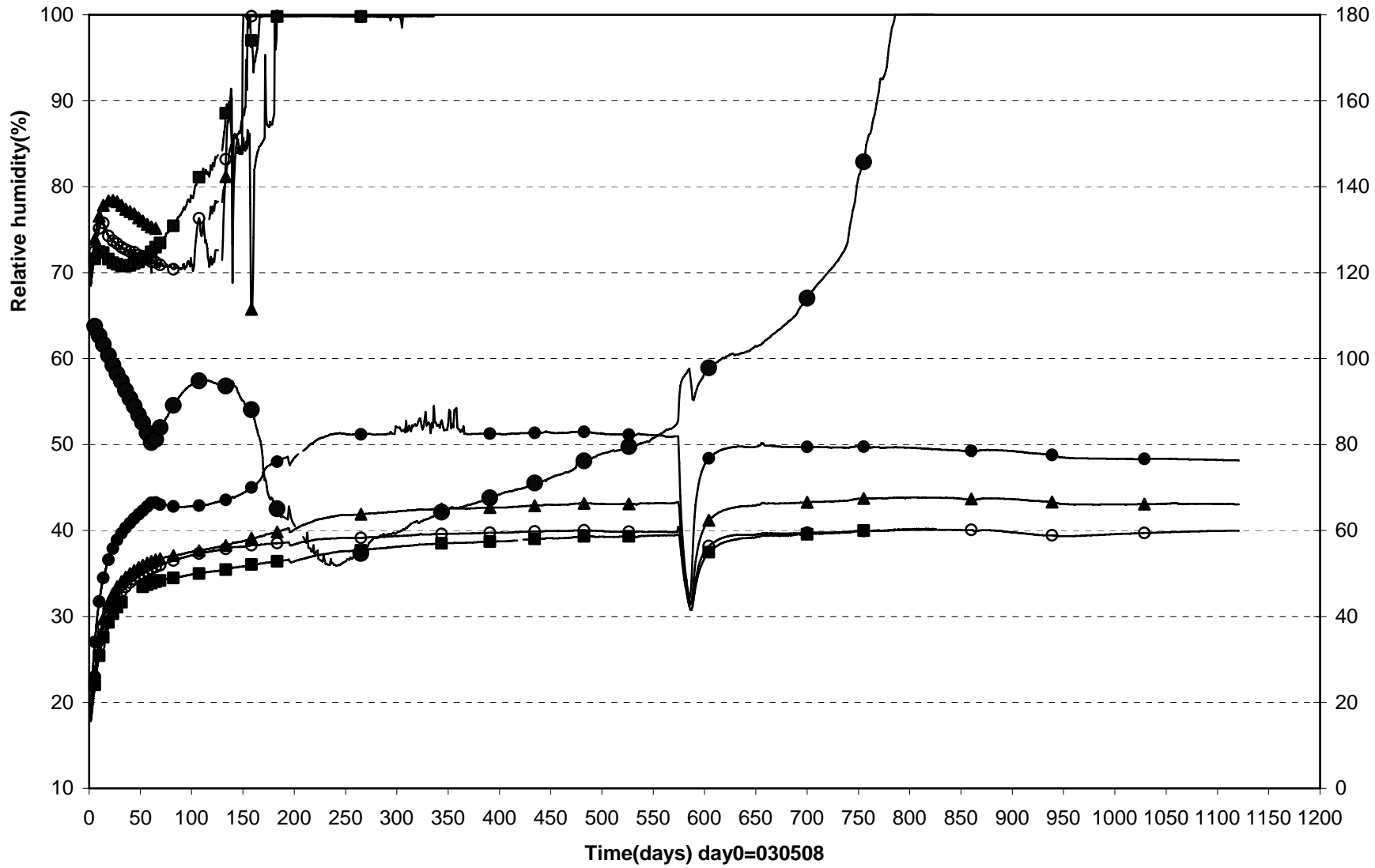
Prototyp\Hole 5\Cyl.1 (030508-060601)  
 Relative humidity - Rotronic



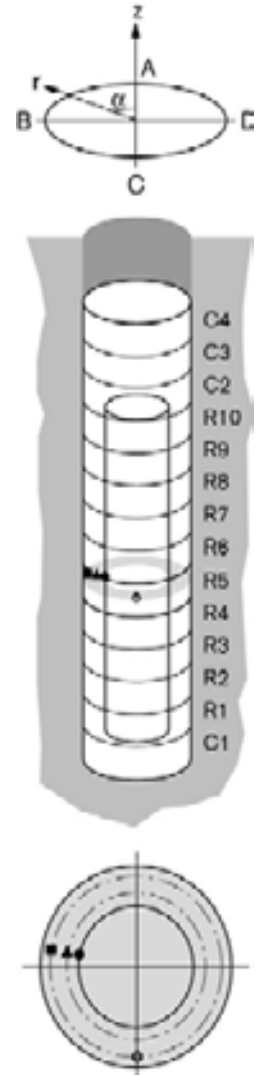
● WB509(0.250\80°\0.785) ▲ WB510(0.250\170°\0.585) ■ WB511(0.250\170°\0.685) ○ WB512(0.250\170°\0.785)



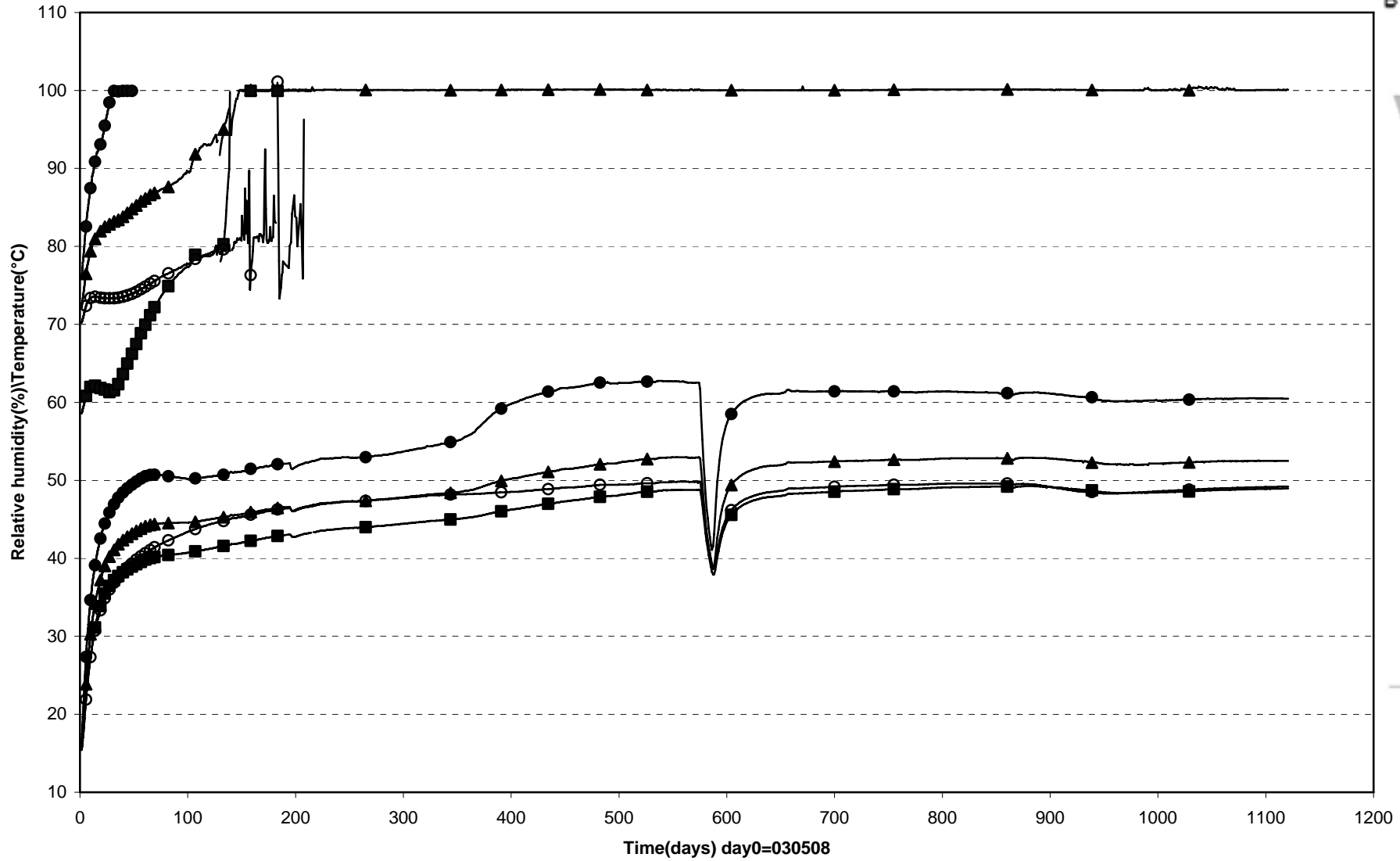
Prototyp\Hole 5\Ring5 (030508-060601)  
Relative humidity - Rotronic



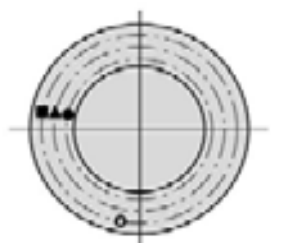
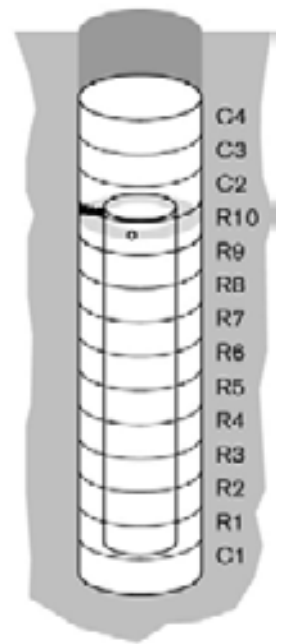
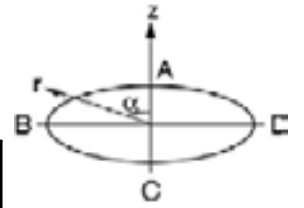
● WB516(2.786\80°\0.535) ▲ WB517(2.786\80°\0.685) ■ WB518(2.786\80°\0.785) ○ WB521(2.786\180°\0.785)



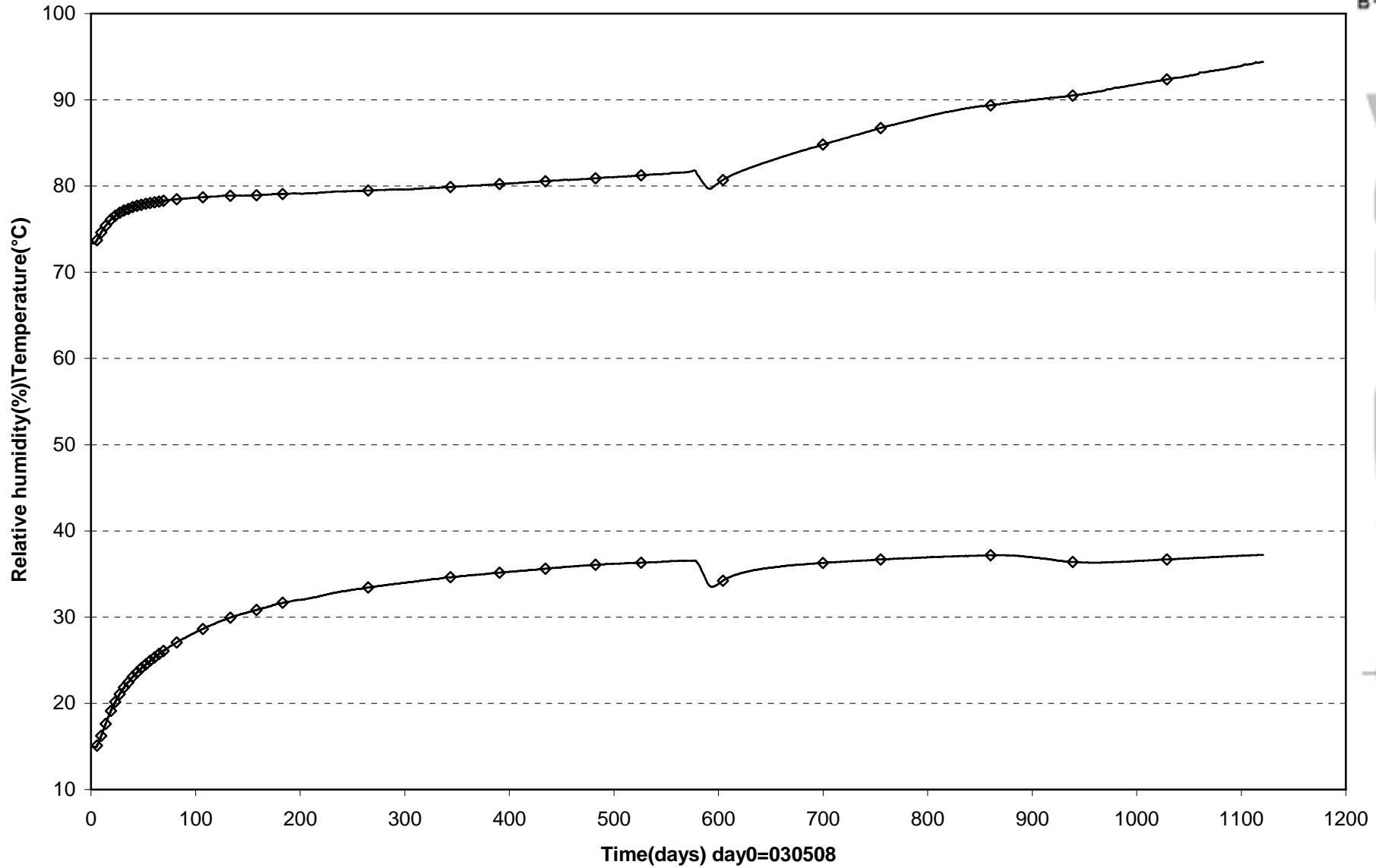
Prototyp\Hole 5\Ring10 (030508-060601)  
 Relative humidity - Rotronic



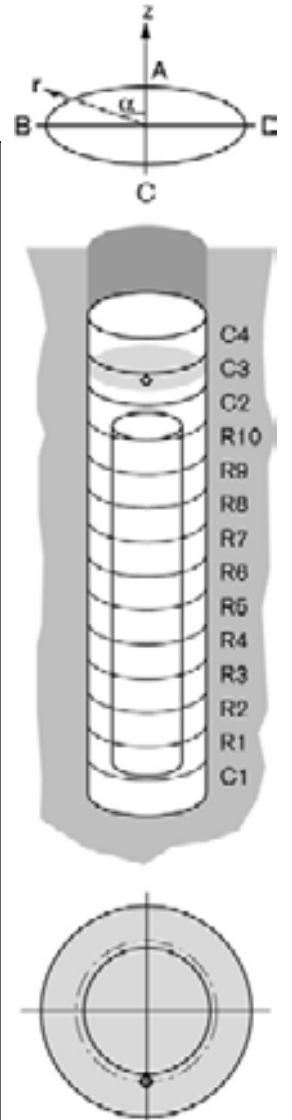
● WB527(5.343\80°\0.585) ▲ WB528(5.343\80°\0.685) ■ WB529(5.343\80°\0.785) ○ WB531(5.343\170°\0.785)



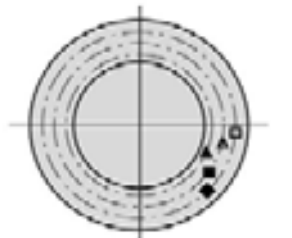
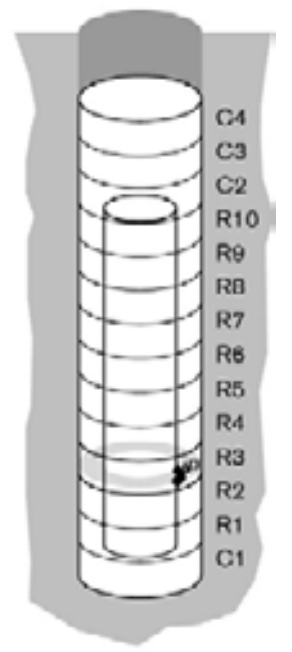
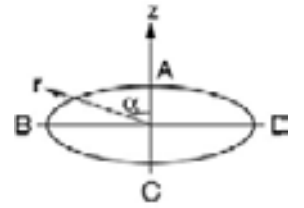
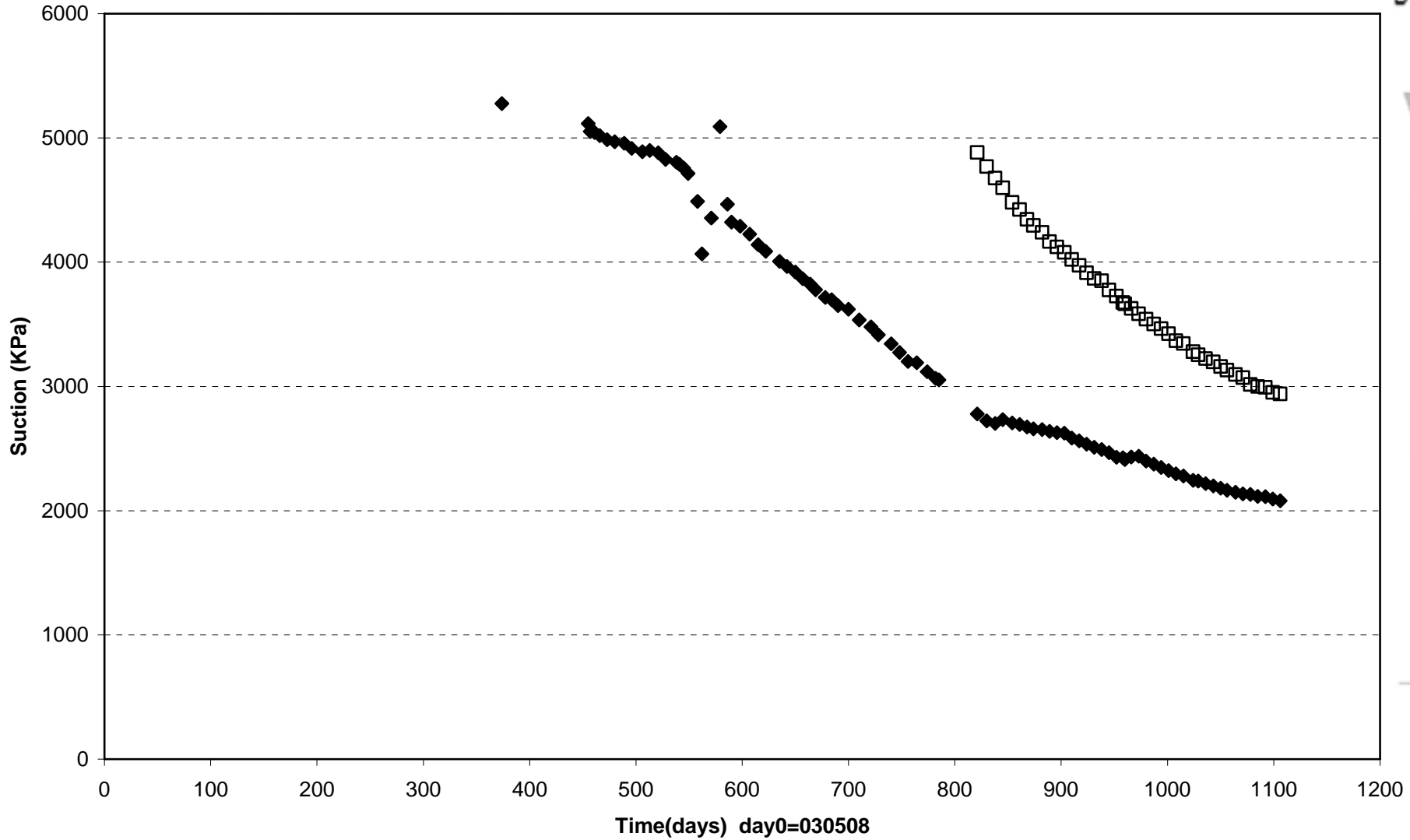
Prototyp\Hole 5\Cyl.3 (030508-060601)  
 Relative humidity - Rotronic



◇ WB535(6.353\180°\0.585)

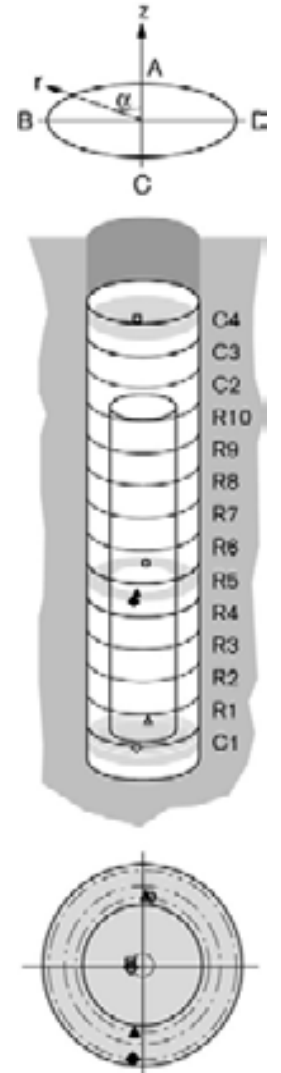
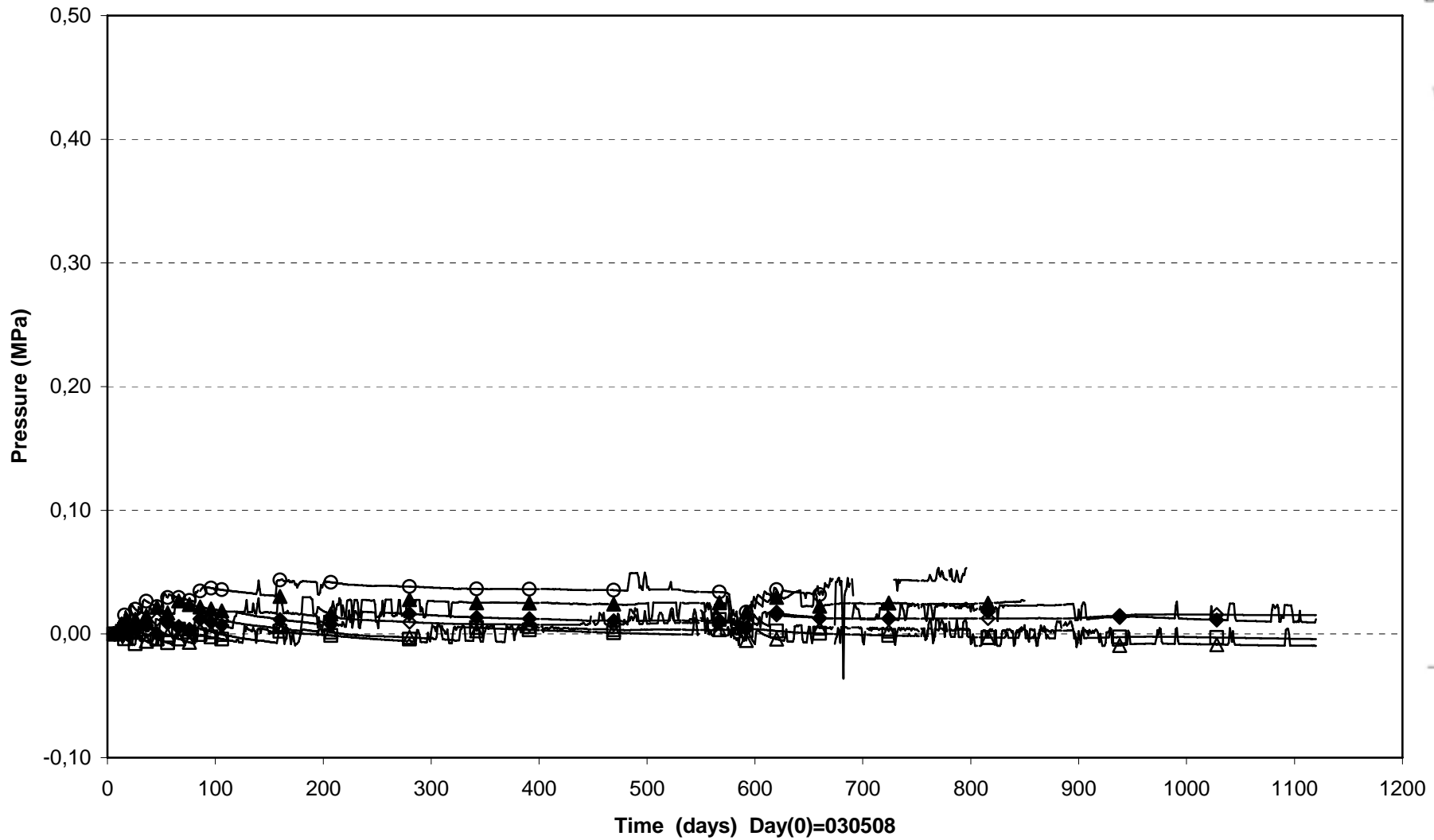


Prototype\ Hole 5 \ Ring 3 (030508-060601)  
Suction - Wescor



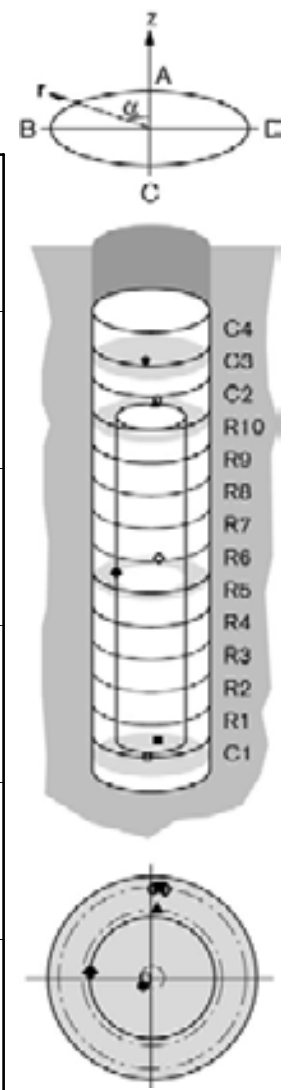
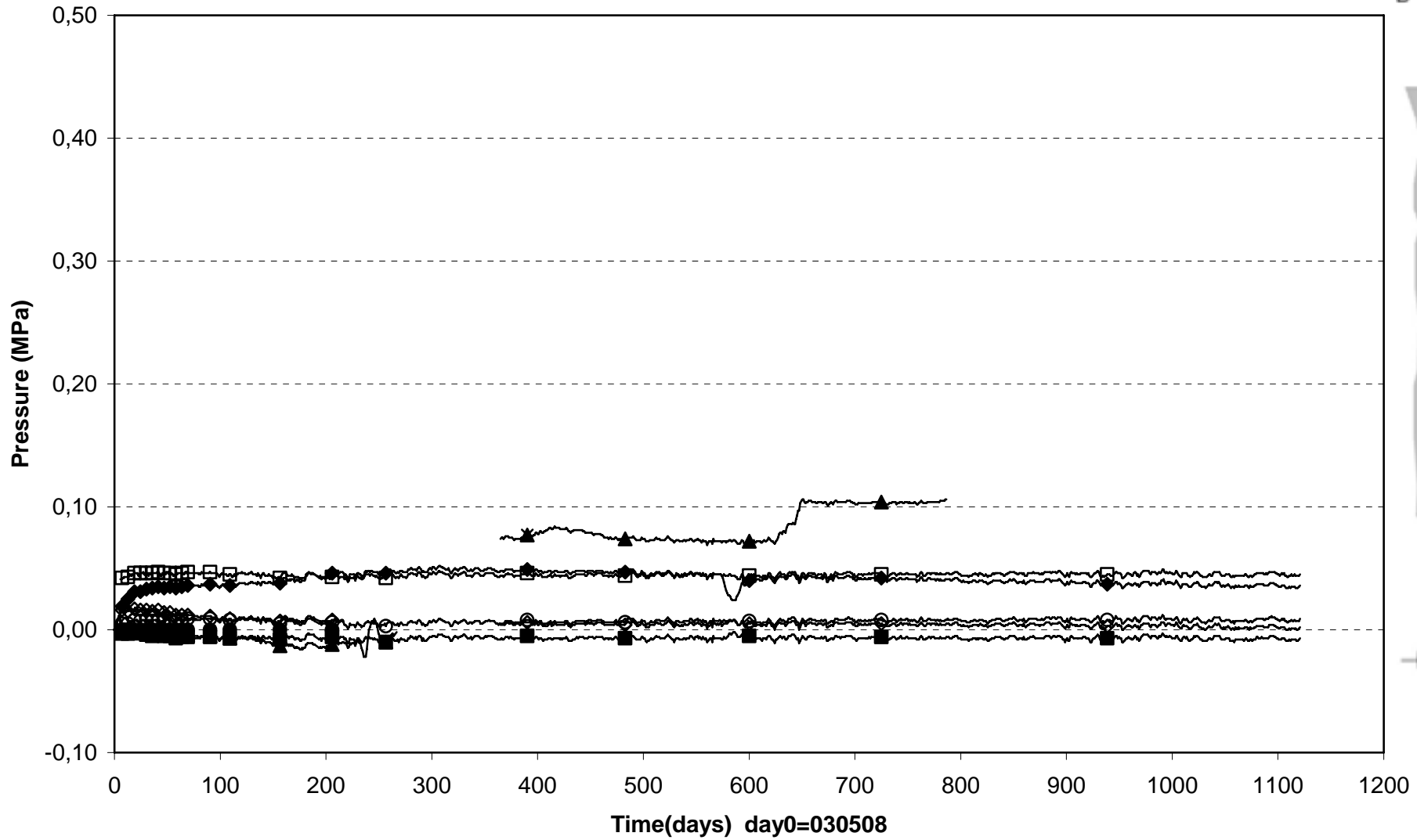
◆ WB538(1.624\225°\0.775) ■ WB539(1.624\235°\0.680) ▲ WB540(1.624\245°\0.585) △ WB541(1.624\255°\0.680) □ WB542(1.624\265°\0.775)

Prototype\Hole5 (030508-060601)  
Pore pressure - Geokon



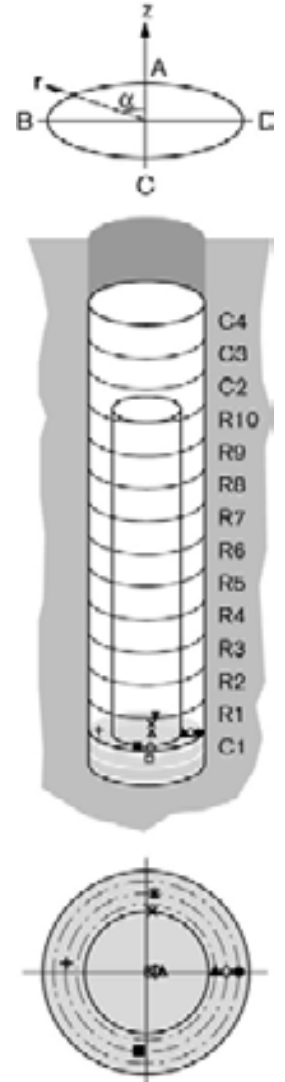
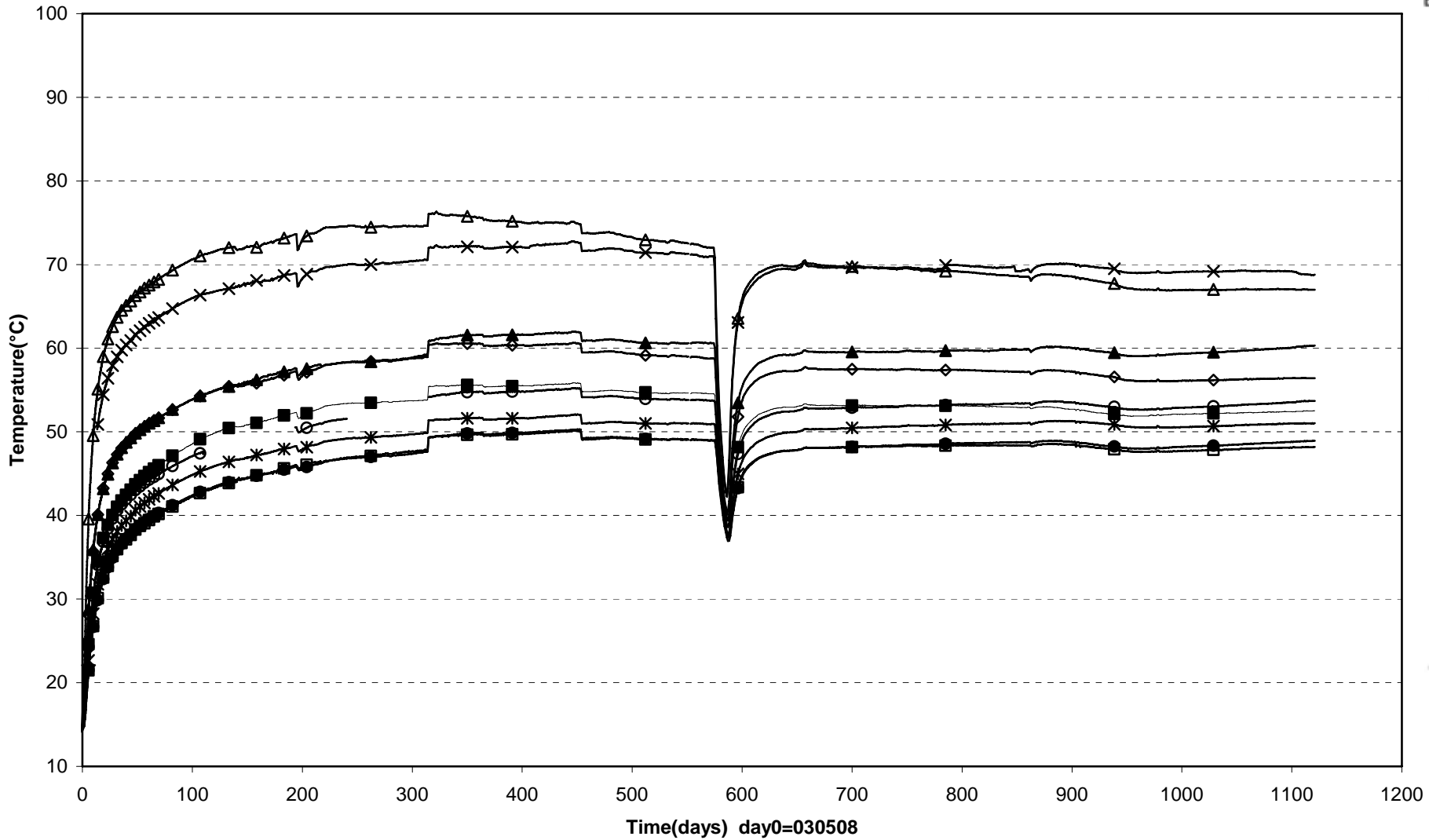
◇ UB502(0.050\90°\0.100)	△ UB503(0.250\355°\0.585)	○ UB505(2.786\355°\0.585)
▲ UB509(2.786\175°\0.535)	◆ UB510(2.786\175°\0.825)	□ UB514(6.860\90°\0.100)

Prototype\ Hole 5 (030508-060601)  
Pore pressure - Kulite



□ UB501(0.250 \90°\ 0.050)    ■ UB504(0.340 \355°\ 0.785)    ◇ UB506(2.876 \355°\ 0.785)    ◆ UB507(2.876 \85°\ 0.535)  
 ▲ UB511(5.433 \355°\ 0.585)    ○ UB512(5.433 \355°\ 0.785)    ● UB513(6.250 \135°\ 0.100)

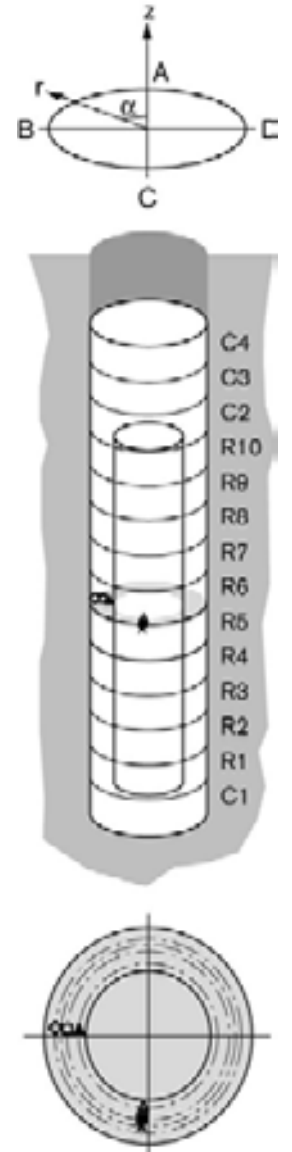
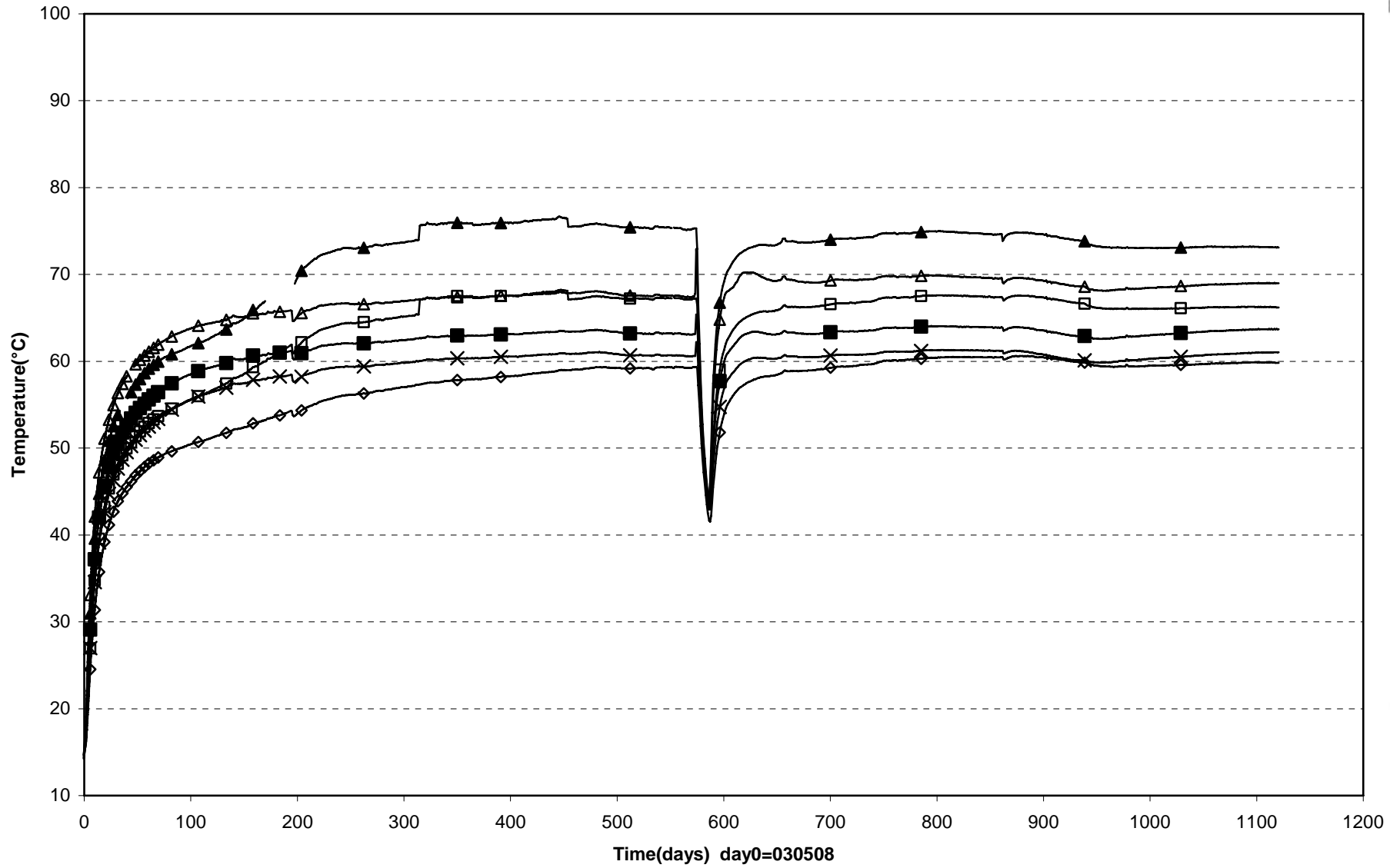
Prototype\Hole 5\Cyl.1 (030508-060601)  
 Temperature - Pentronic



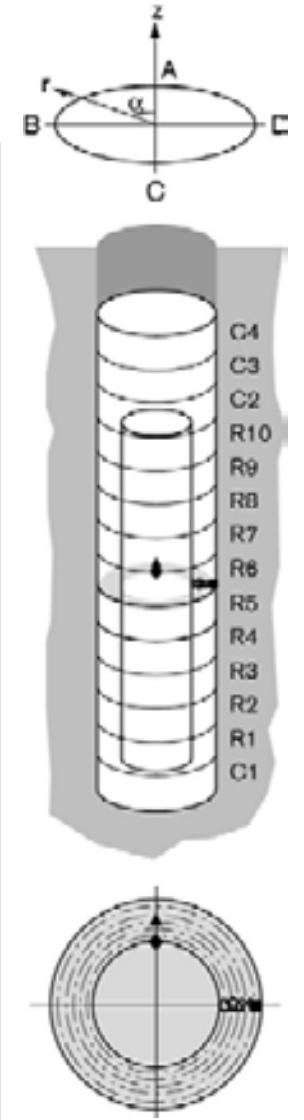
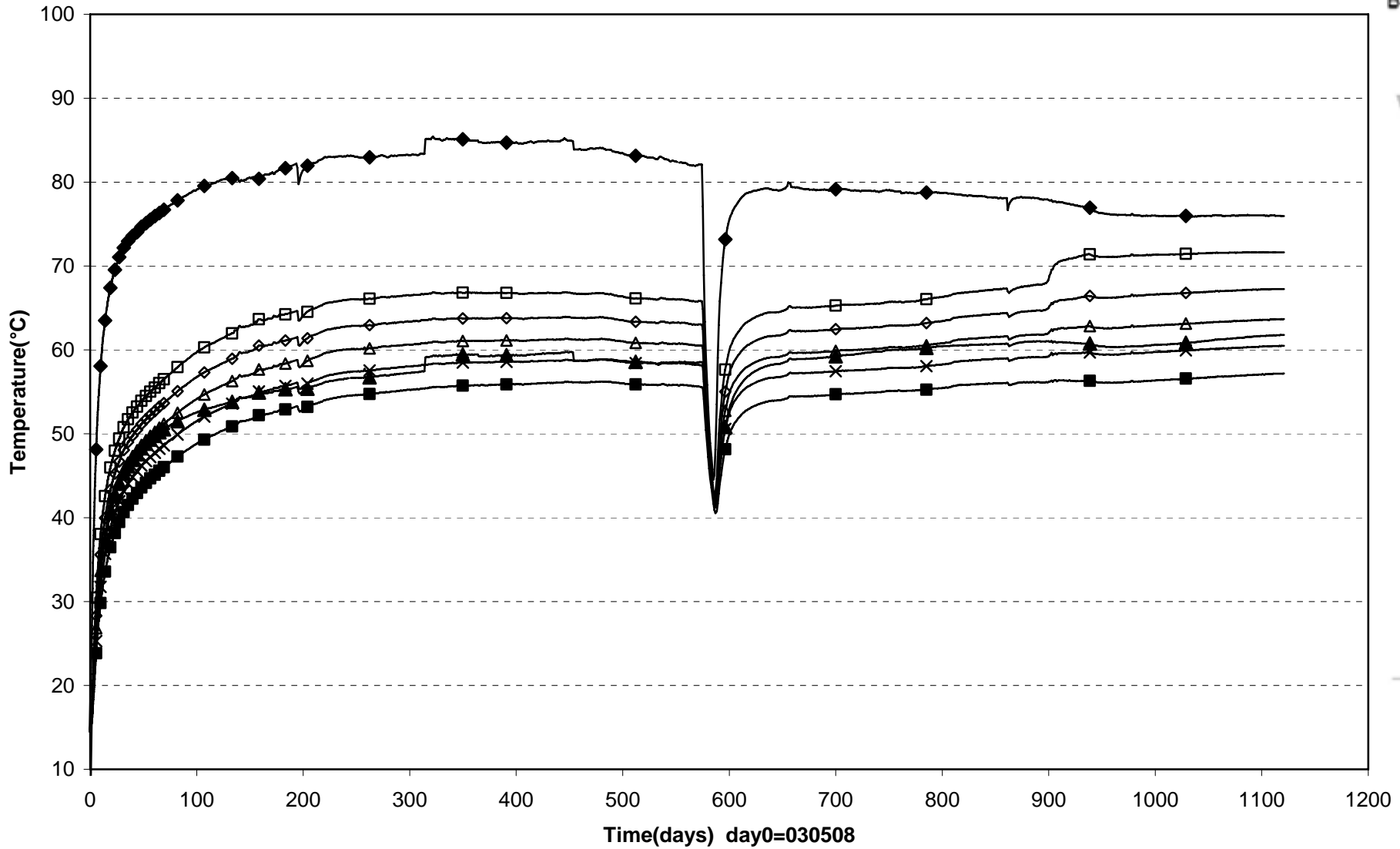
- |                           |                           |                           |                           |                           |
|---------------------------|---------------------------|---------------------------|---------------------------|---------------------------|
| □ TB501(0.080\270°\0.050) | ◇ TB502(0.250\270°\0.060) | △ TB503(0.450\270°\0.070) | × TB504(0.450\355°\0.525) | ✱ TB505(0.450\355°\0.685) |
| + TB506(0.450\85°\0.685)  | ■ TB507(0.450\175°\0.685) | ▲ TB508(0.450\270°\0.585) | ○ TB509(0.450\270°\0.685) | ● TB510(0.450\270°\0.785) |



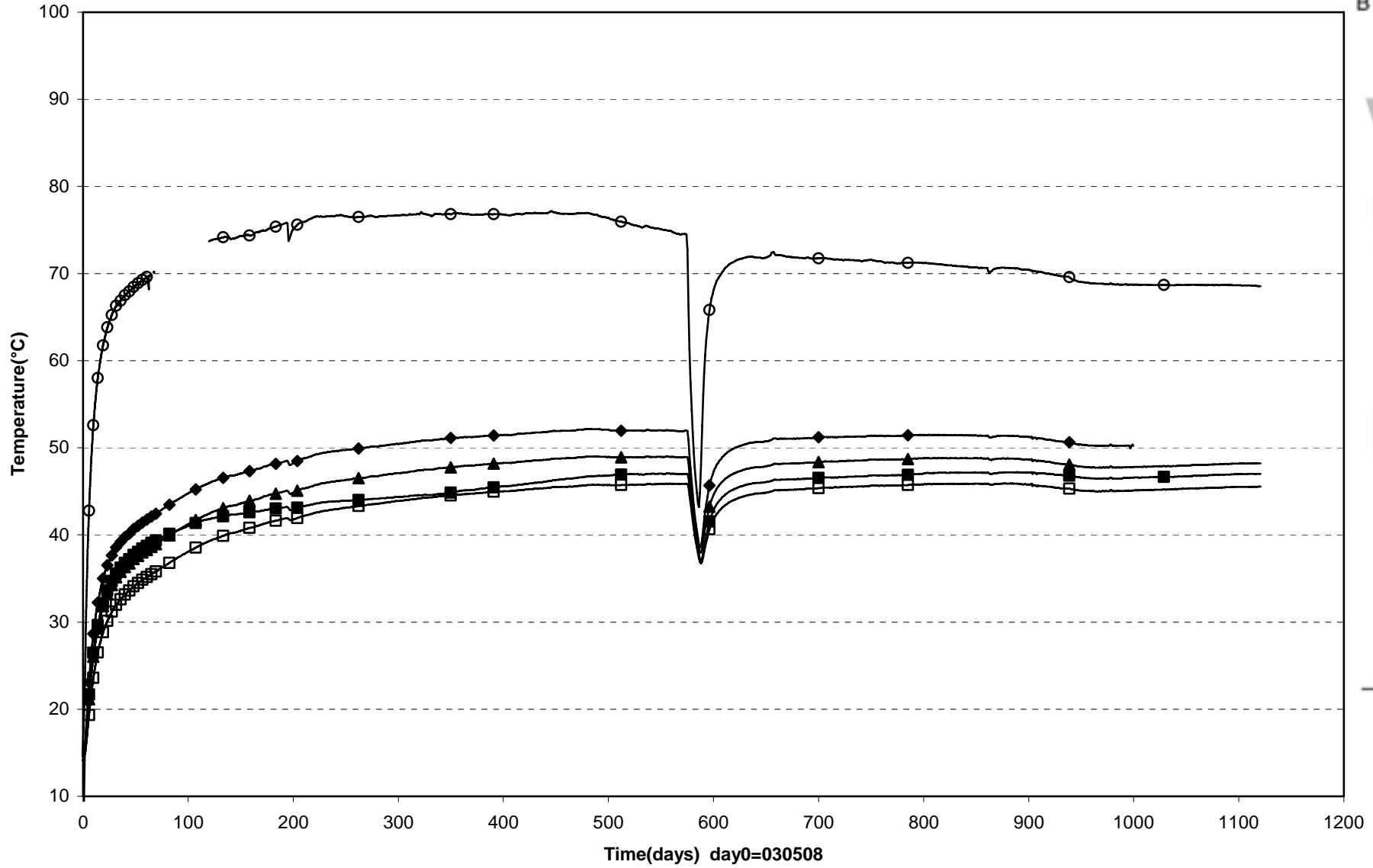
Prototype\Hole 5 \Ring5 (030508-060601)  
 Temperature - Pentronic



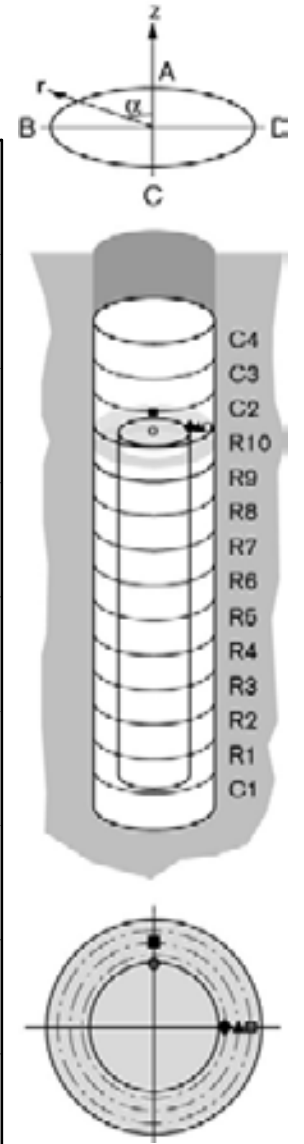
PrototypeHole 5 \Ring5 (030508-060601)  
 Temperature - Pentronic



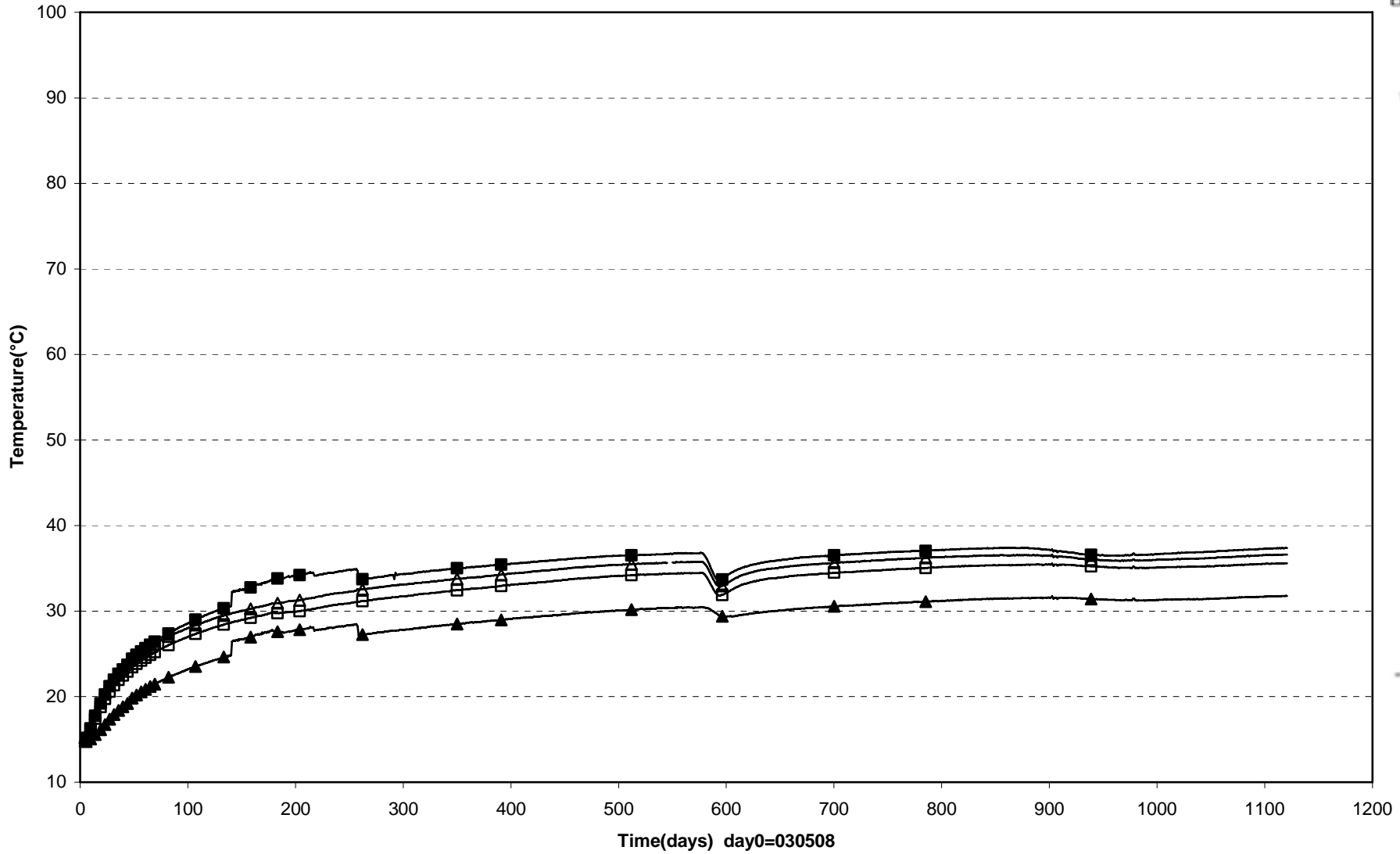
Prototype\Hole 5 \Ring10 (030508-060601)  
 Temperature - Pentronic



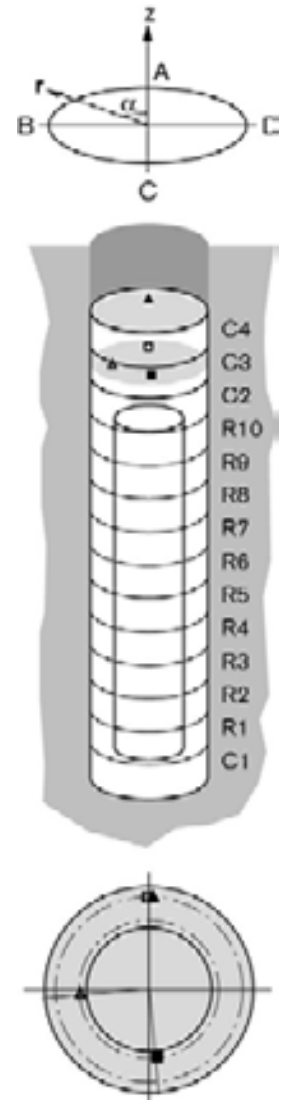
○ TB524(5.150\ 0°\0.525) ■ TB525(5.543\ 0°\0.685) ◆ TB526(5.543\ 270°\0.585) ▲ TB527(5.543\ 270°\0.685) □ TB528(5.543\ 270°\0.785)



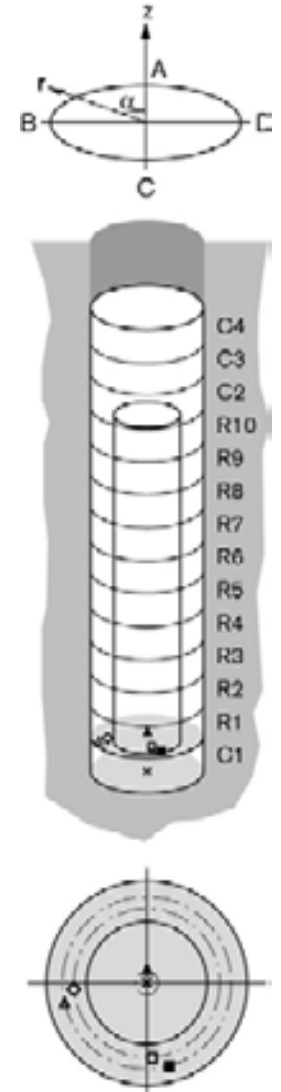
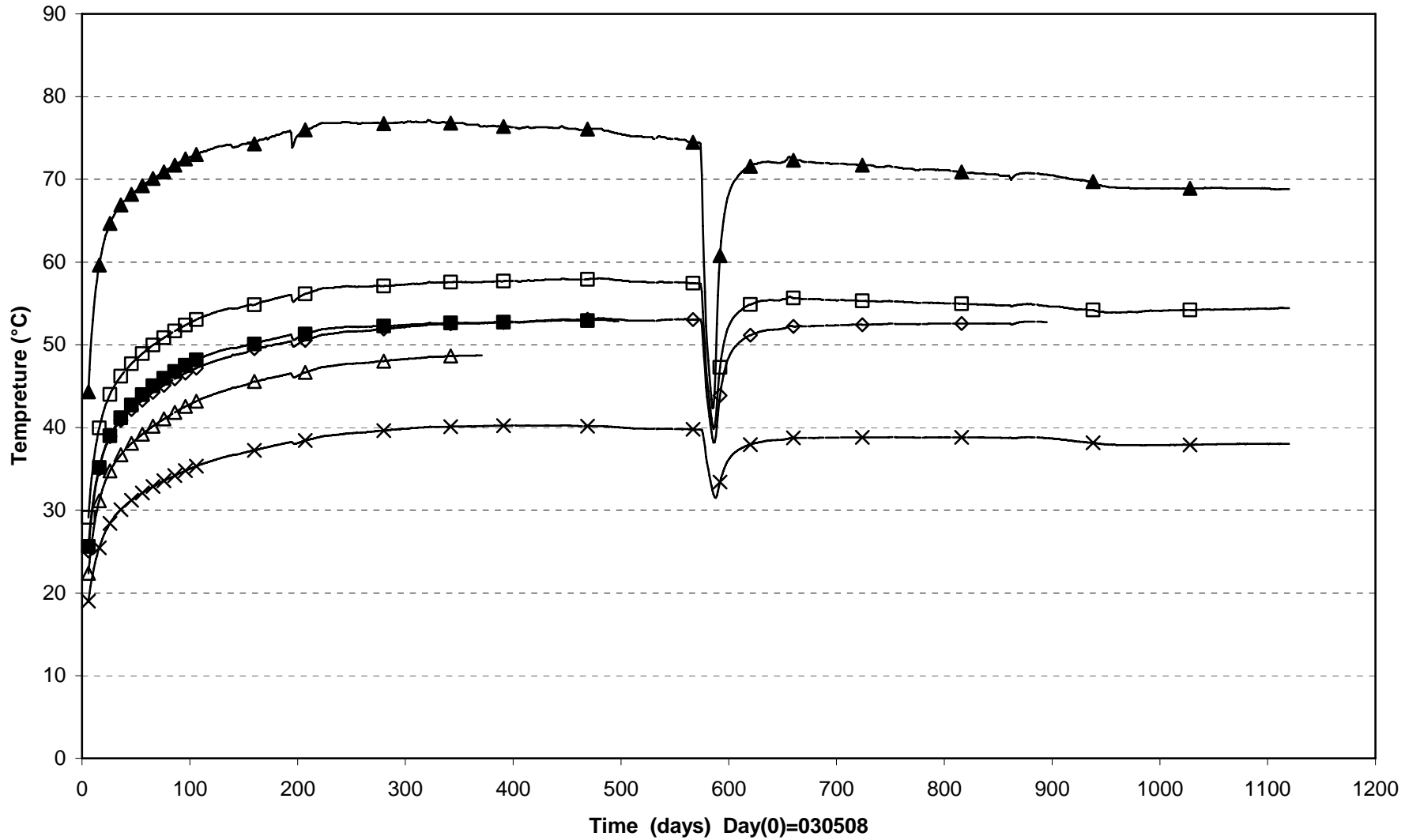
Prototype\Hole 5 \Cyl.3 and Cyl.4 (030508-060601)  
 Temperature - Pentronic



□ TB529(6.353\ 0°\0.785)    △ TB530(6.353\ 95°\0.585)    ■ TB531(6.353\ 185°\0.585)    ▲ TB532(7.060\ 0°\0.785)

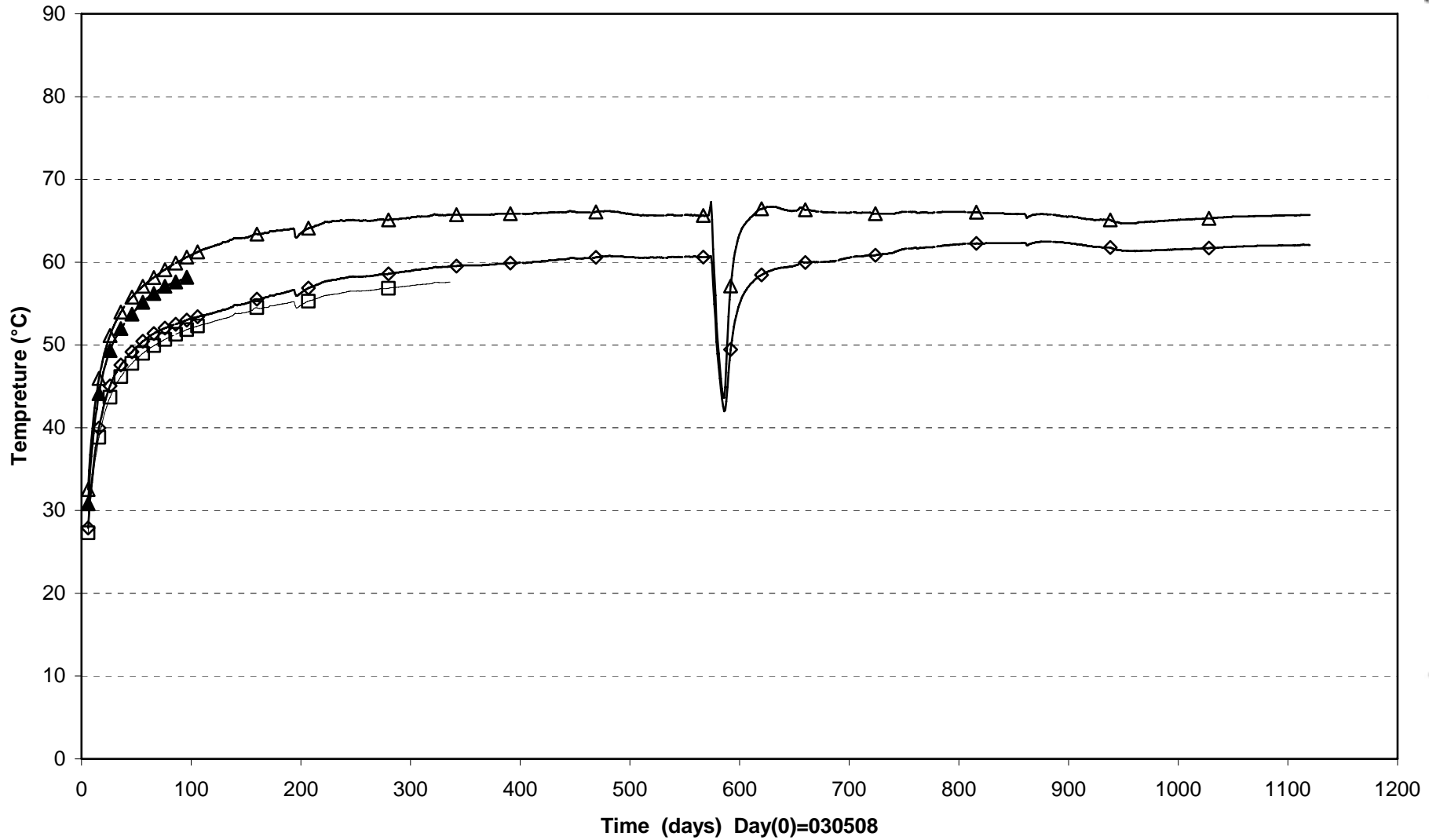


Prototype\Hole 5\Cyl.1 (030508-060601)  
 Temperature - Geokon

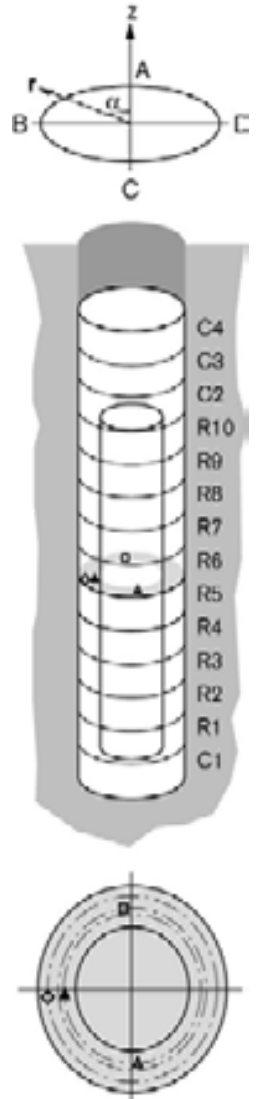


X PB501T(0\0°\0)	▲ PB502T(0.500\0°\0.100)	◇ PB506T(0.500\95°\0.635)
Δ PB507T(0.500\105°\0.735)	□ PB508T(0.500\185°\0.635)	■ PB509T(0.500\195°\0.735)

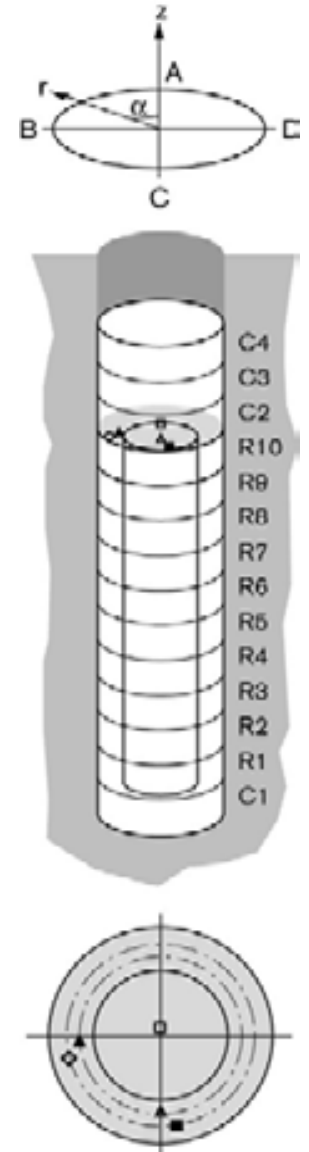
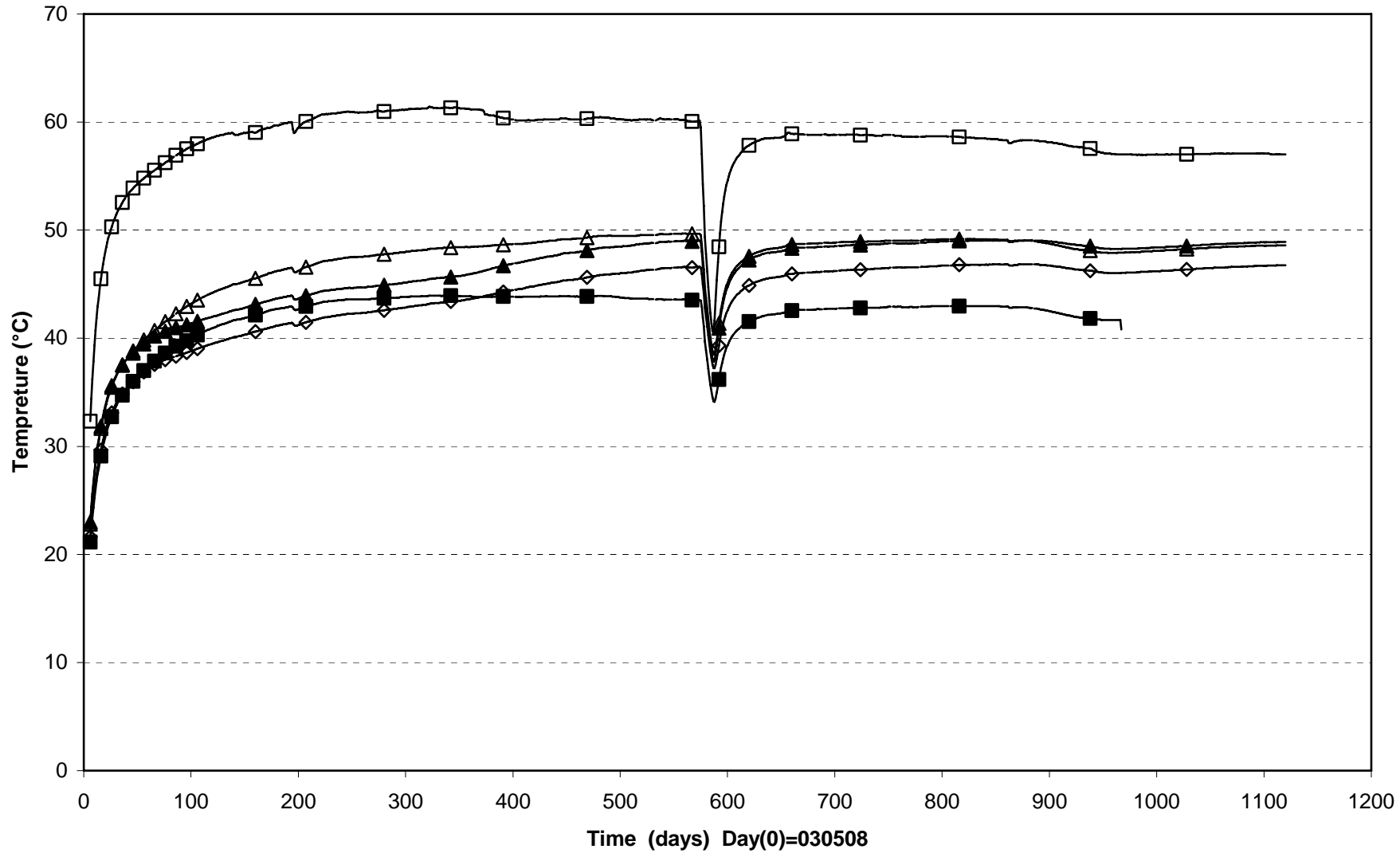
Prototype\Hole 5\Ring5 (030508-060601)  
 Temperature - Geokon



□ PB511T(3.036\5°\0.685)	▲ PB513T(3.036\95°\0.635)
◇ PB514T(3.036\95°\0.785)	△ PB515T(3.036\185°\0.635)

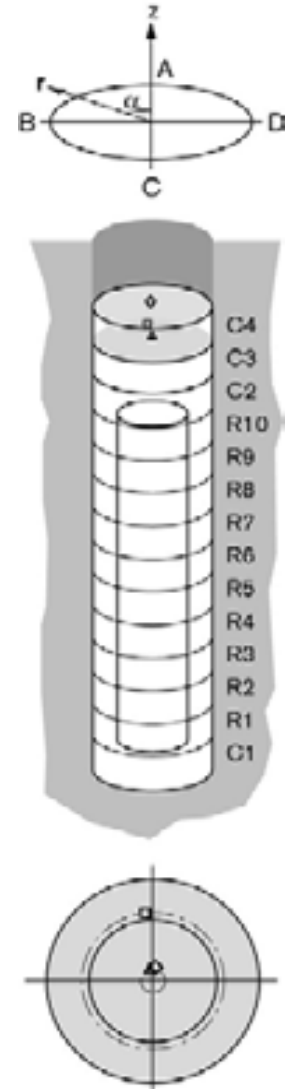
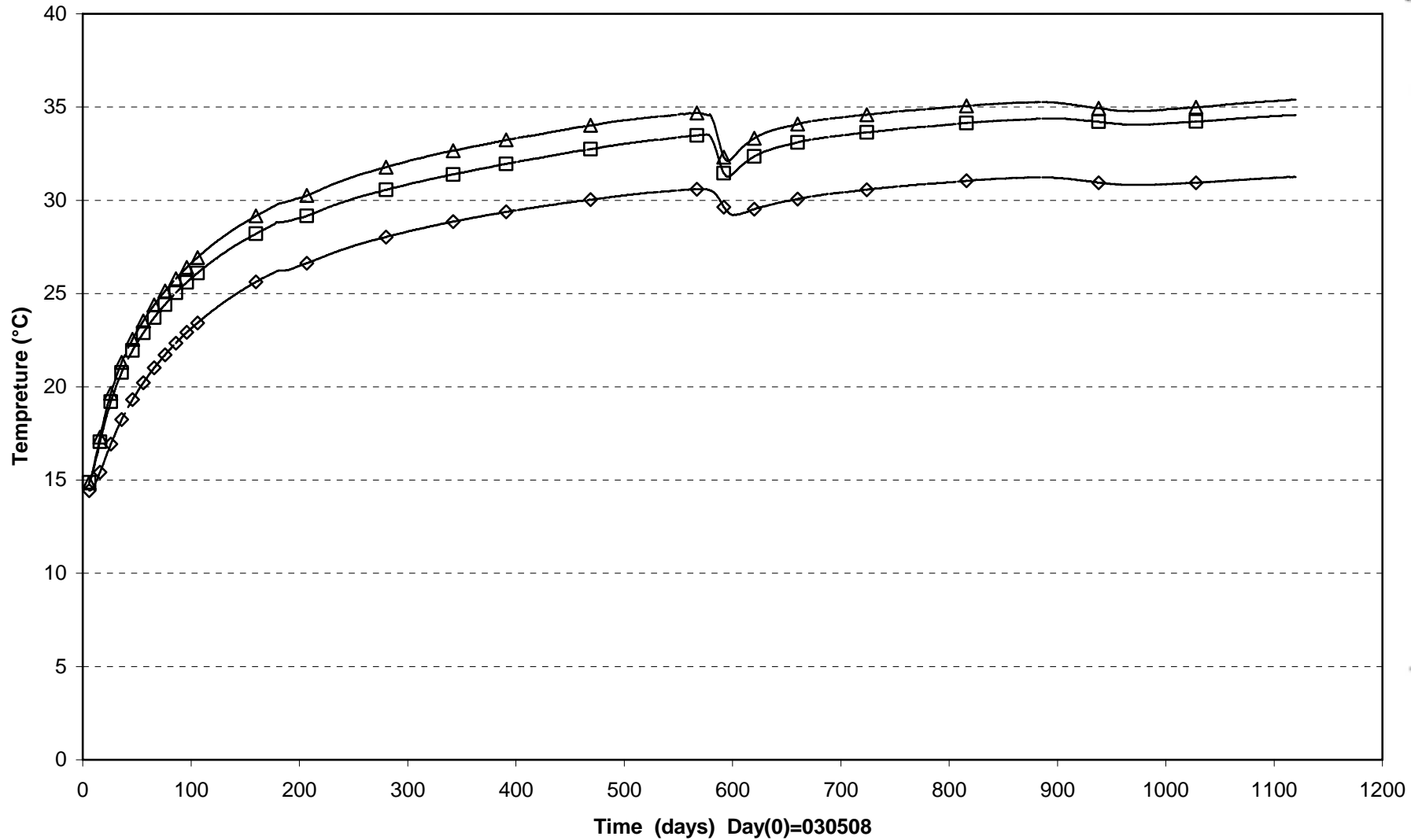


Prototype\Hole 5\Ring10 (030508-060601)  
 Temperature - Geokon



□ PB517T(5.593\0°\0.050)	▲ PB521T(5.593\95°\0.635)	◇ PB522T(5.593\105°\0.735)
△ PB523T(5.593\180°\0.635)	■ PB524T(5.593\190°\0.735)	

Prototype\Hole 5\Cyl.3 and Cyl.4 (030508-060601)  
 Temperature - Geokon



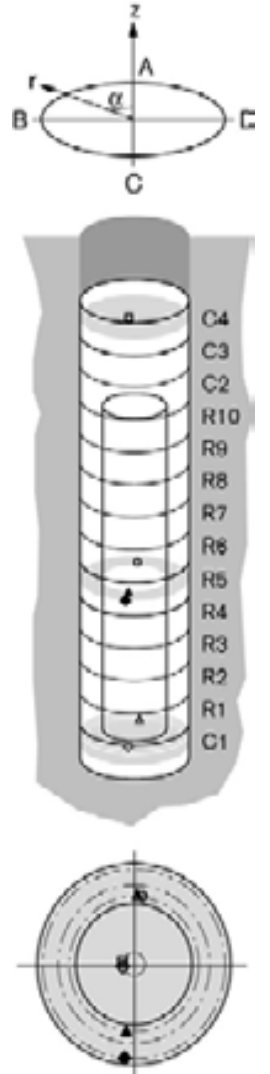
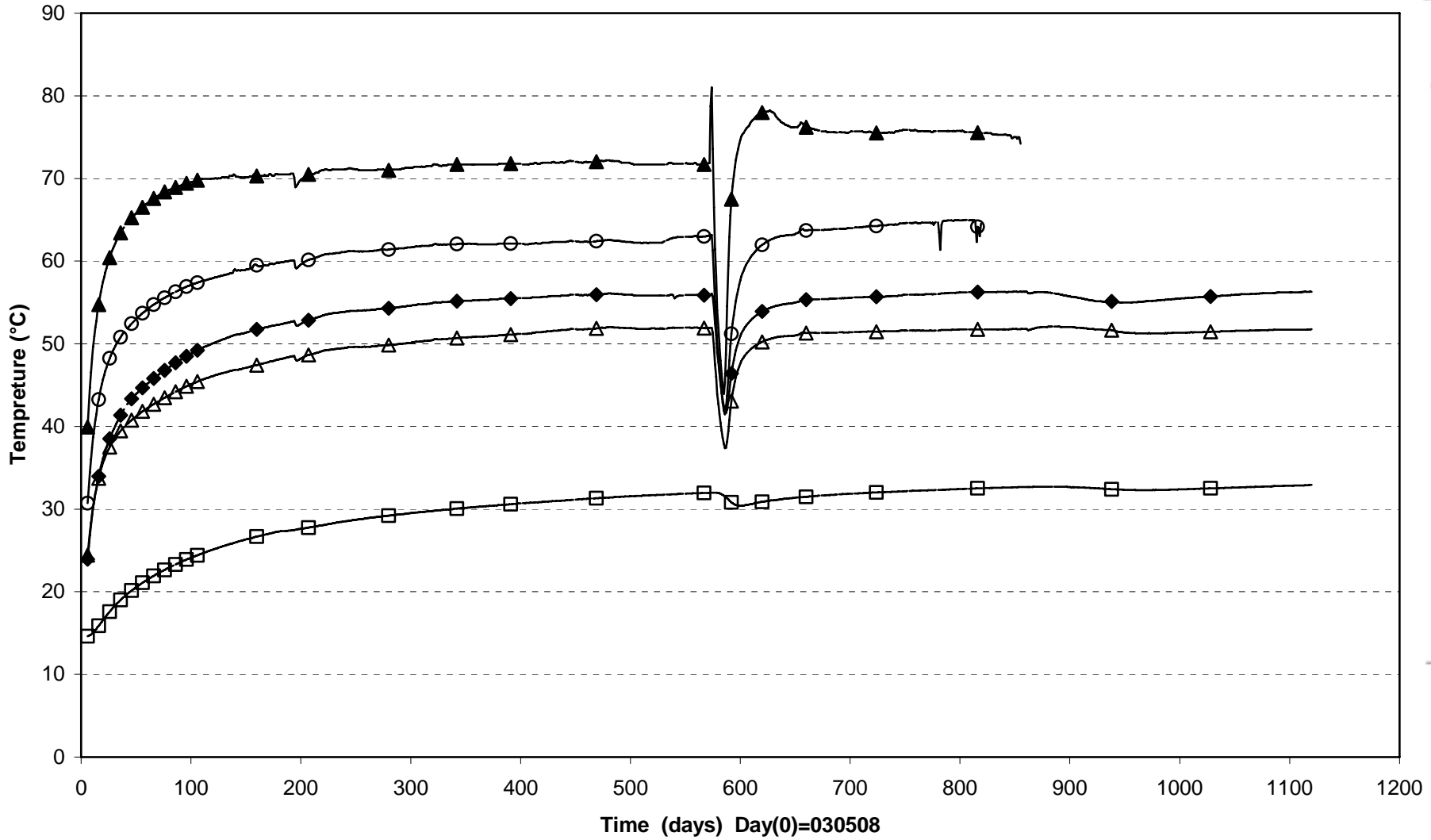
△ PB525T(6.603\0°\0.100)
 

□ PB526T(6.603\5°\0.585)
 

◇ PB527T(7.110\0°\0.100)

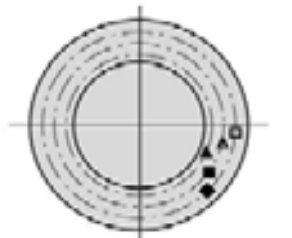
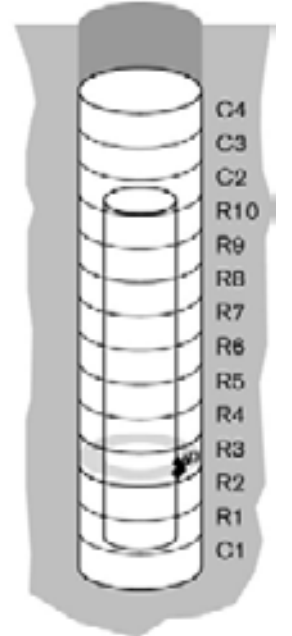
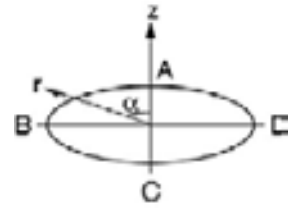
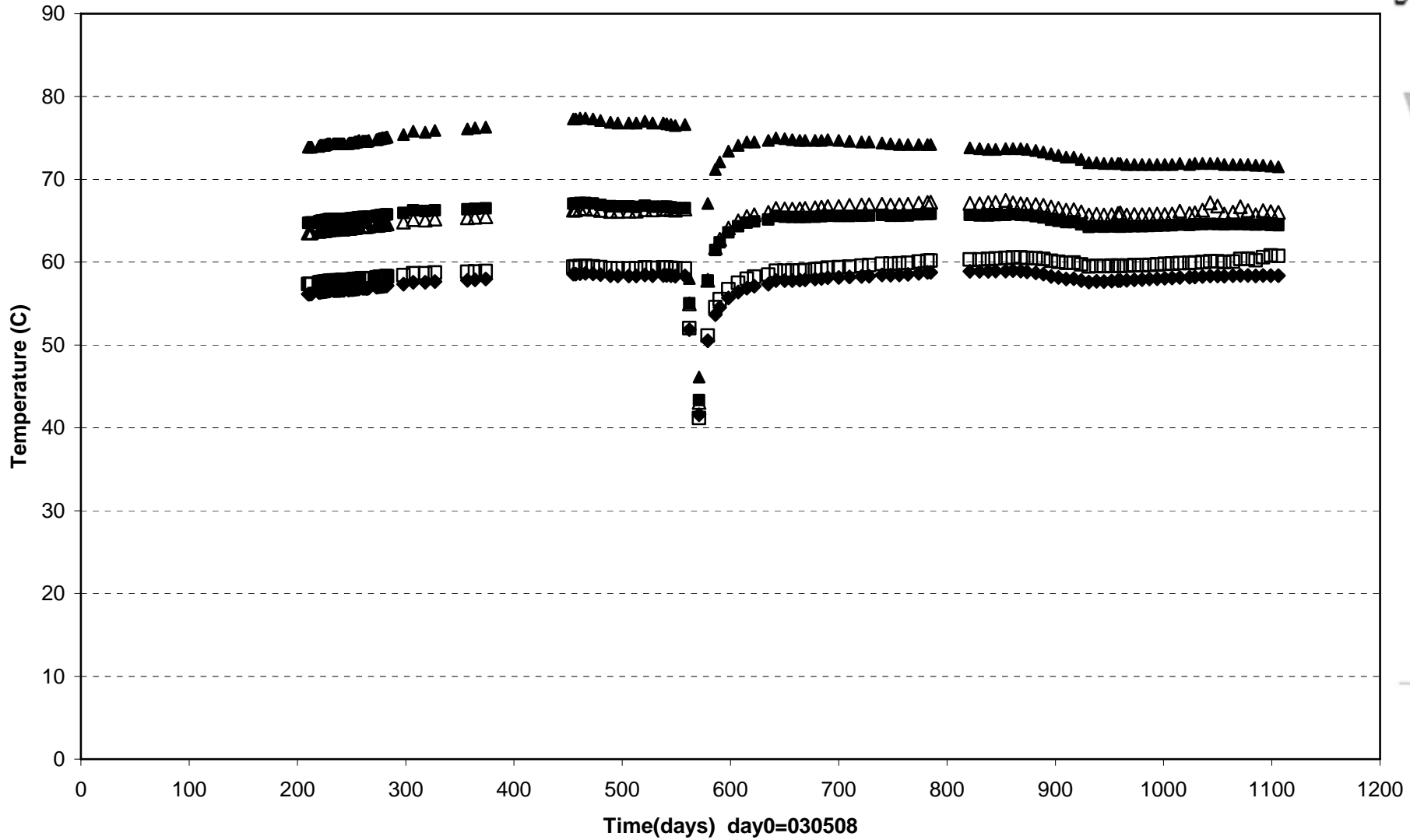


Prototype\Hole5 (030508-060601)  
Temperature - Geokon



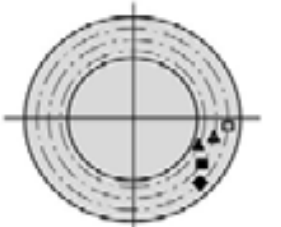
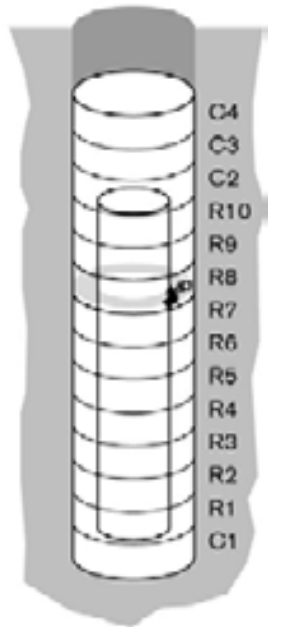
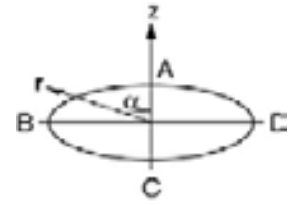
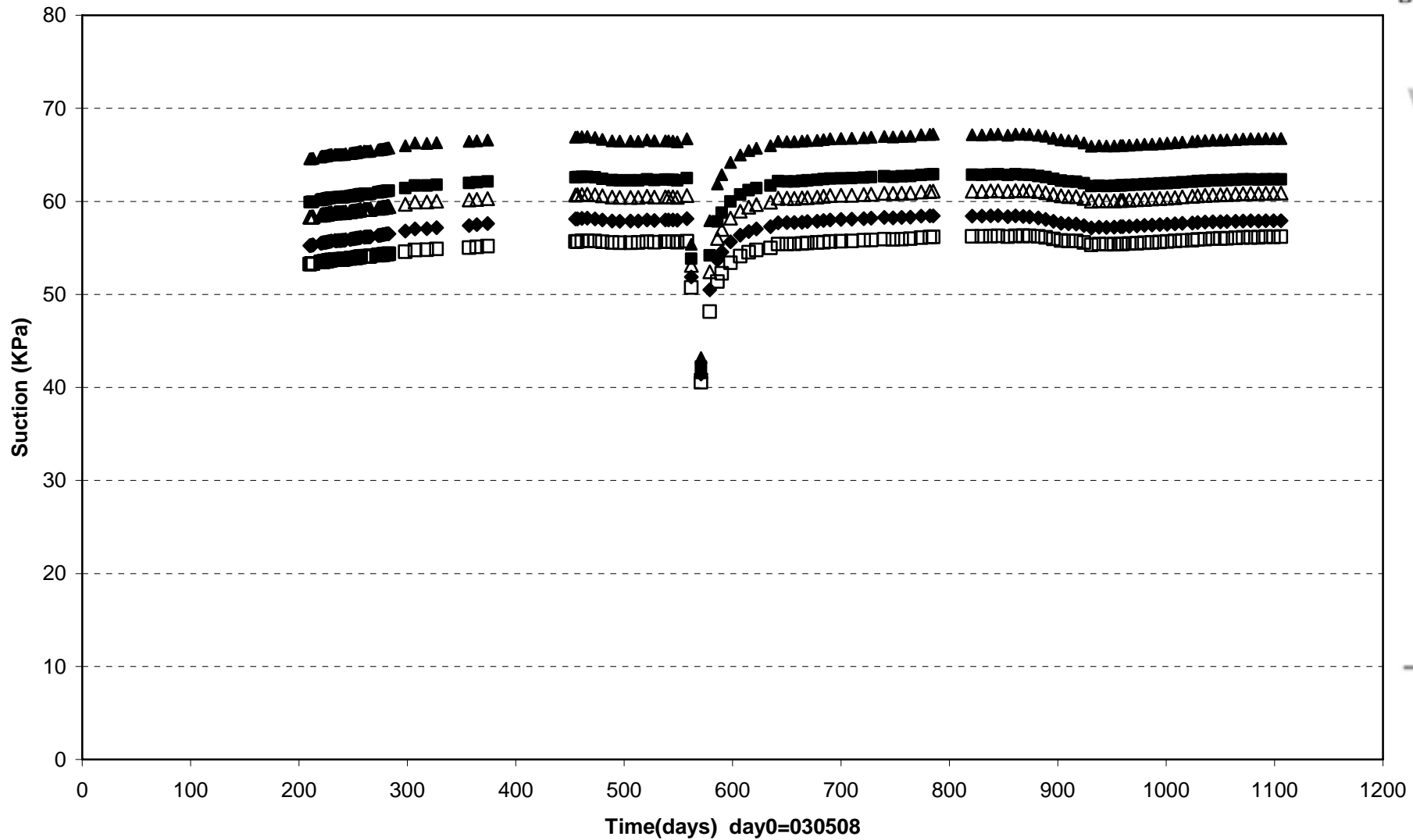
◇ UB502T(0.050\90°\0.100)	△ UB503T(0.250\355°\0.585)	○ UB505T(2.786\355°\0.585)
▲ UB509T(2.786\175°\0.535)	◆ UB510T(2.786\175°\0.825)	□ UB514T(6.860\90°\0.100)

Prototype\ Hole 5 \ Ring 3 (030508-060601)  
 Temperature - Wescor



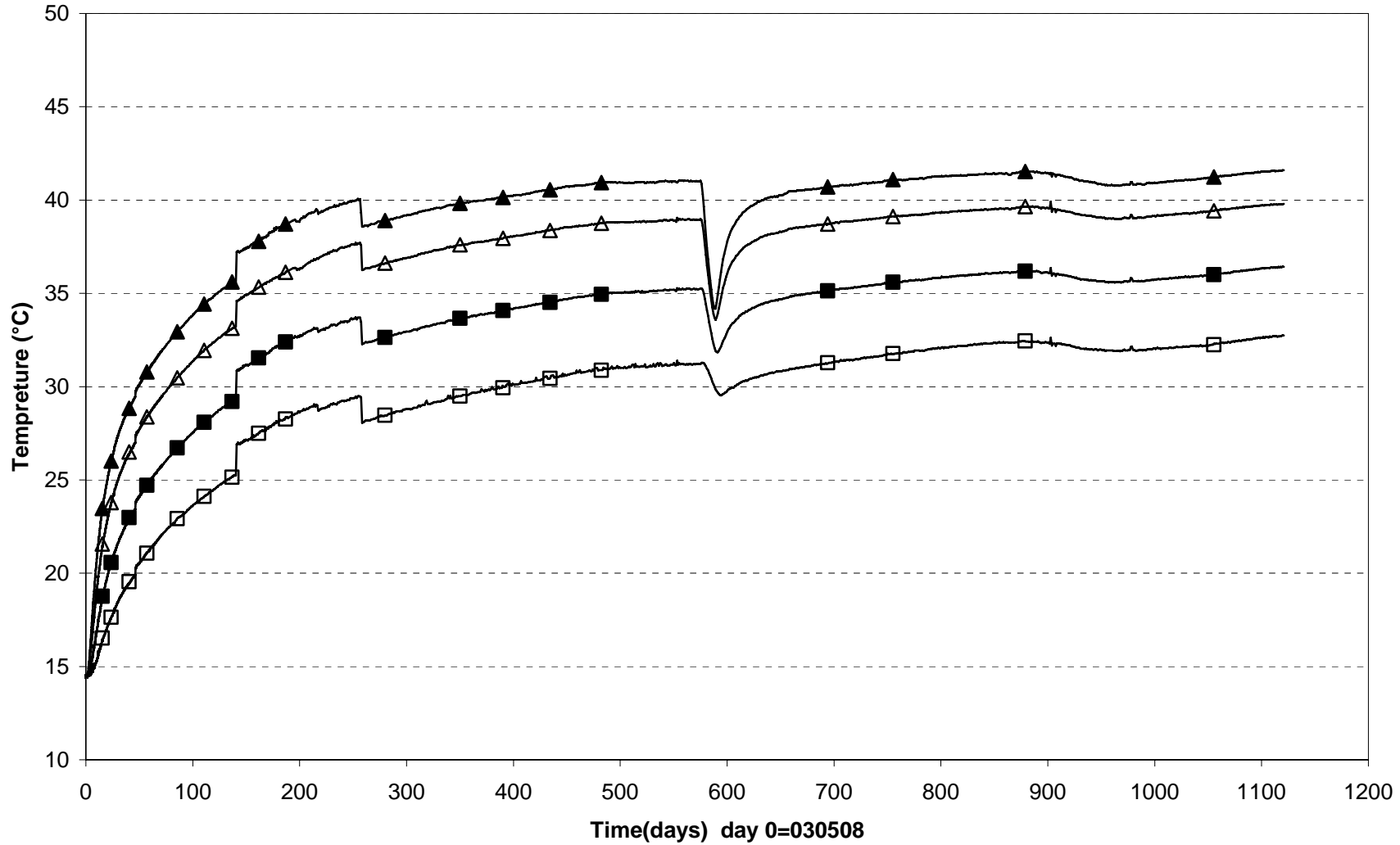
◆ WB538T(1.624\225°\0.775) ■ WB539T(1.624\235°\0.680) ▲ WB540T(1.624\245°\0.585) △ WB541T(1.624\255°\0.680) □ WB542T(1.624\265°\0.775)

Prototype\ Hole 5 \ Ring 8 (030508-060601)  
Suction - Wescor

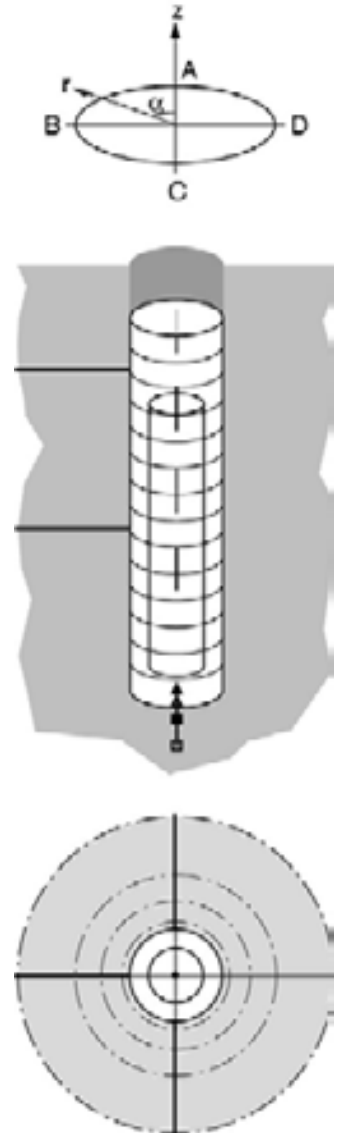


◆ WB543T(4.173\225°\0.775) ■ WB544T(4.173\235°\0.680) ▲ WB545T(4.173\245°\0.585) ▾ WB546T(4.173\255°\0.680) □ WB547T(4.173\265°\0.775)

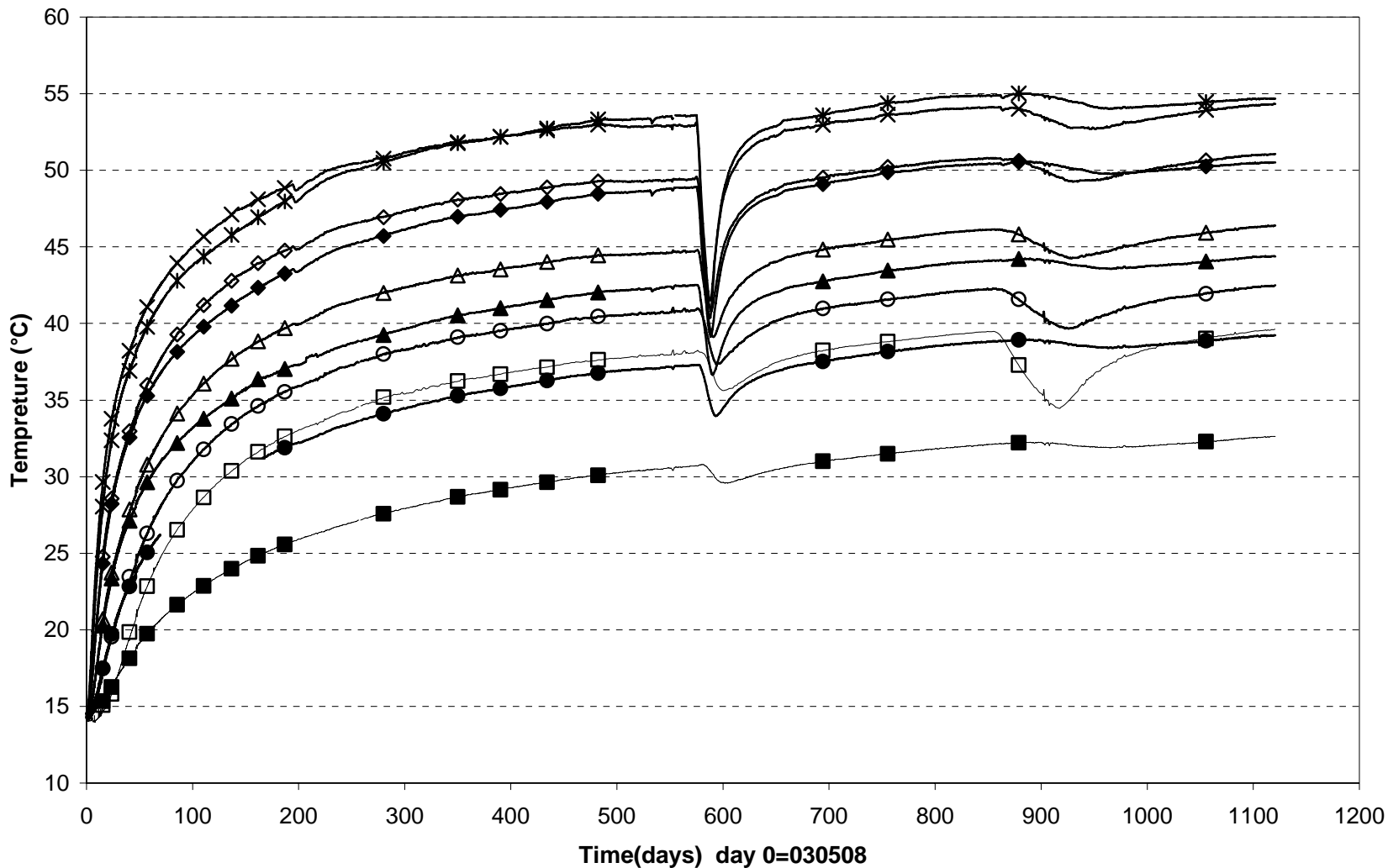
Prototype\Rock\Hole 5\ Bottom (030508-060601)  
 Temperature - Pentronic



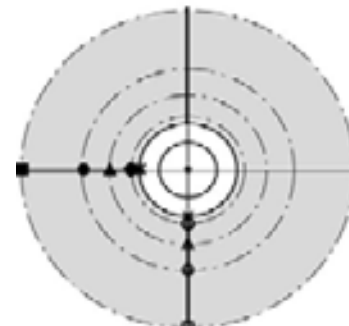
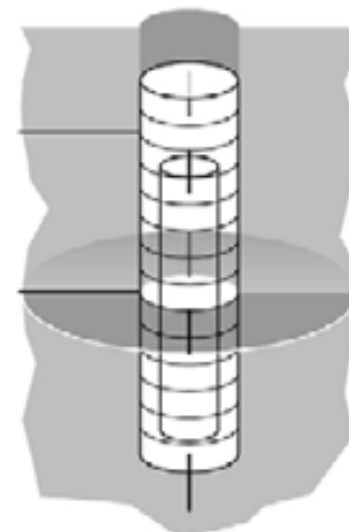
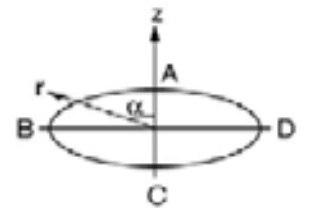
□ TR5011(-1,0\0°\0,0\Bottom) ■ TR5012(-0,5\0°\0,0\Bottom) △ TR5013(-0,2\0°\0,0\Bottom) ▲ TR5014(0,0\0°\0,0\Bottom)



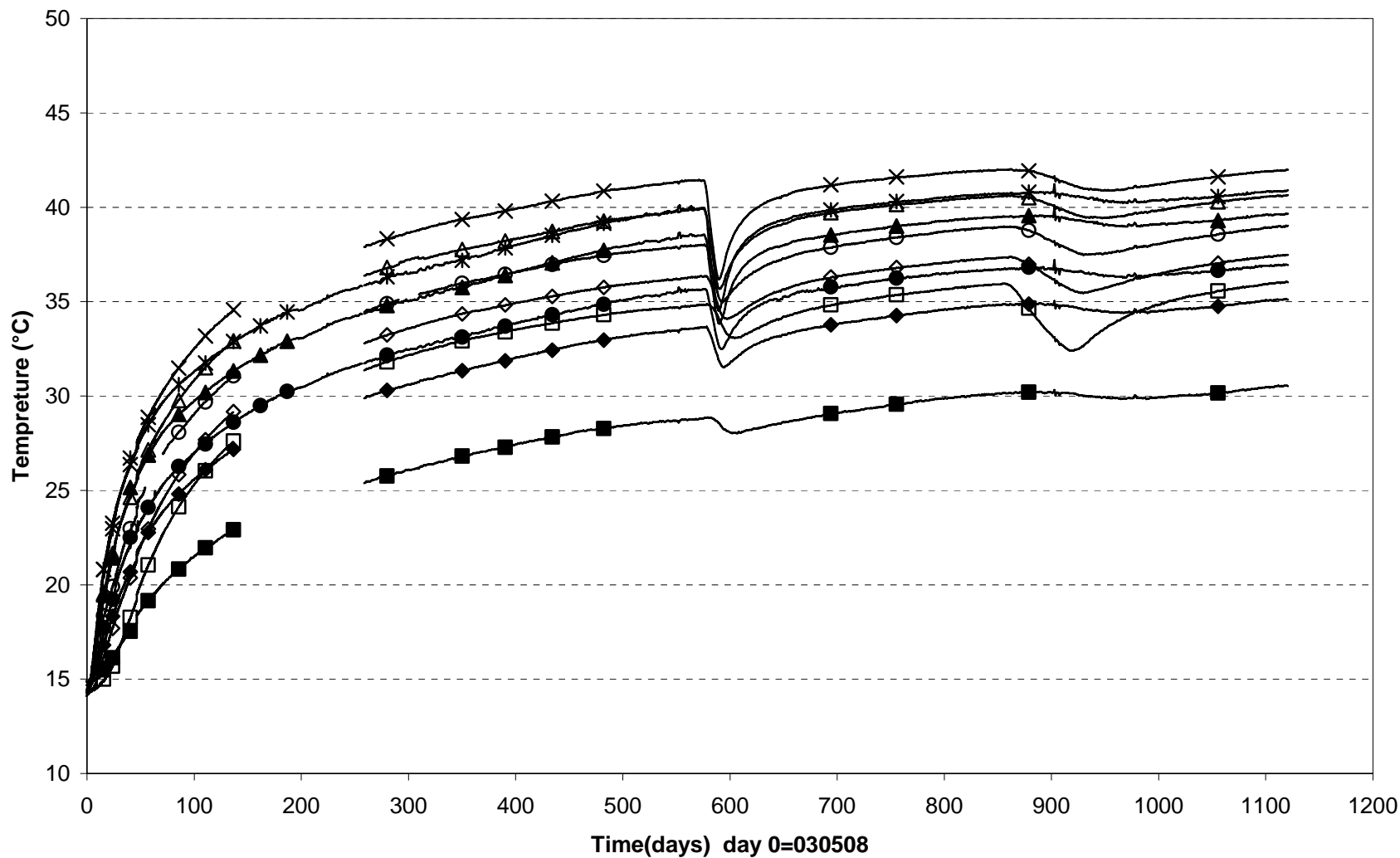
Prototype\Rock\Hole 5 \Level 3,0 m (030508-060601)  
 Temperature - Pentronic



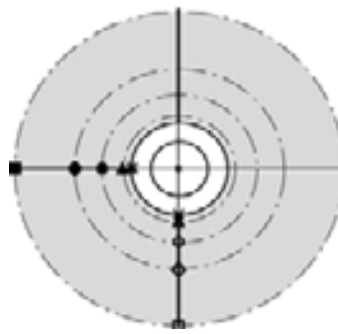
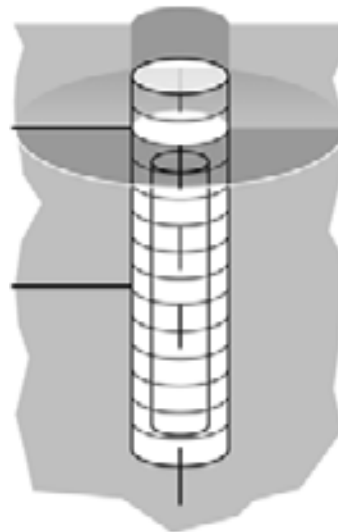
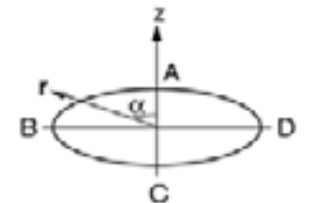
- TR5041 (3,0\170°\3,075)    ○ TR5042 (3,0\170°\1,975)    △ TR5043 (3,0\170°\1,475)    ◇ TR5044 (3,0\170°\1,075)    × TR5045 (3,0\170°\0,875)
- TR5051 (3,0\80°\3,075)    ● TR5052 (3,0\80°\1,975)    ▲ TR5053 (3,0\80°\1,475)    ◆ TR5054 (3,0\80°\1,075)    ✱ TR5055 (3,0\80°\0,875)



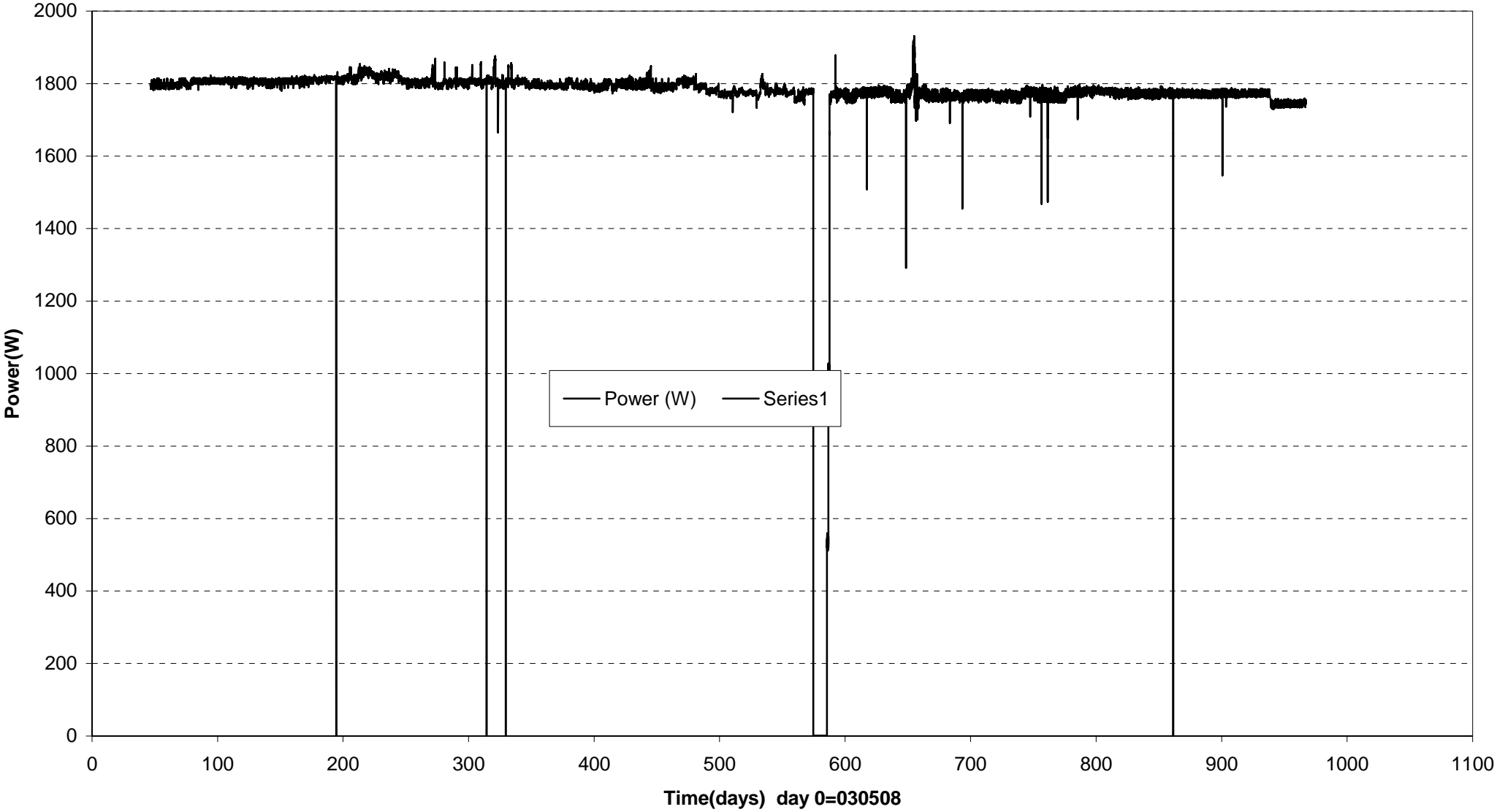
Prototype\Rock\Hole 5 \Level 6,0 m (030508-060601)  
 Temperature - Pentronic



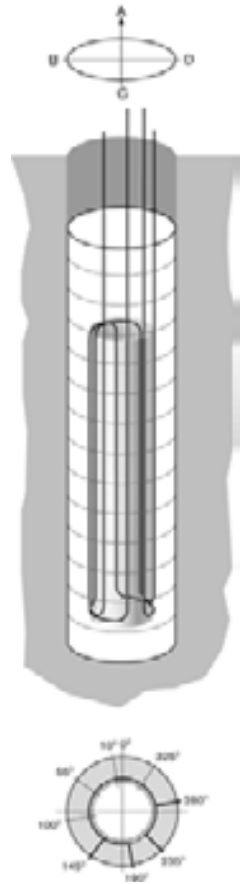
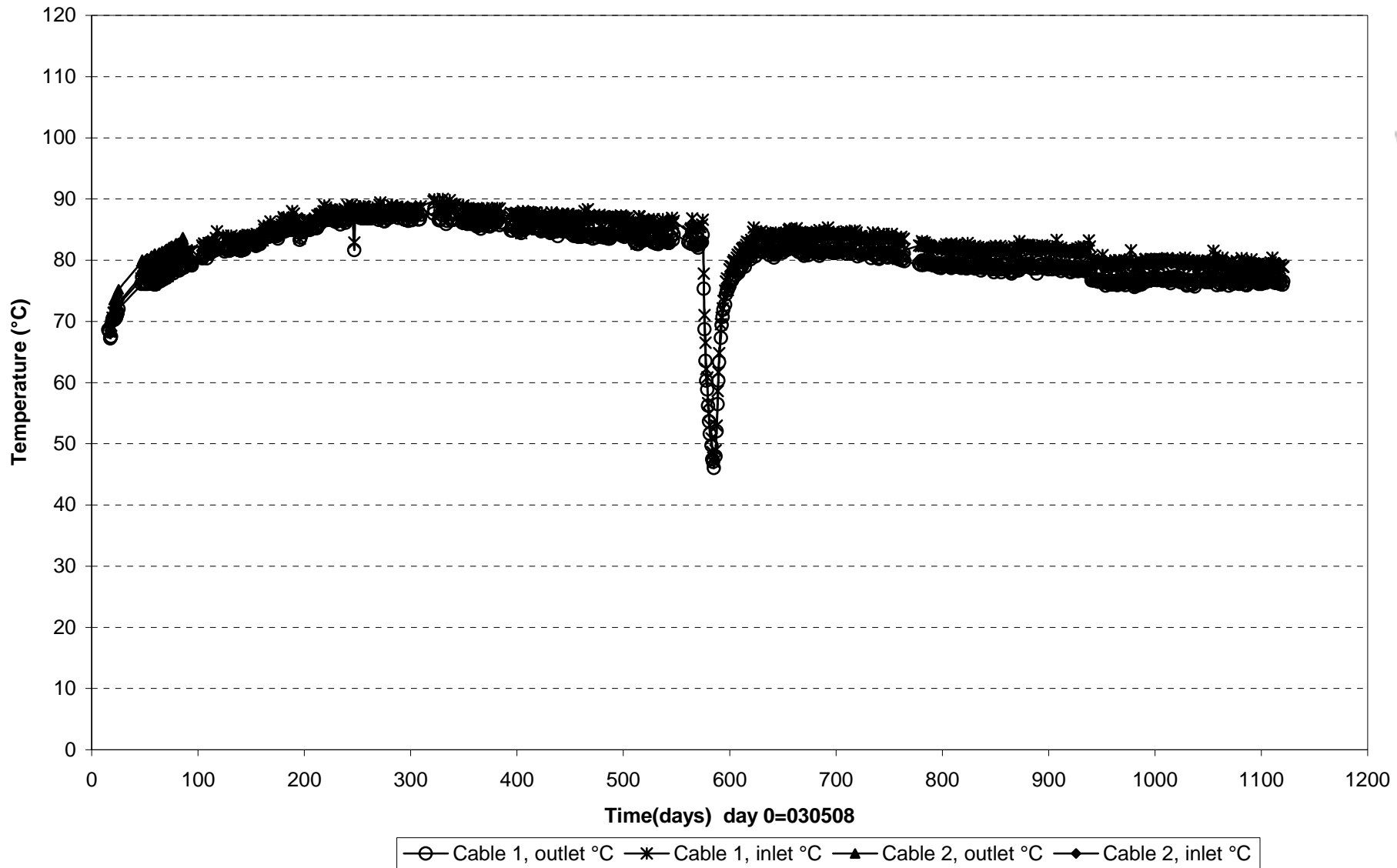
- TR5021 (6,0\171°\3,075)    ◇ TR5022 (6,0\171°\1,975)    ○ TR5023 (6,0\171°\1,475)    △ TR5024 (6,0\171°\1,075)    × TR5025 (6,0\171°\0,875)
- TR5031 (6,0\80°\3,075)    ◆ TR5032 (6,0\80°\1,975)    ● TR5033 (6,0\80°\1,475)    ▲ TR5034 (6,0\80°\1,075)    ✱ TR5035 (6,0\80°\0,875)



Prototype\Hole 5 (030508-060601)  
Canister power

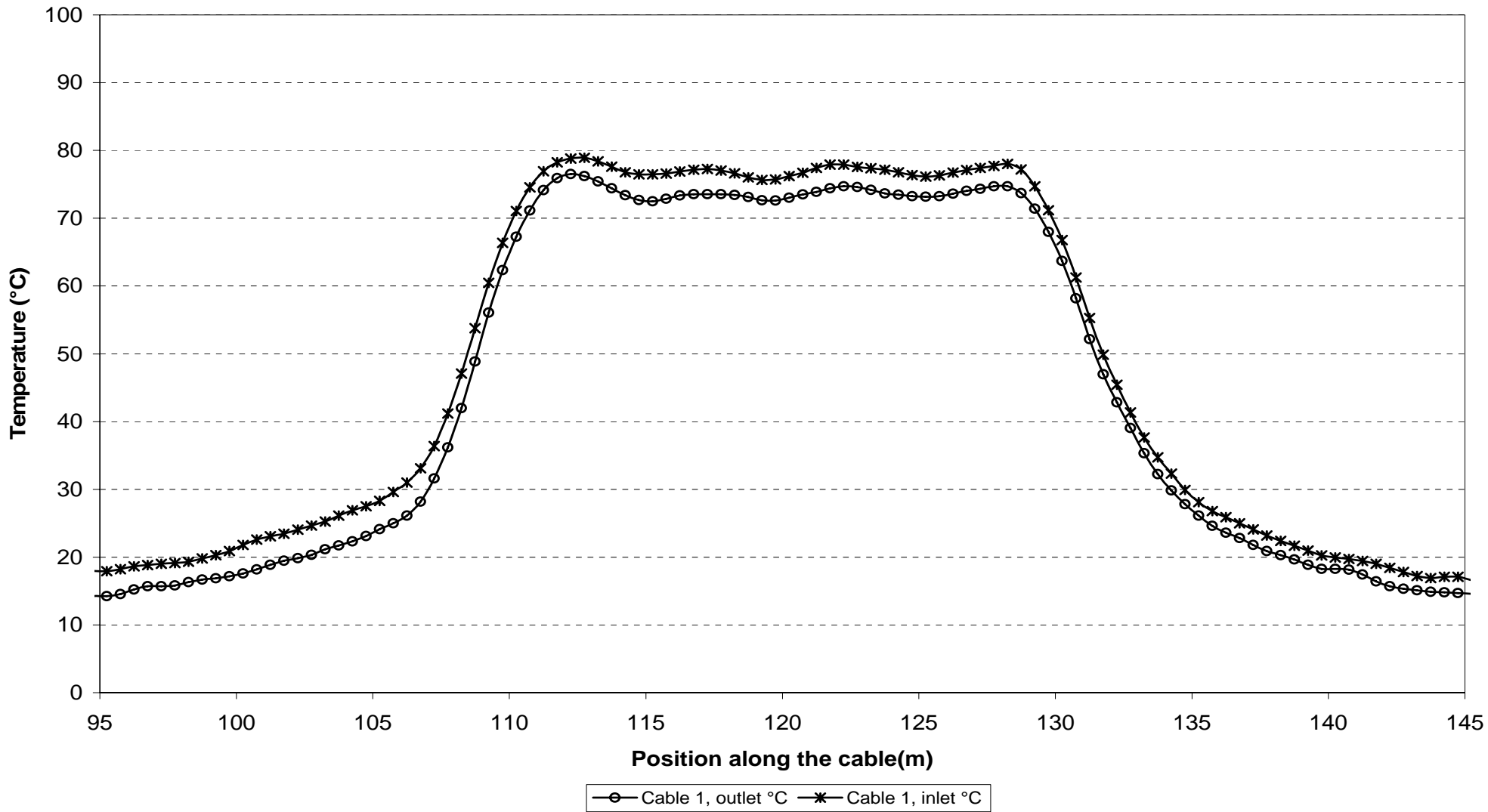


Prototype\ Hole 5 \Canister (030508-060601)  
 Max. temperature on the canister surface - Optical fiber cables

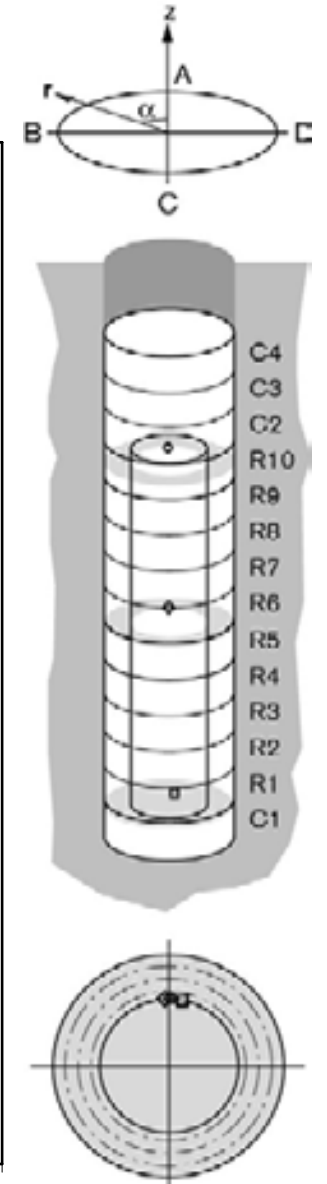
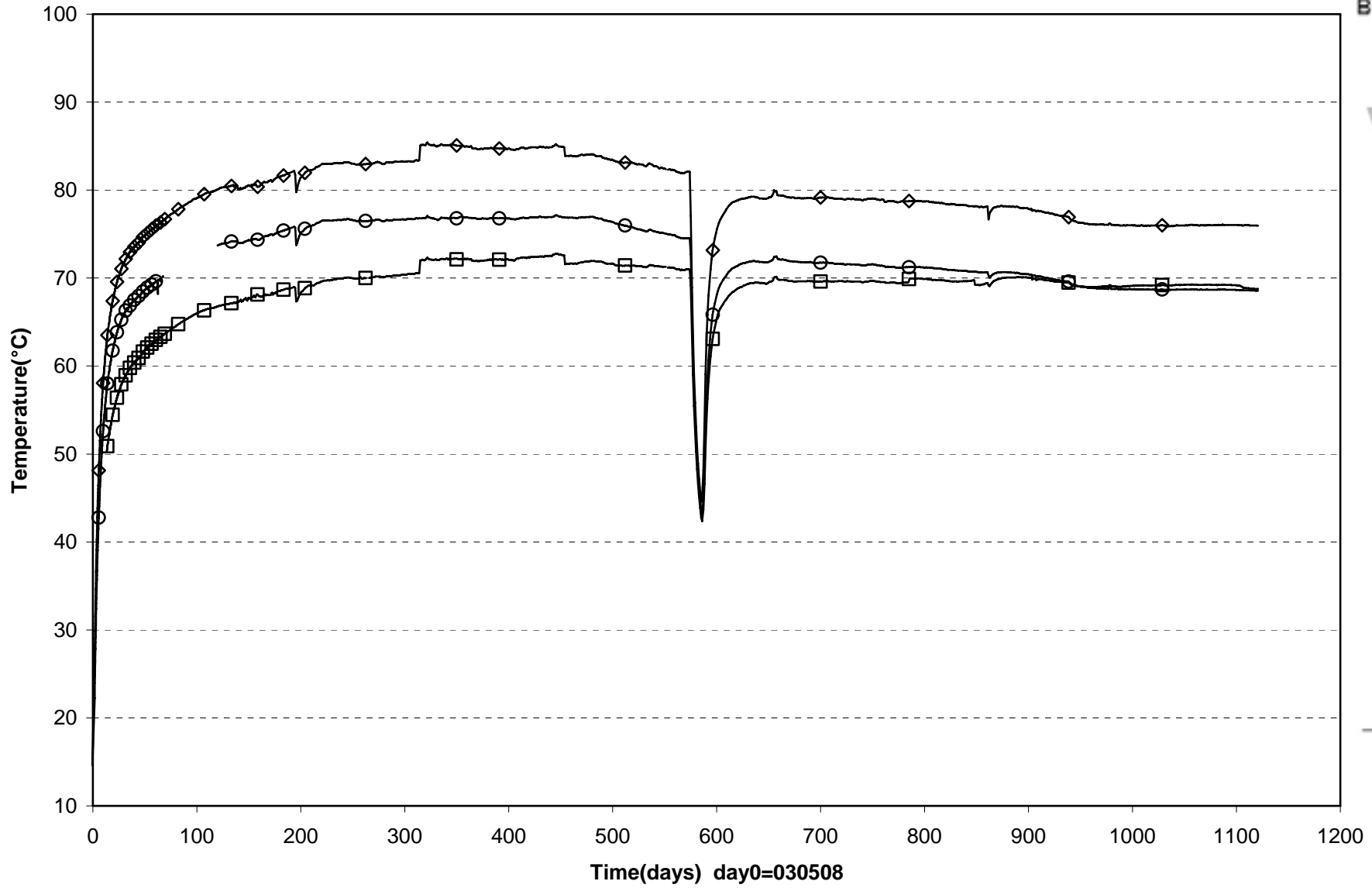




### Temperature profile on the canister surface-No5 (060601) Optical fiber cables



Prototype\Hole 5 \On the canister surface (030508-060601)  
 Temperature - Pentronic

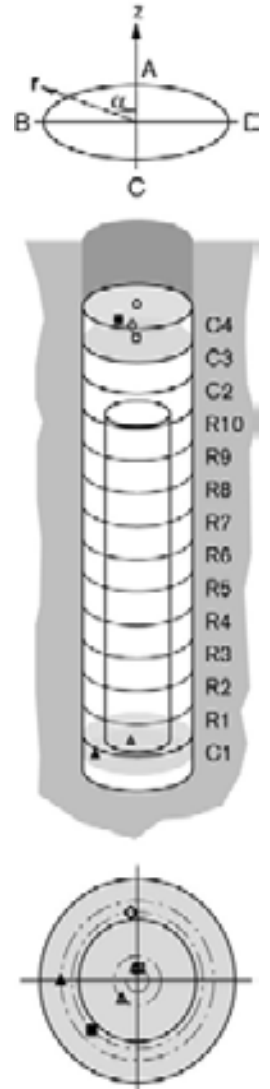
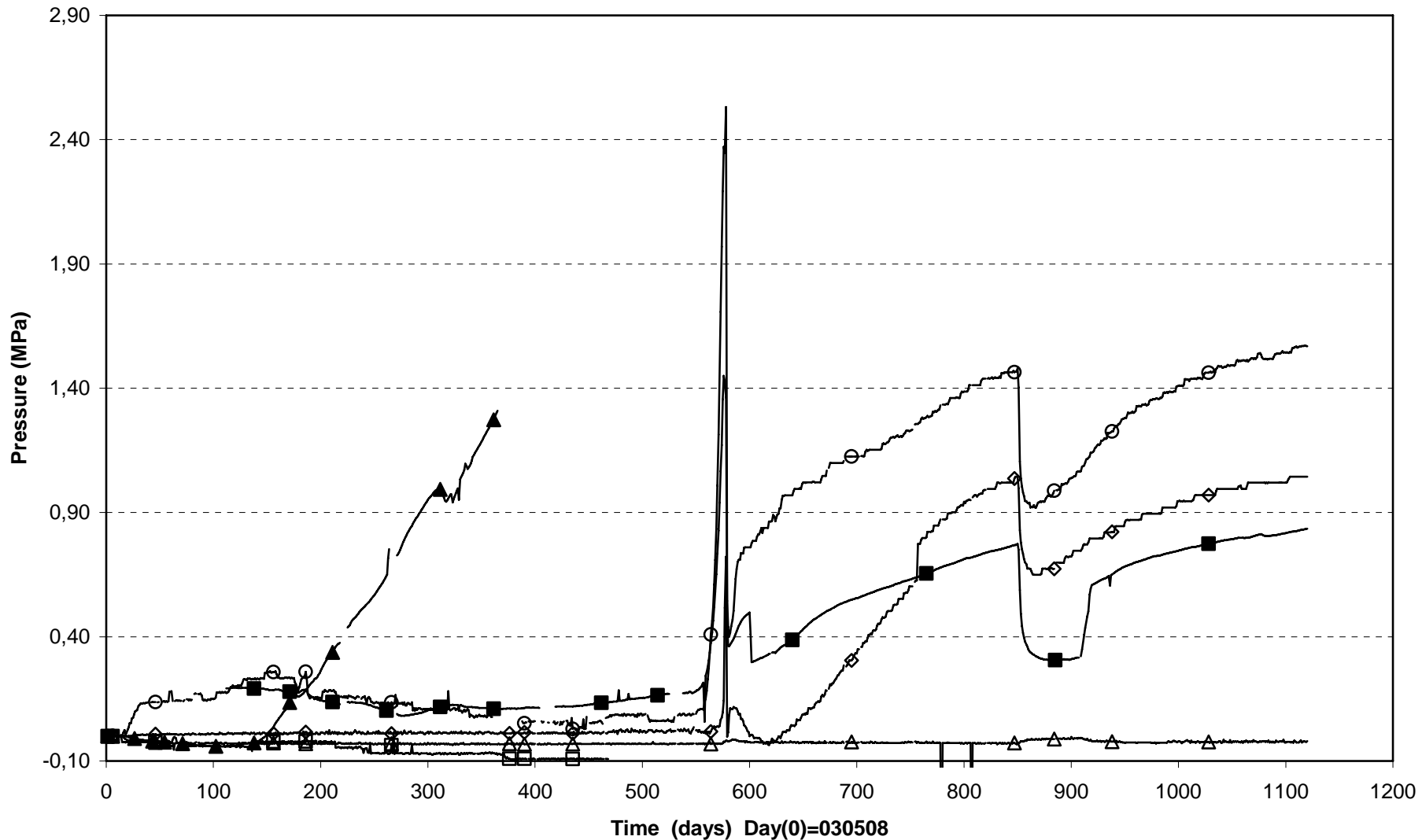


## **Appendix 6**

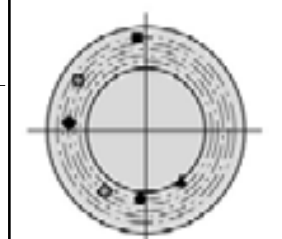
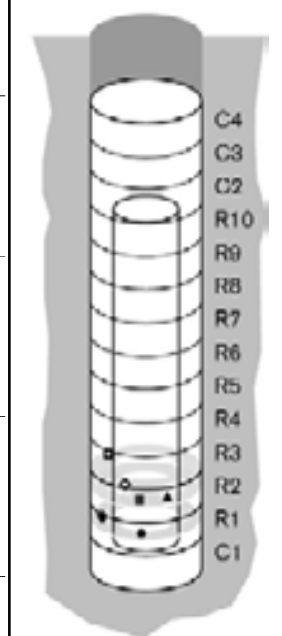
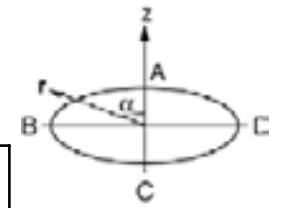
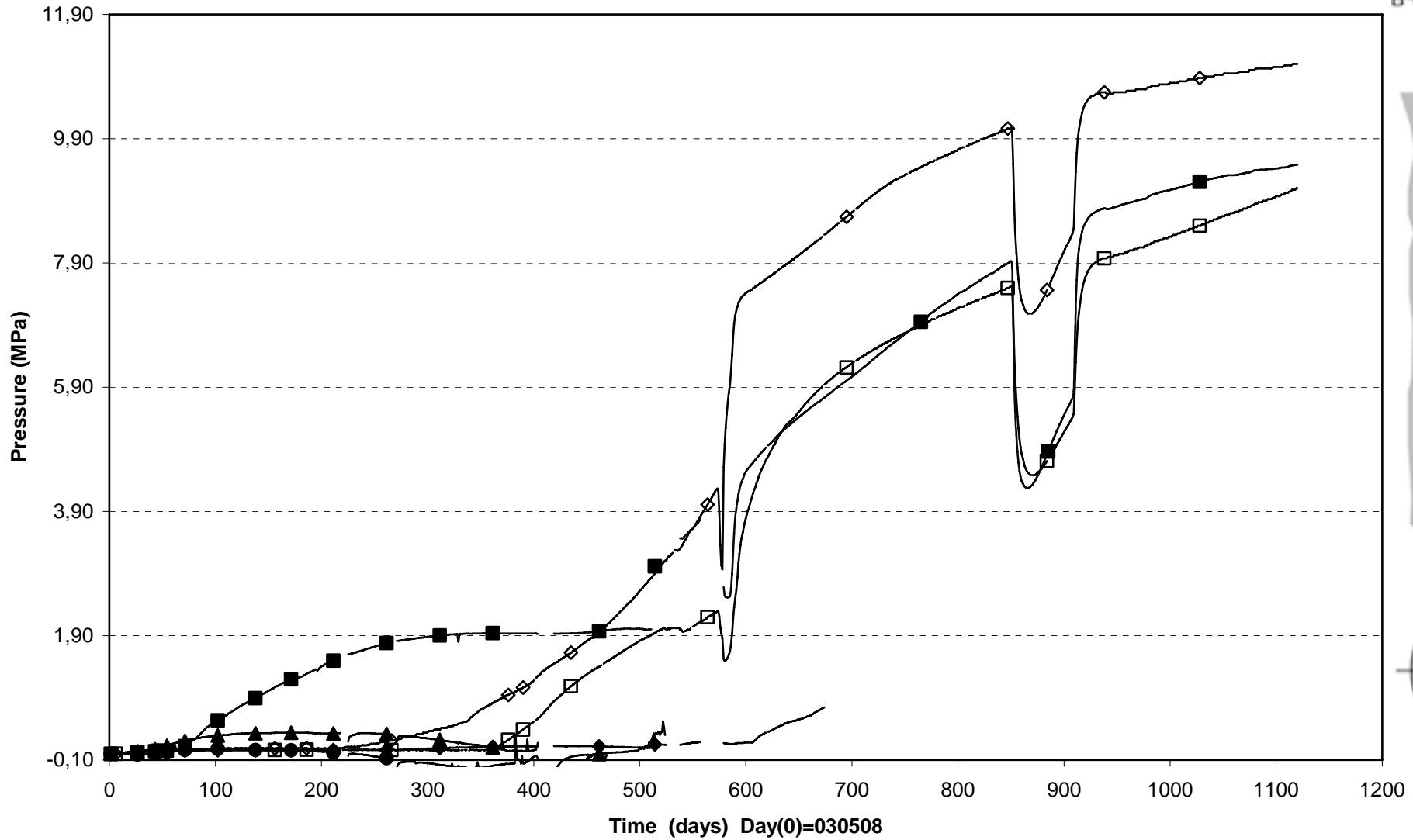
**Dep. hole 6**



Prototype\Hole 6\Cyl.1 , Cyl.2 and Cyl.3 (030508-060601)  
 Total pressure

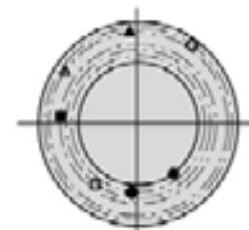
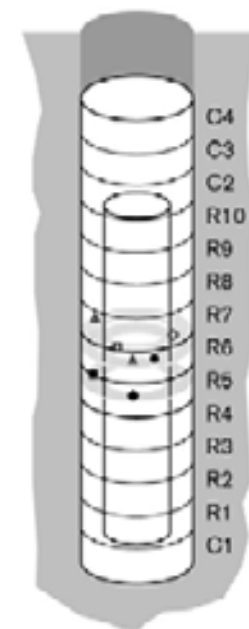
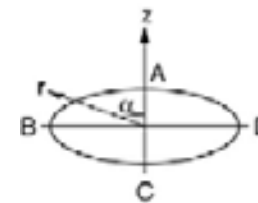
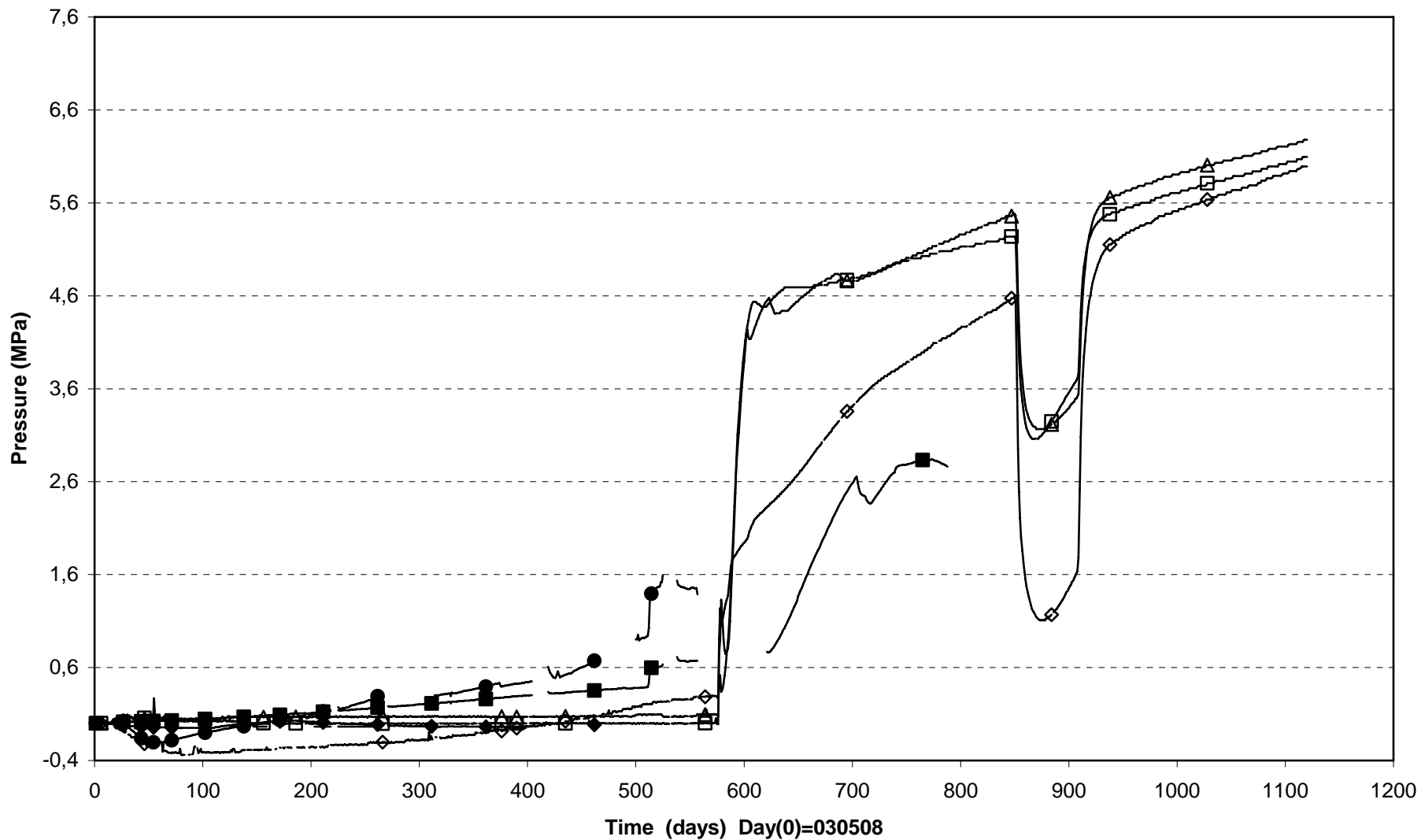


Prototype\Hole 6\ Ring1 and Ring 2 (030508-060601)  
Total pressure

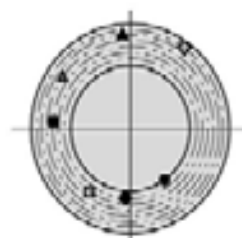
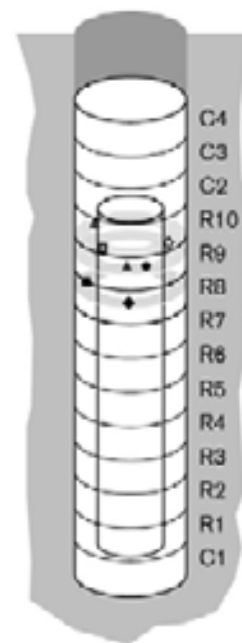
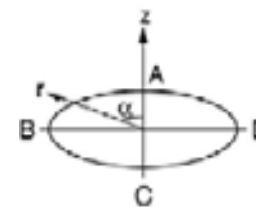
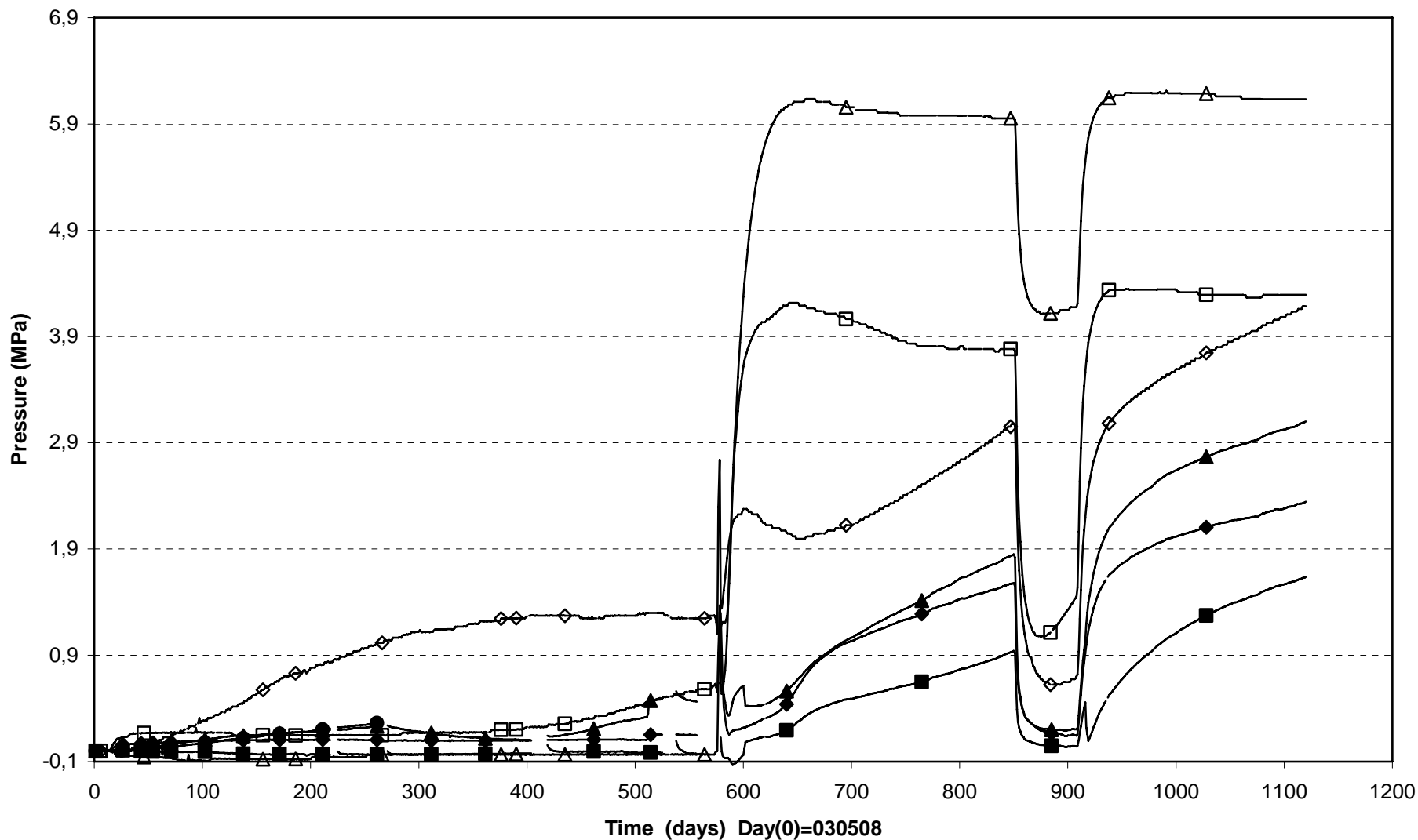


■ PB603(0.770 \10°\ 0.785)	◆ PB604(0.770 \80°\ 0.685)	● PB605(0.770 \170°\ 0.585)
□ PB606(1.534\55°\ 0.735)	◇ PB607(1.534\145°\ 0.635)	▲ PB608(1.284 \215°\ 0.535)

Prototype\Hole 6\ Ring 5 and Ring 6 (030508-060601)  
Total pressure

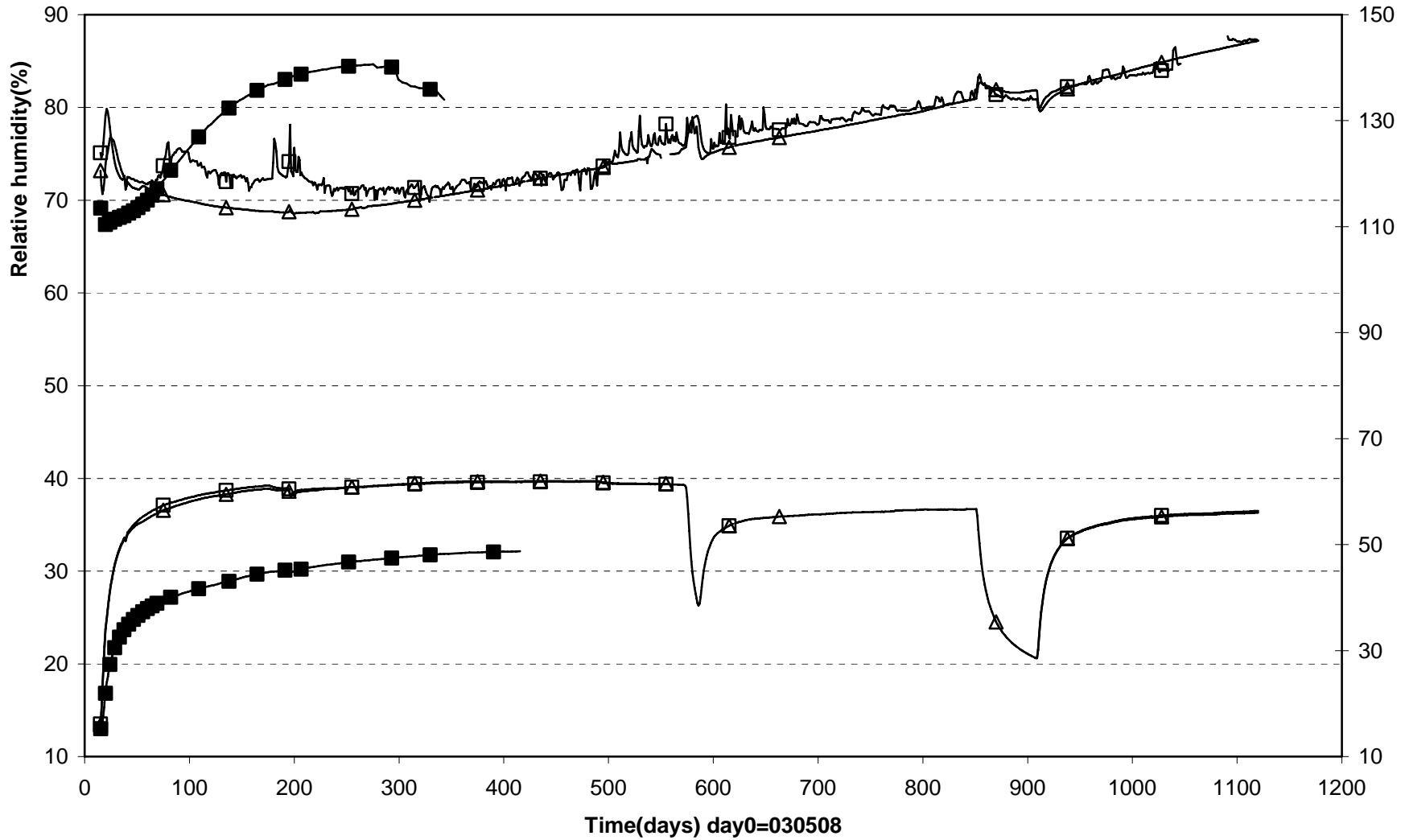


Prototype\Hole 6\ Ring 8 and Ring 9 (030508-060601)  
Total pressure

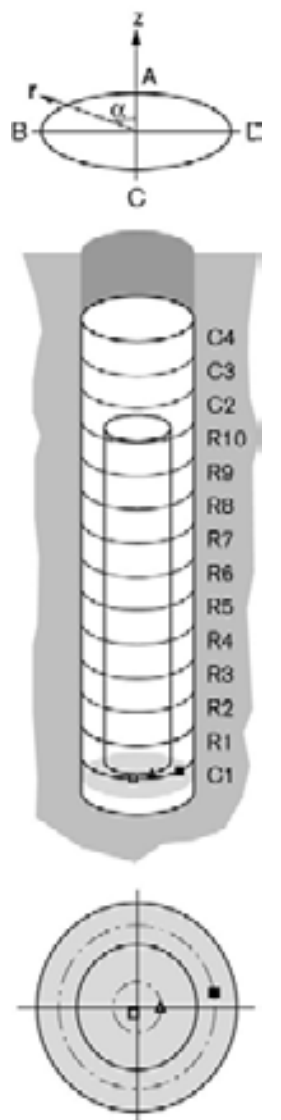




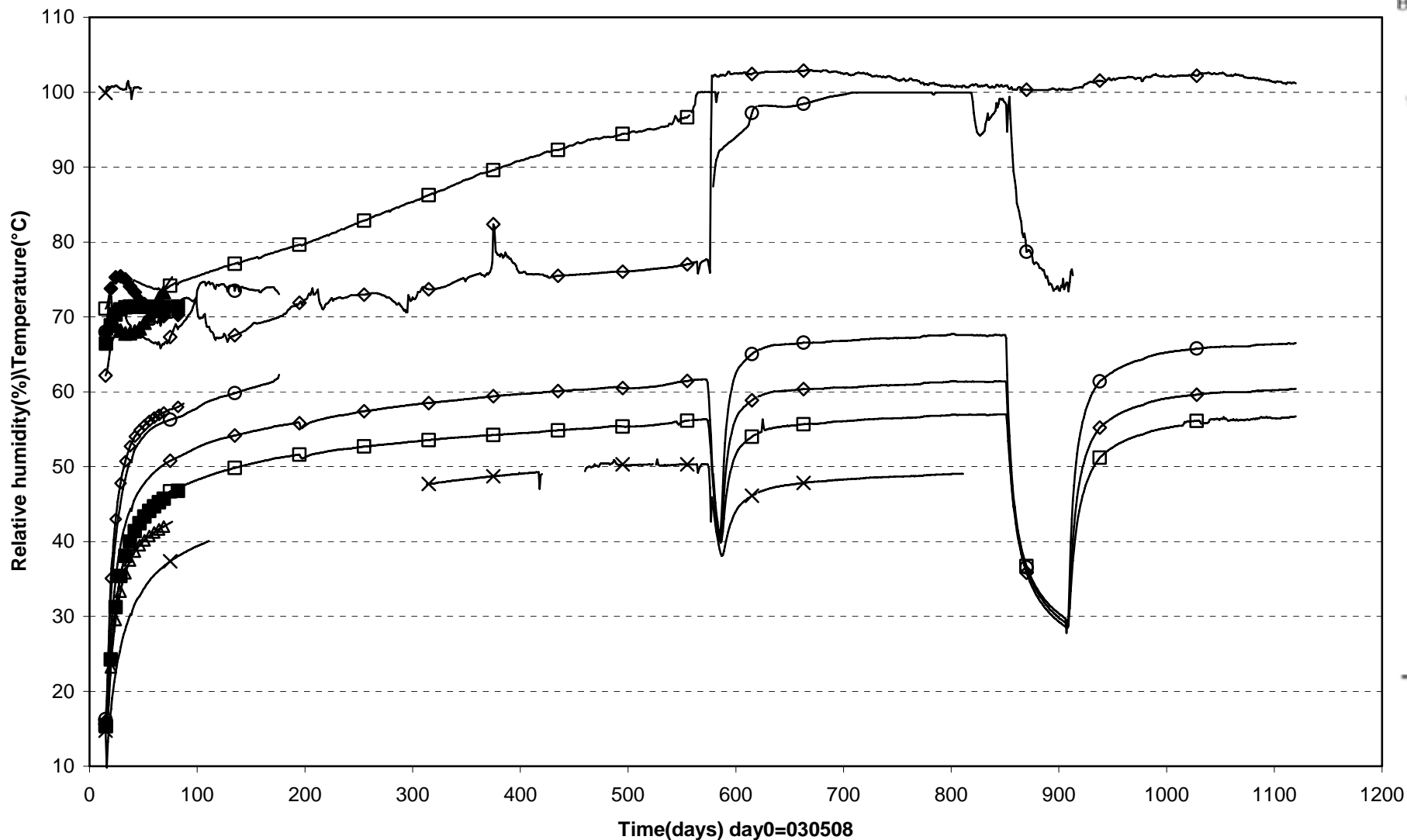
Prototype\Hole 6\Cyl.1 (030508-060601)  
Relative humidity



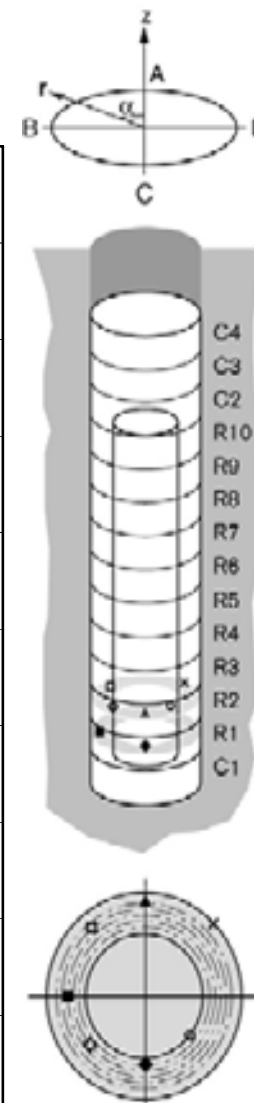
■ WB667(0.260\280°\0.685) □ WB601 (0.260\135°\0.050) △ WB604 (0.260\270°\0.210)



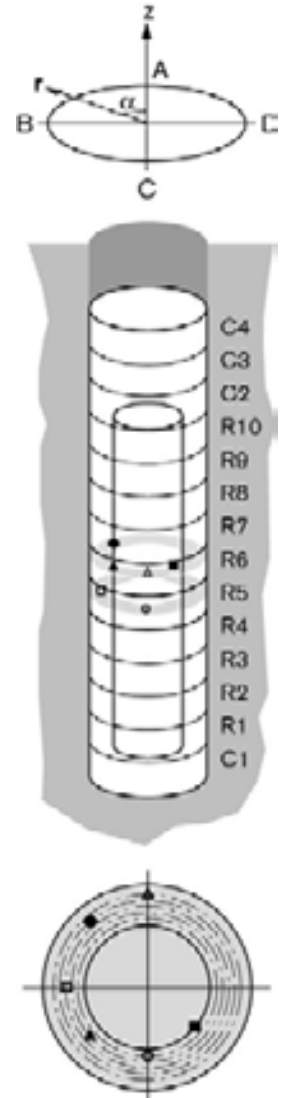
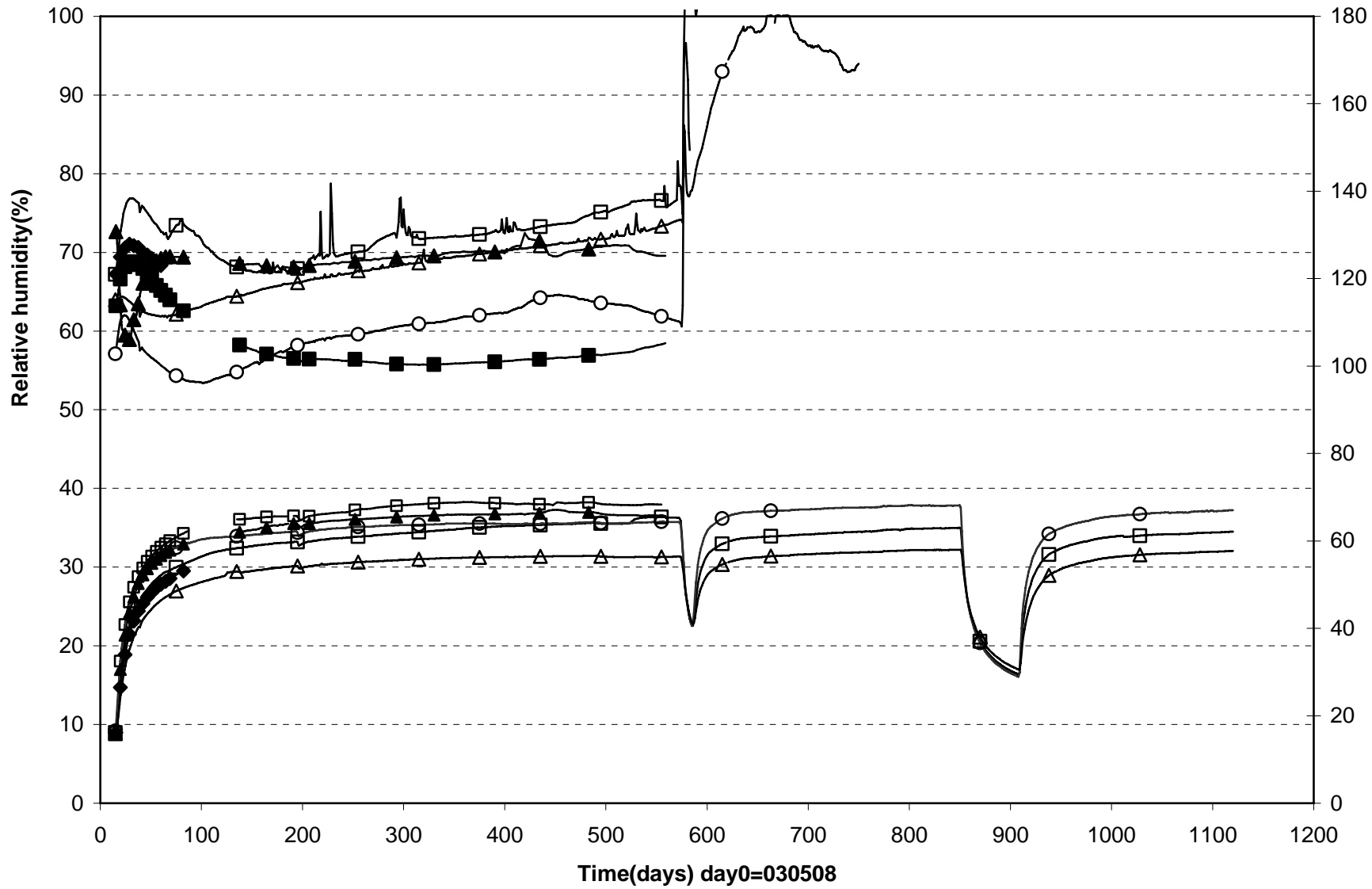
Prototype\Hole 6\ Ring 1 and Ring 2 (030508-060601)  
Relative humidity



■ WB607(0.770\90°\0.685)	◆ WB609(0.770\180°\0.585)	▲ WB612(0.770\360°\0.785)	□ WB613(1.284\40°\0.735)
◇ WB615(1.284\130°\0.635)	○ WB617(1.284\230°\0.535)	× WB620(1.253\315°\0.875)	

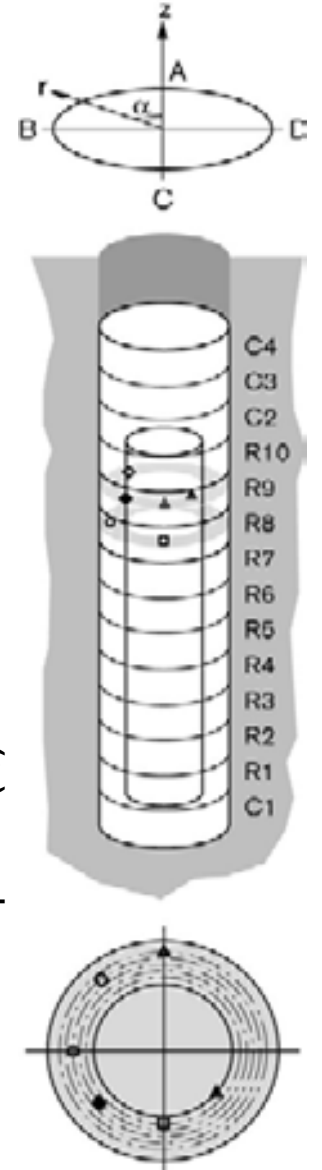
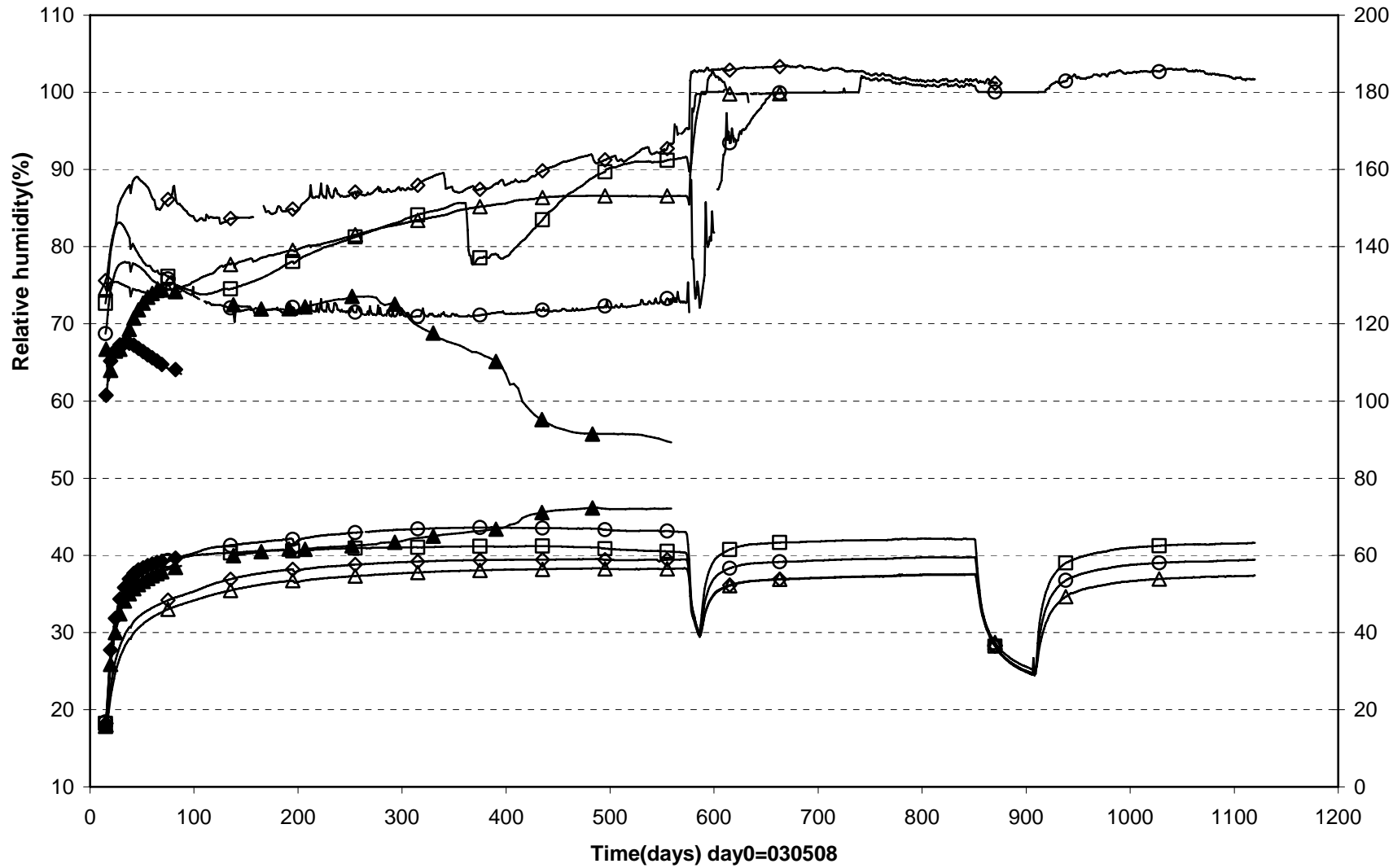


Prototype\Hole 6\Ring 5 and Ring 6 (030508-060601)  
Relative humidity



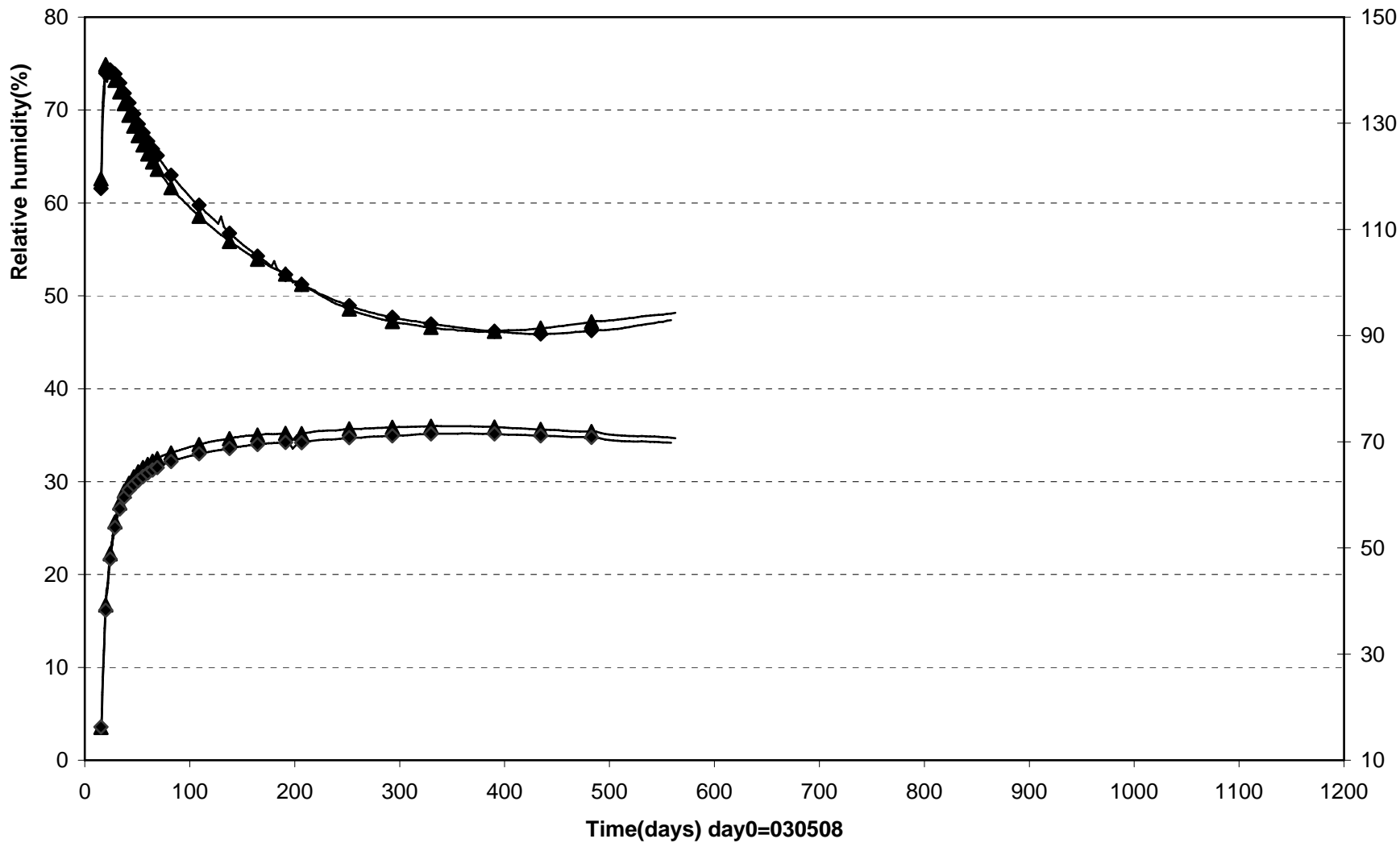
▲ WB629(3.300\130°\0.635)	■ WB631(3.300\230°\0.535)	◆ WB627(3.300\40°\0.735)	□ WB621(2.795\90°\0.685)
○ WB623(2.795\180°\0.585)	△ WB626(2.795\360°\0.785)		

Prototype\Hole 6\ Ring 8 and Ring9 (030508-060601)  
Relative humidity

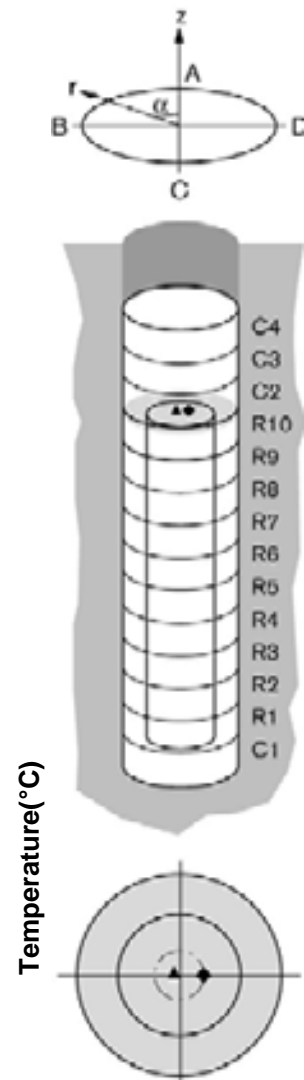


- |                           |                           |                          |                           |
|---------------------------|---------------------------|--------------------------|---------------------------|
| ◆ WB643(4.834\130°\0.635) | ▲ WB645(4.834\230°\0.535) | ○ WB635(4.324\90°\0.685) | □ WB637(4.324\180°\0.585) |
| △ WB640(4.324\360°\0.785) | ◇ WB641(4.834\40°\0.735)  |                          |                           |

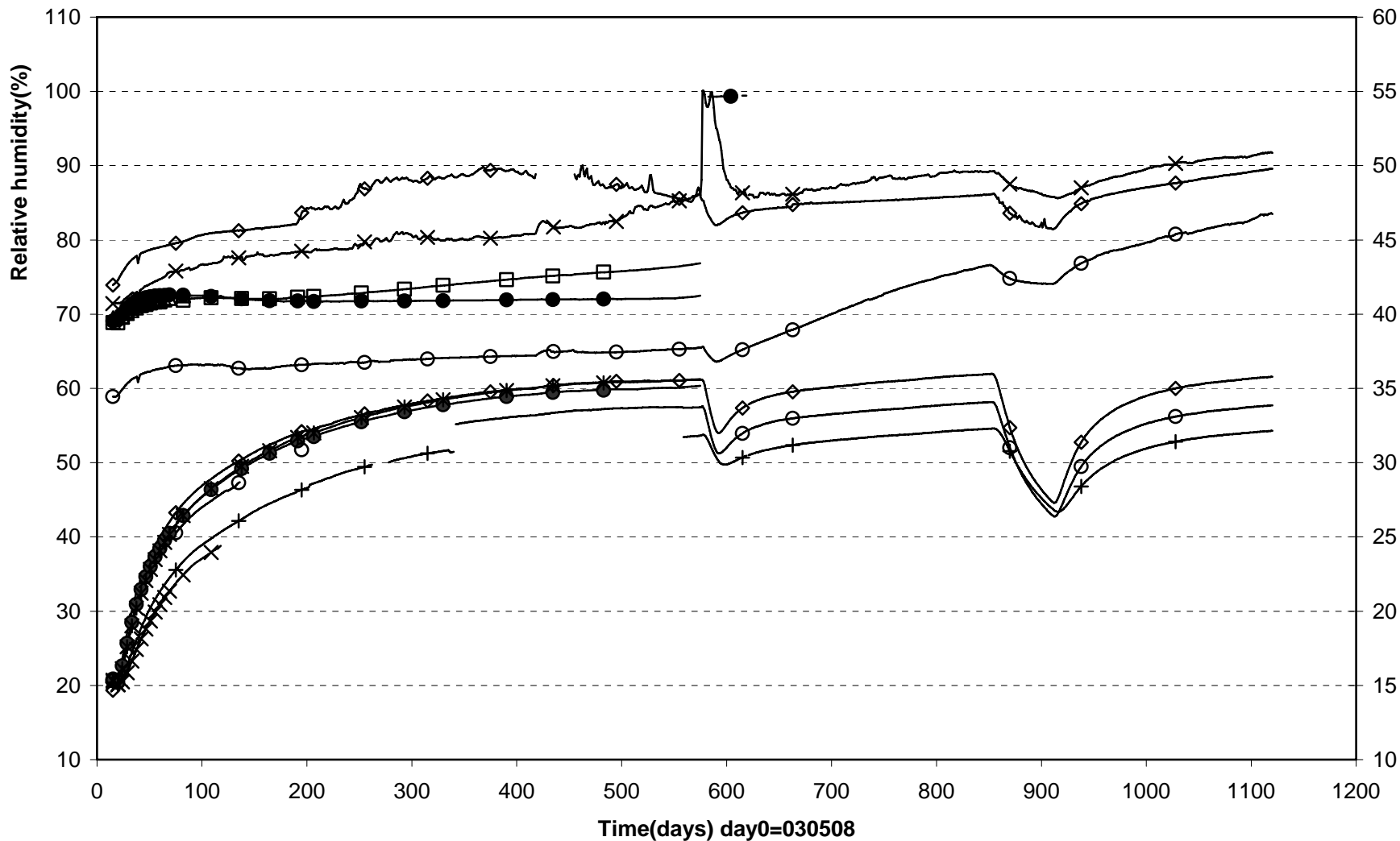
Prototype\Hole 6\ Ring10 (030508-060601)  
Relative humidity



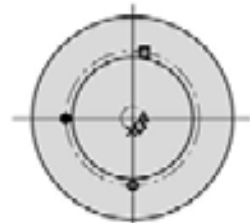
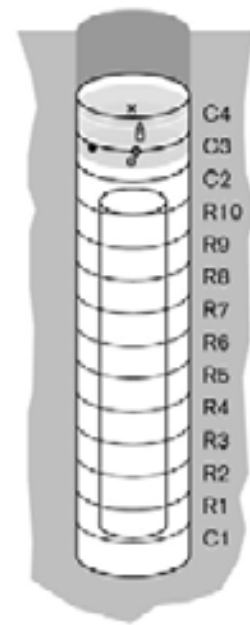
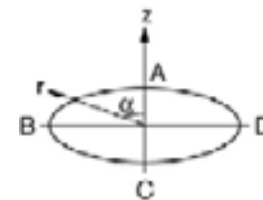
▲ WB649(5.439\90°\0.50) ◆ WB650(5.439\270°\0.210)



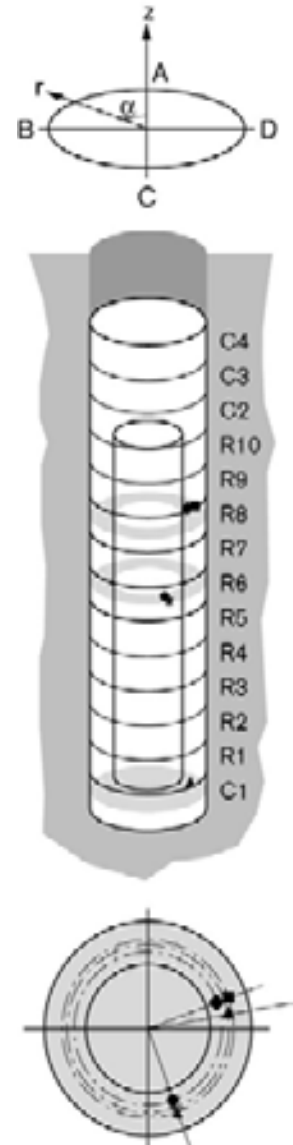
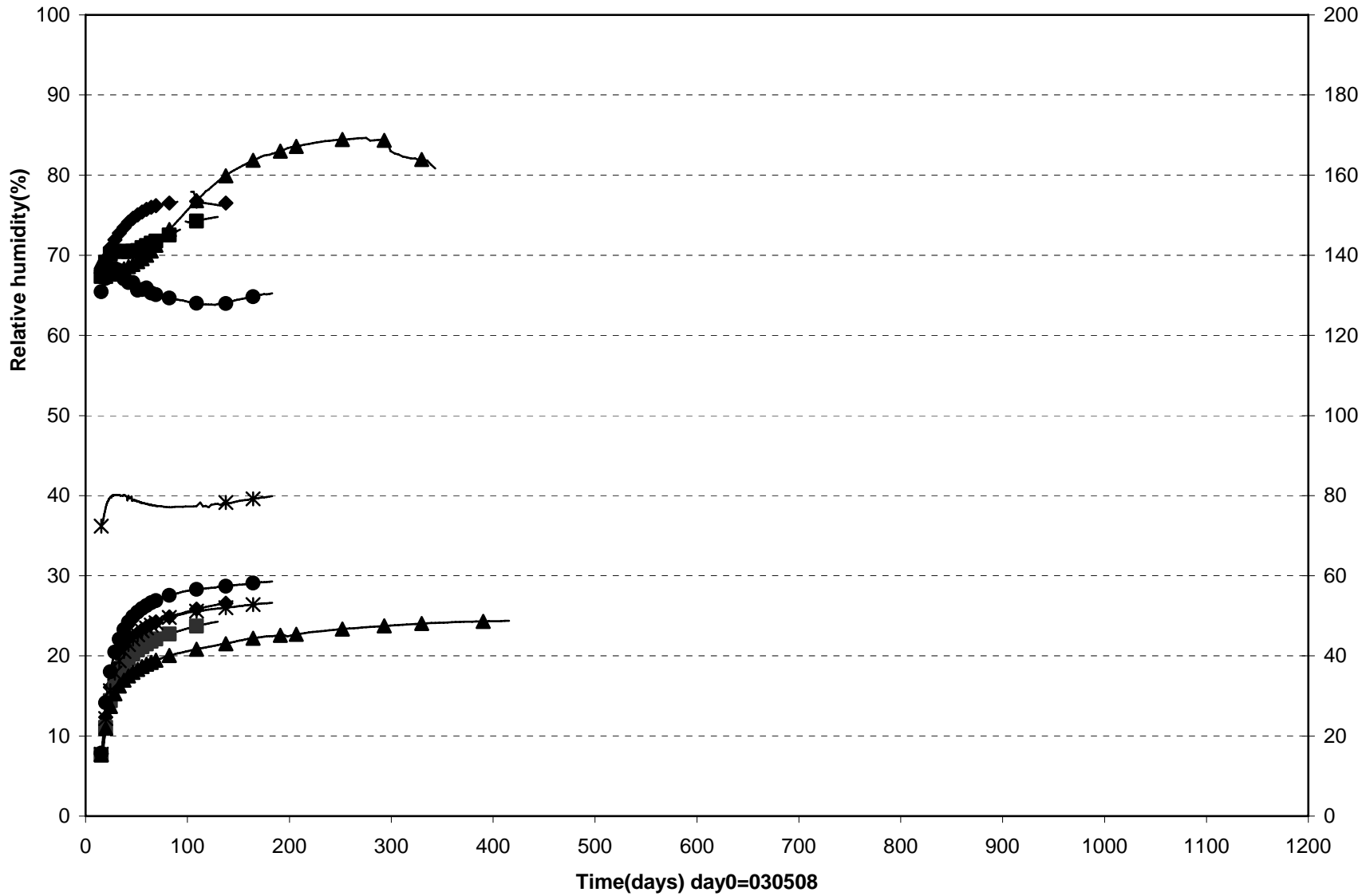
Prototype\Hole 6\Cyl.3 and Cyl.4 (030508-060601)  
Relative humidity



● WB652(6.366\90°\0.585)    □ WB654(6.366\350°\0.585)    △ WB656(6.961\270°\0.100)    ◇ WB651(6.366\225°\0.100)  
○ WB653(6.366\180°\0.585)    × WB655(6.801\180°\0.100)

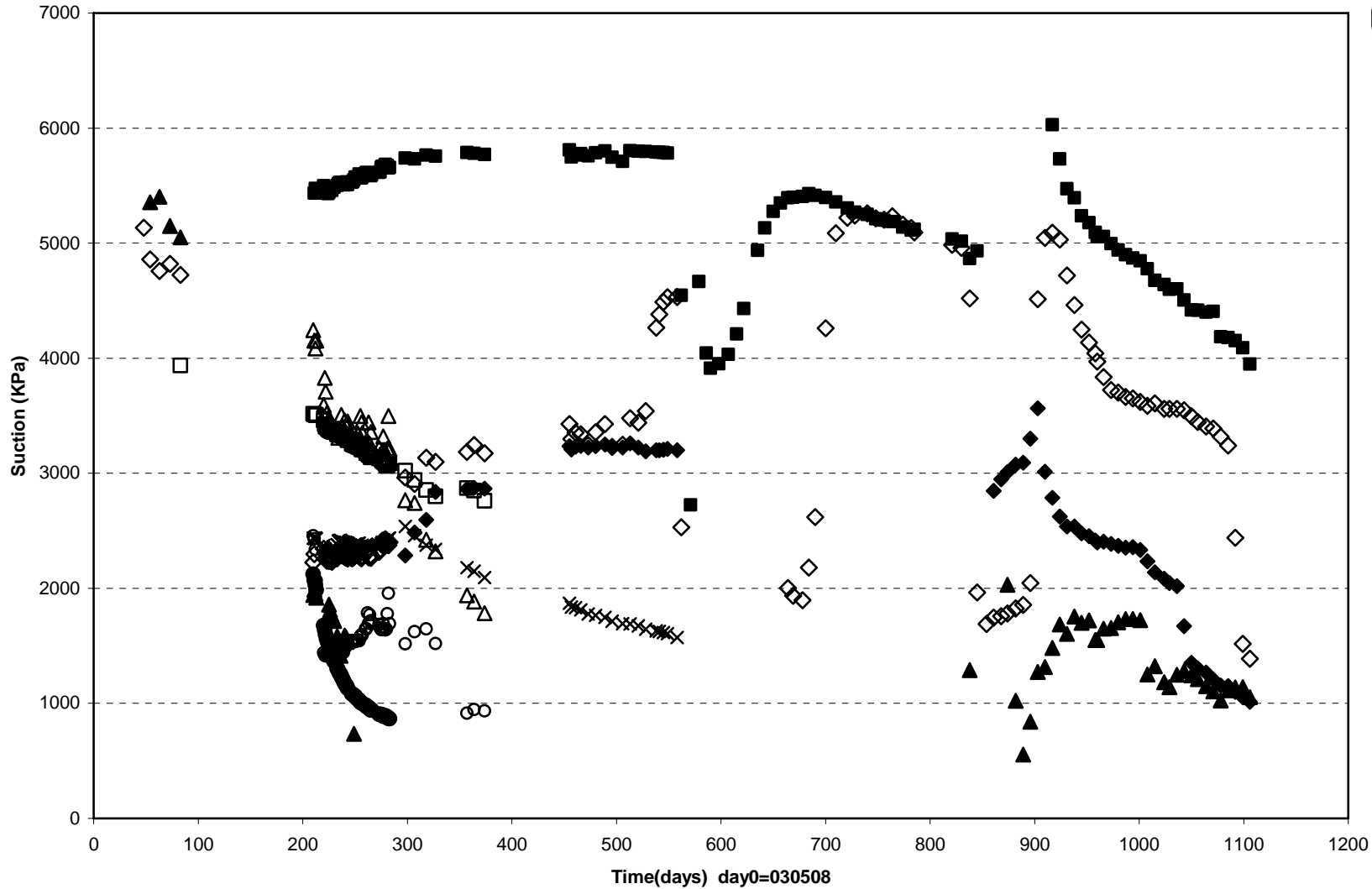


Prototype\Hole 6\Cyl.1 , Ring 6 and Ring8 (030508-060601)  
 Relative humidity

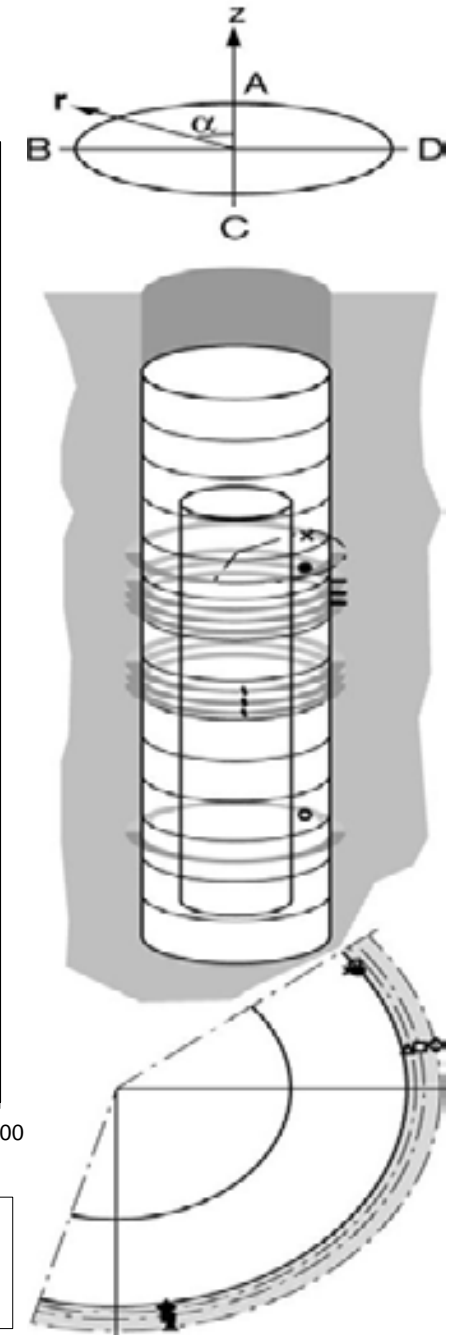


▲ WB667(0.260\280°\0.685) ● WB668(3.300\200°\0.625) ✖ WB669(3.300\200°\0.725) ◆ WB670(4.324\290°\0.625) ■ WB671(4.324\290°\0.725)

Prototype\ Hole 6 \Rock (030508-060601)  
Suction - Wescor

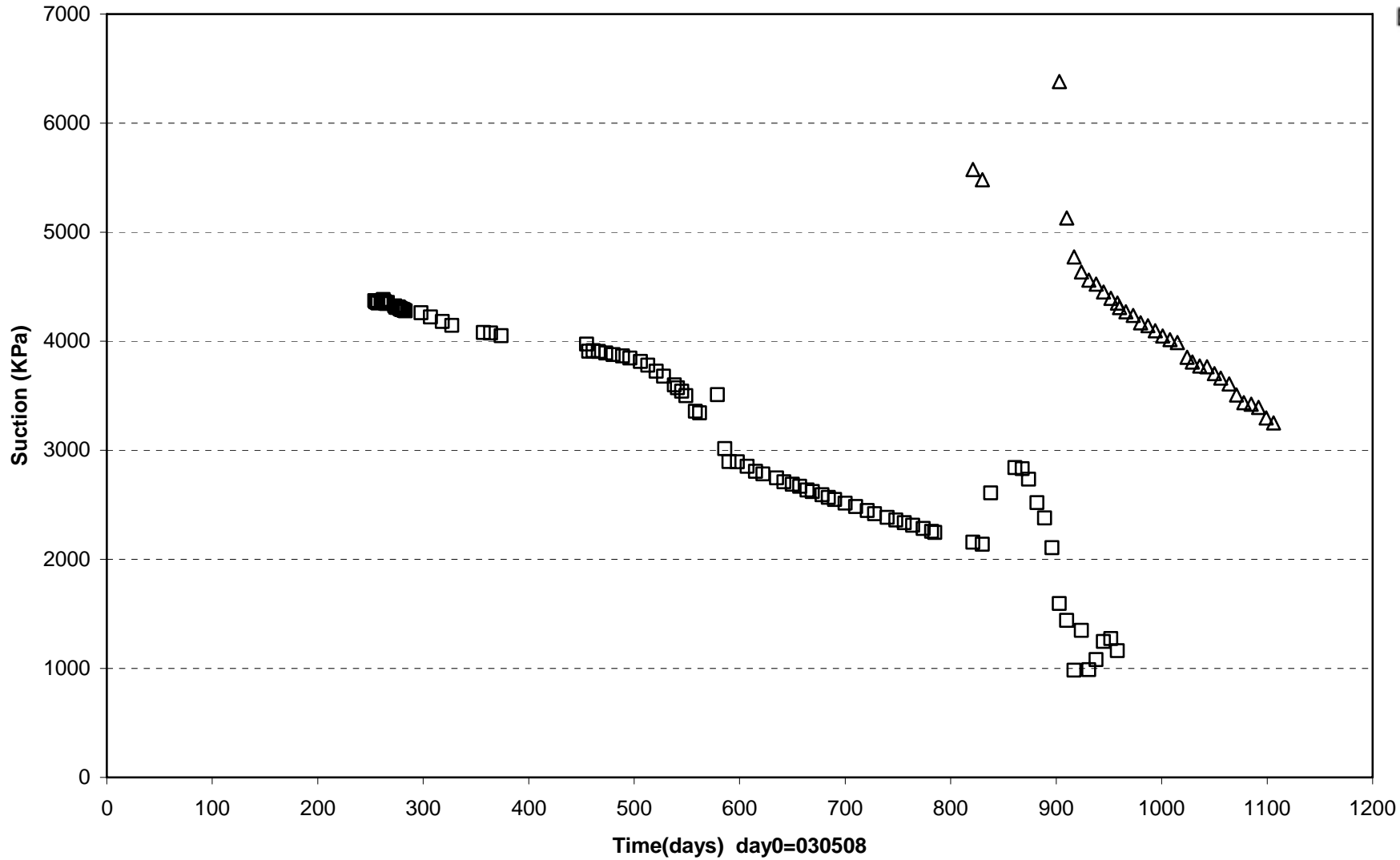


◆ WB659(3.100\190°\0.900\Rock)	■ WB660(3.250\190°\0.925\Rock)	▲ WB661(3.400\190°\0.975\Rock)
△ WB664(4.100\280°\0.900\Rock)	□ WB665(4.250\280°\0.925\Rock)	◇ WB666(4.400\280°\0.975\Rock)
○ WB619(1.253\305°\0.875\Rock)	● WB633(3.253\305°\0.875\Rock)	× WB647(4.753\305°\0.875\Rock)

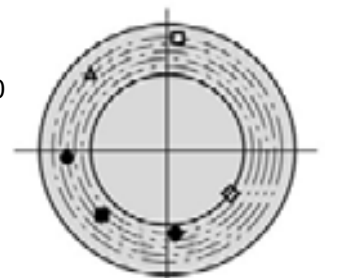
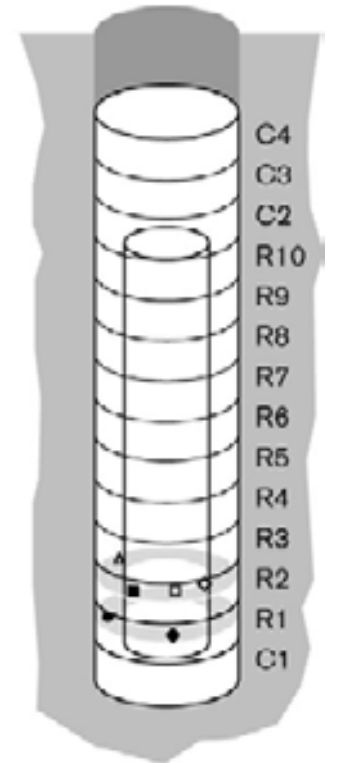
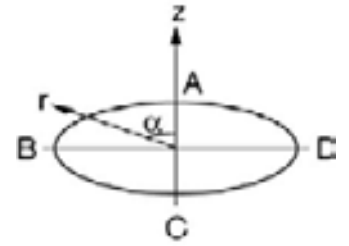




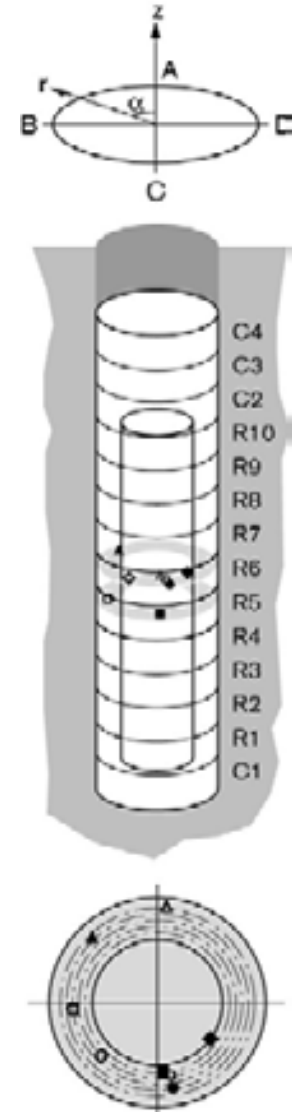
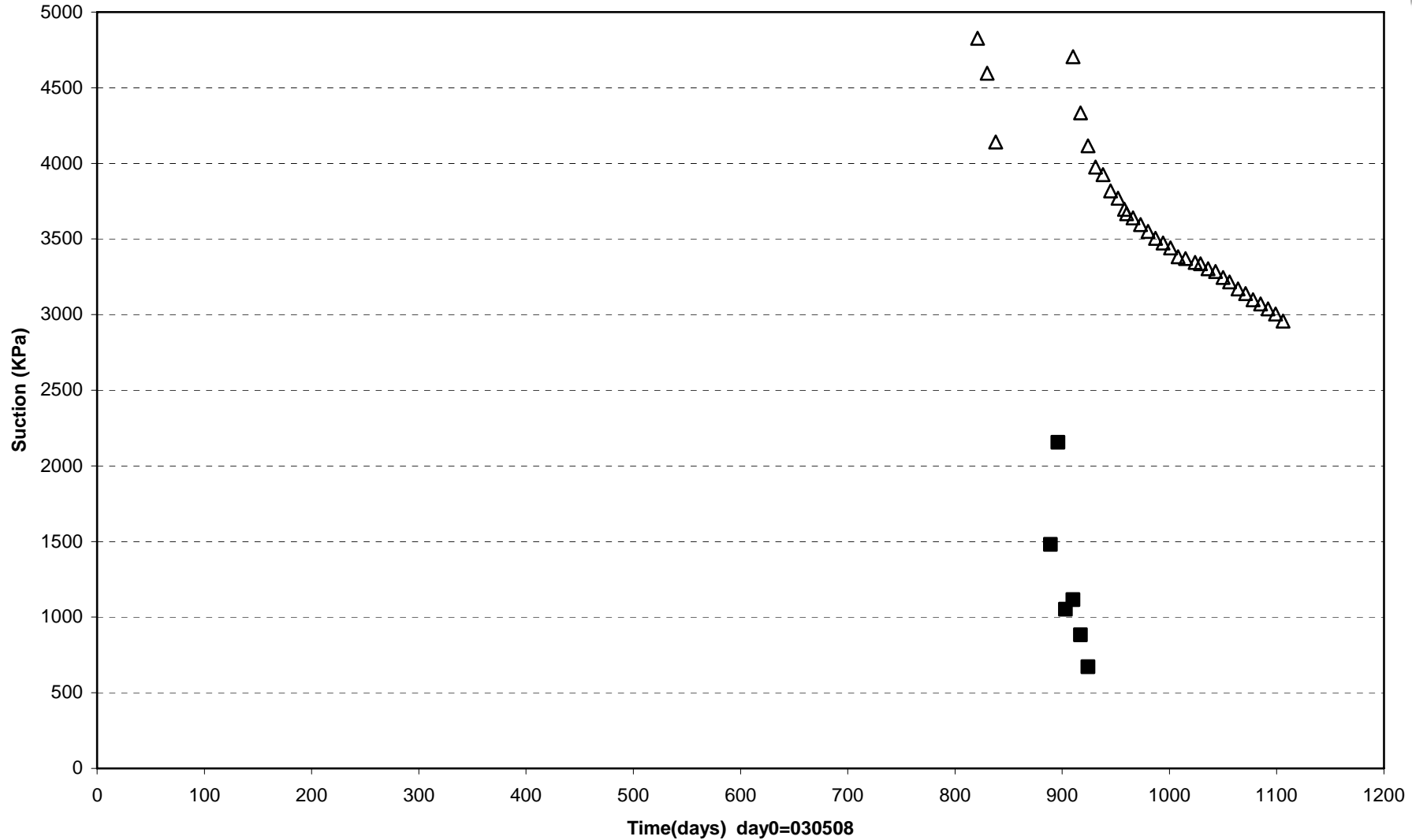
Prototype\ Hole 6 \ Ring 1 and Ring 2 (030508-060601)  
Suction - Wescor



- WB608(0.770\95°\0.685)    ◆ WB612(0.750\185°\0.585)    □ WB611(0.770\355°\0.785)
- △ WB614(1.284\45°\0.735)    ■ WB616(1.284\135°\0.635)    ◇ WB618(1.284\235°\0.535)

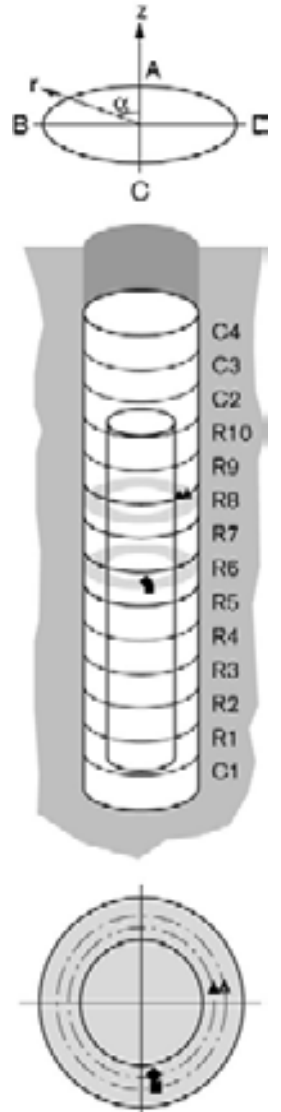
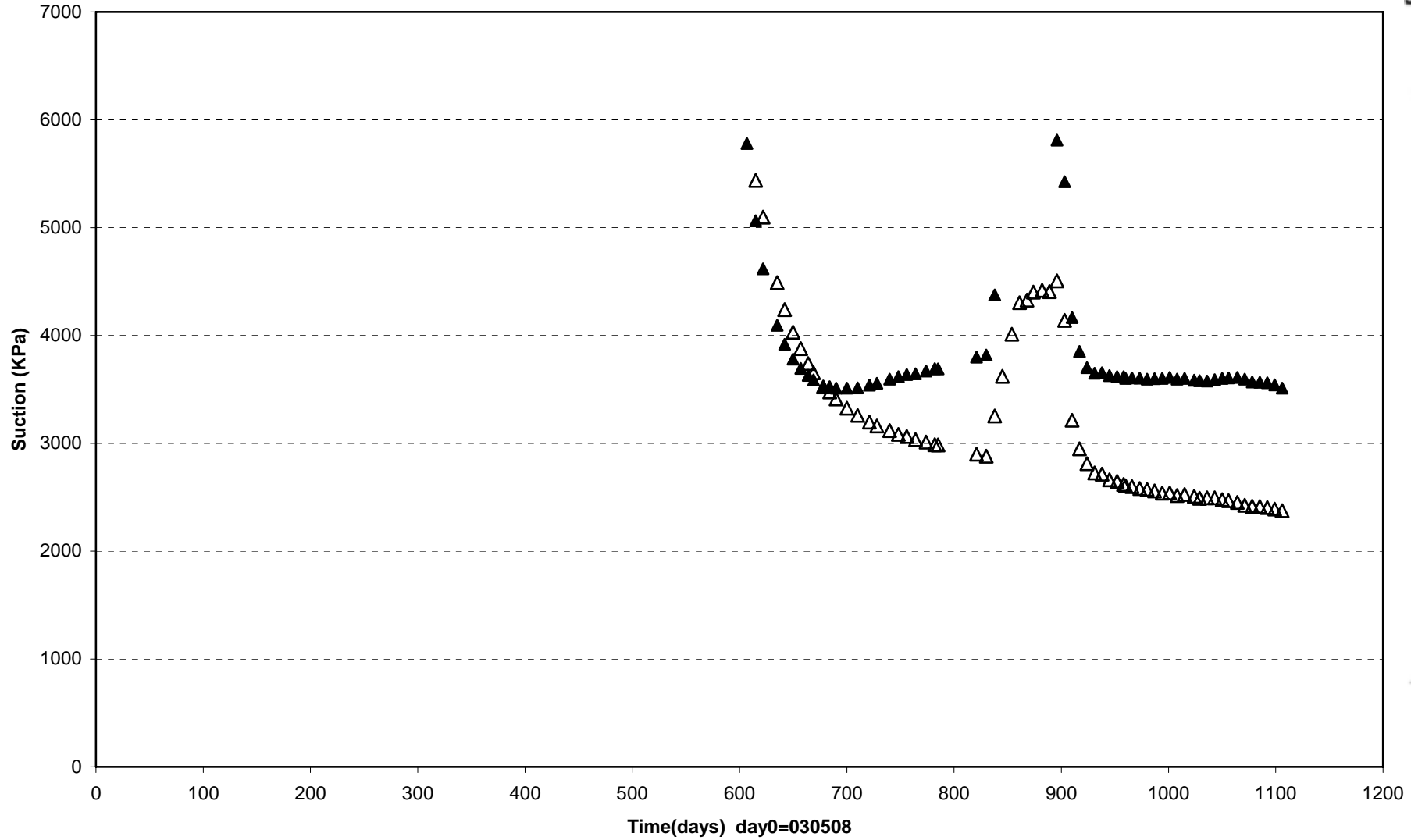


Prototype\ Hole 6 \ Ring 5 and Ring 6 (030508-060601)  
Suction - Wescor



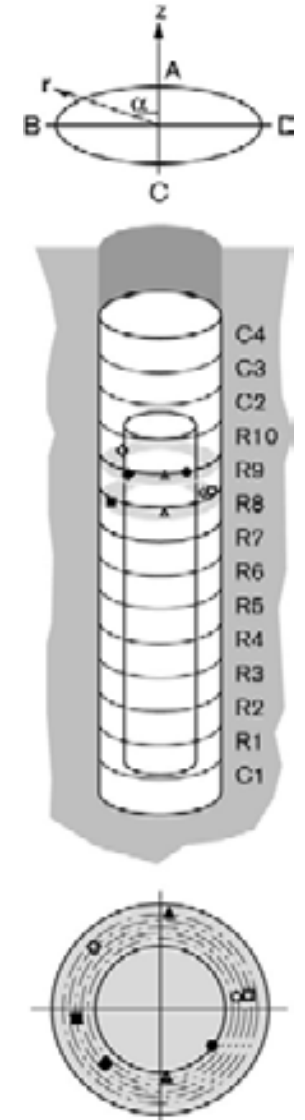
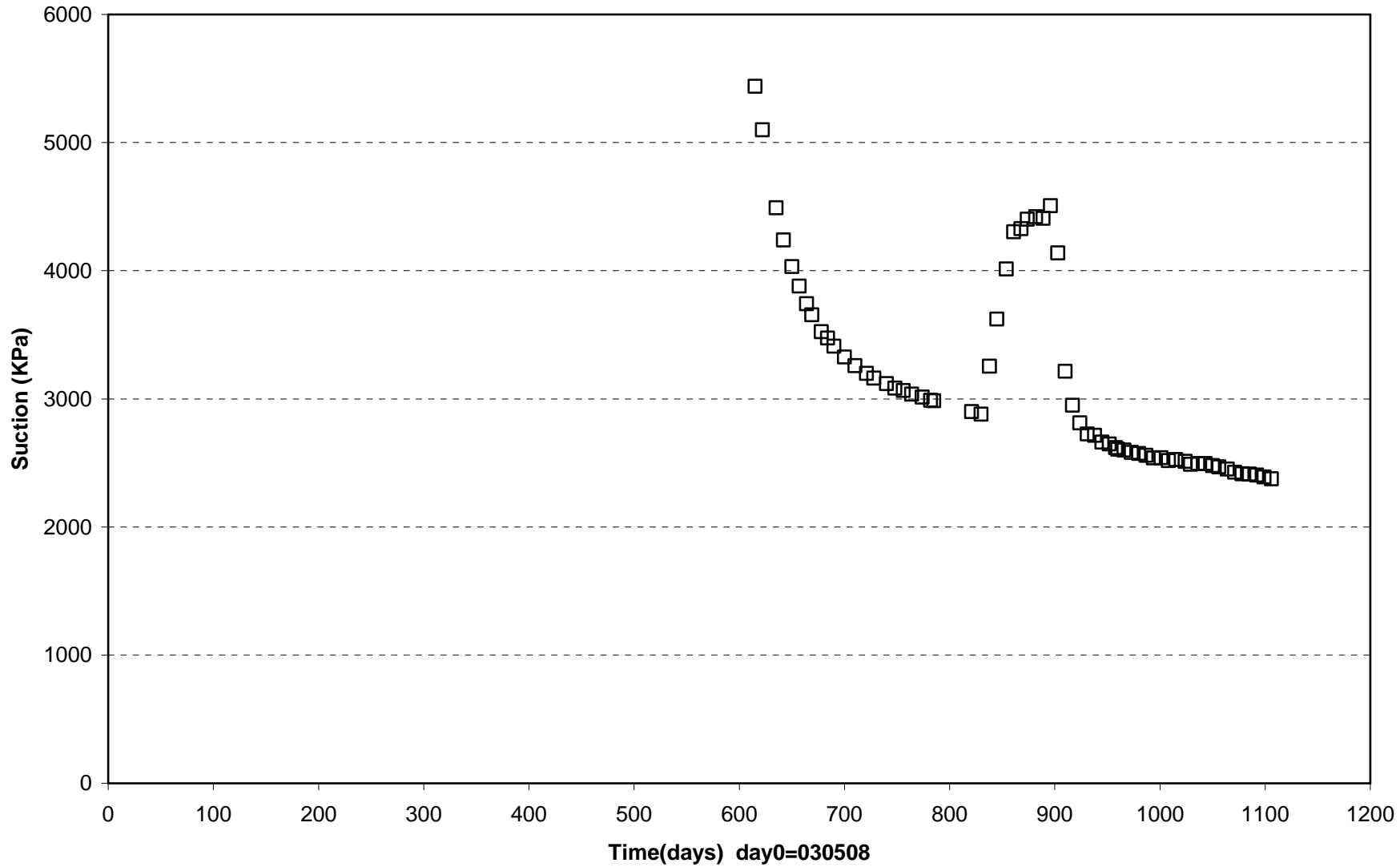
□ WB622(2.795\95°\0.685)    ■ WB624(2.795\185°\0.585)    △ WB625(2.795\355°\0.785)    ▲ WB628(3.300\45°\0.735)  
 ◇ WB630(3.300\135°\0.635)    ◆ WB632(3.300\235°\0.535)    ○ WB657(3.300\190°\0.625)    ● WB658(3.300\190°\0.725)

Prototype\ Hole 6 \ Ring 6 and Ring 8 (030508-060601)  
Suction - Wescor



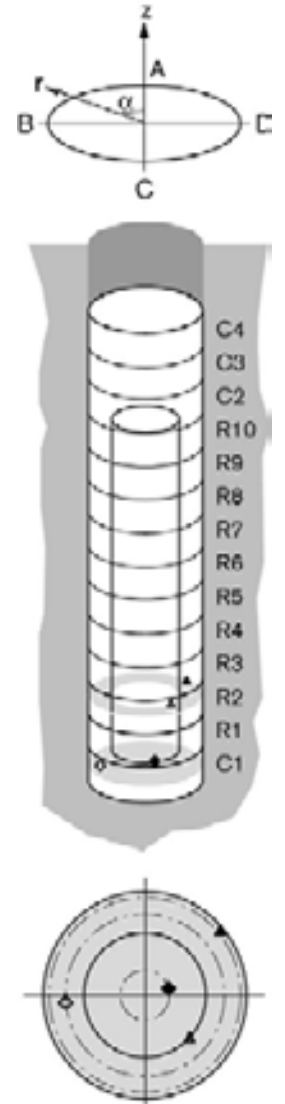
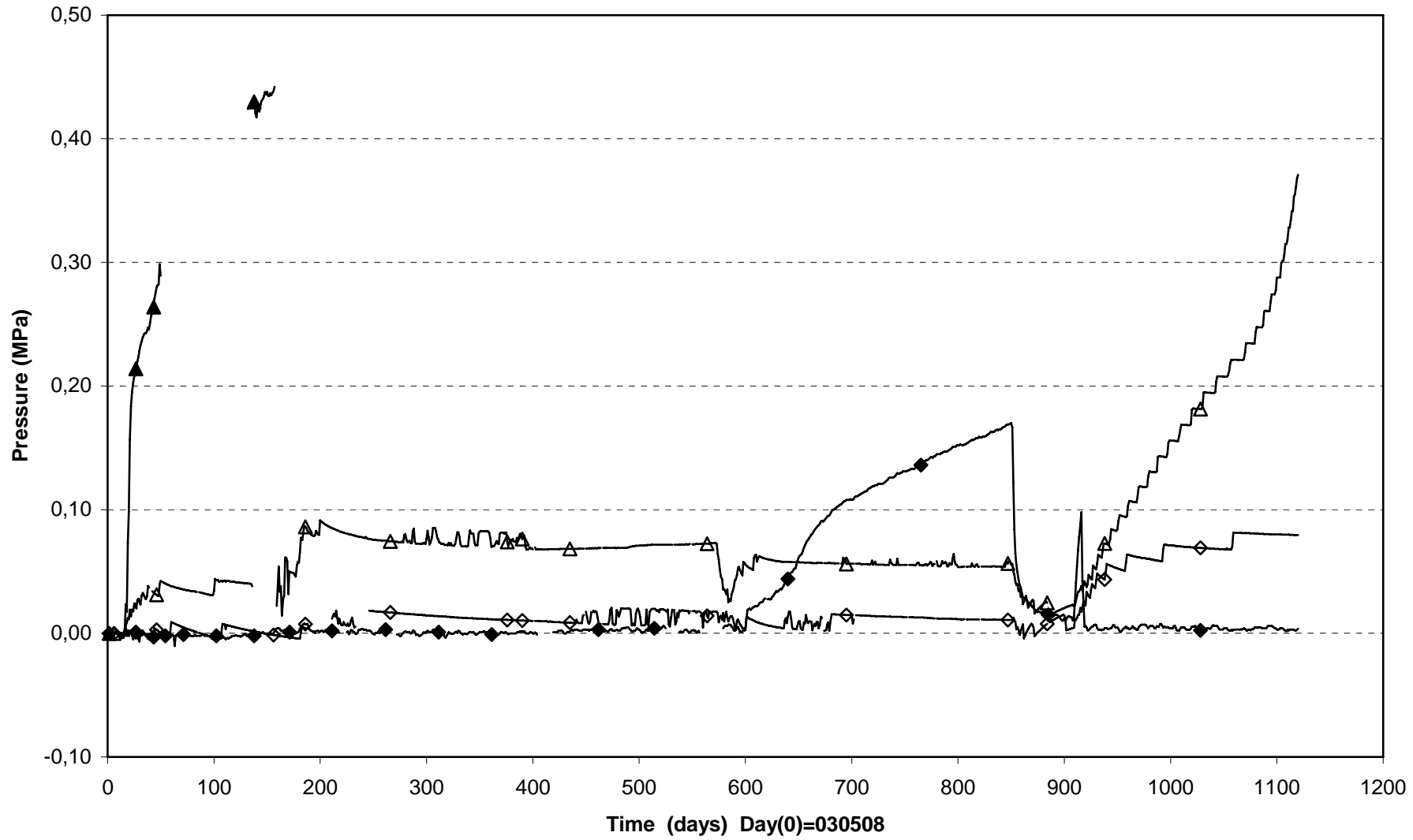
◆ WB657(3.300\190°\0.625) ■ WB658(3.300\190°\0.725) ▲ WB662(4.324\280°\0.625) △ WB663(4.324\280°\0.725)

Prototype\ Hole 6 \ Ring 8 and Ring 9 (030508-060601)  
Suction - Wescor



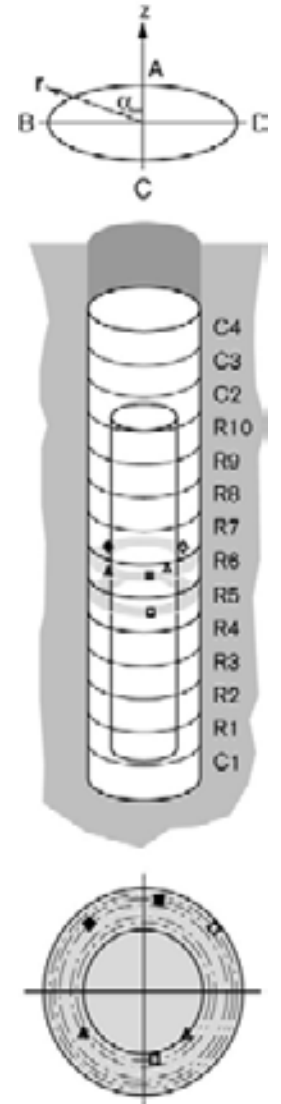
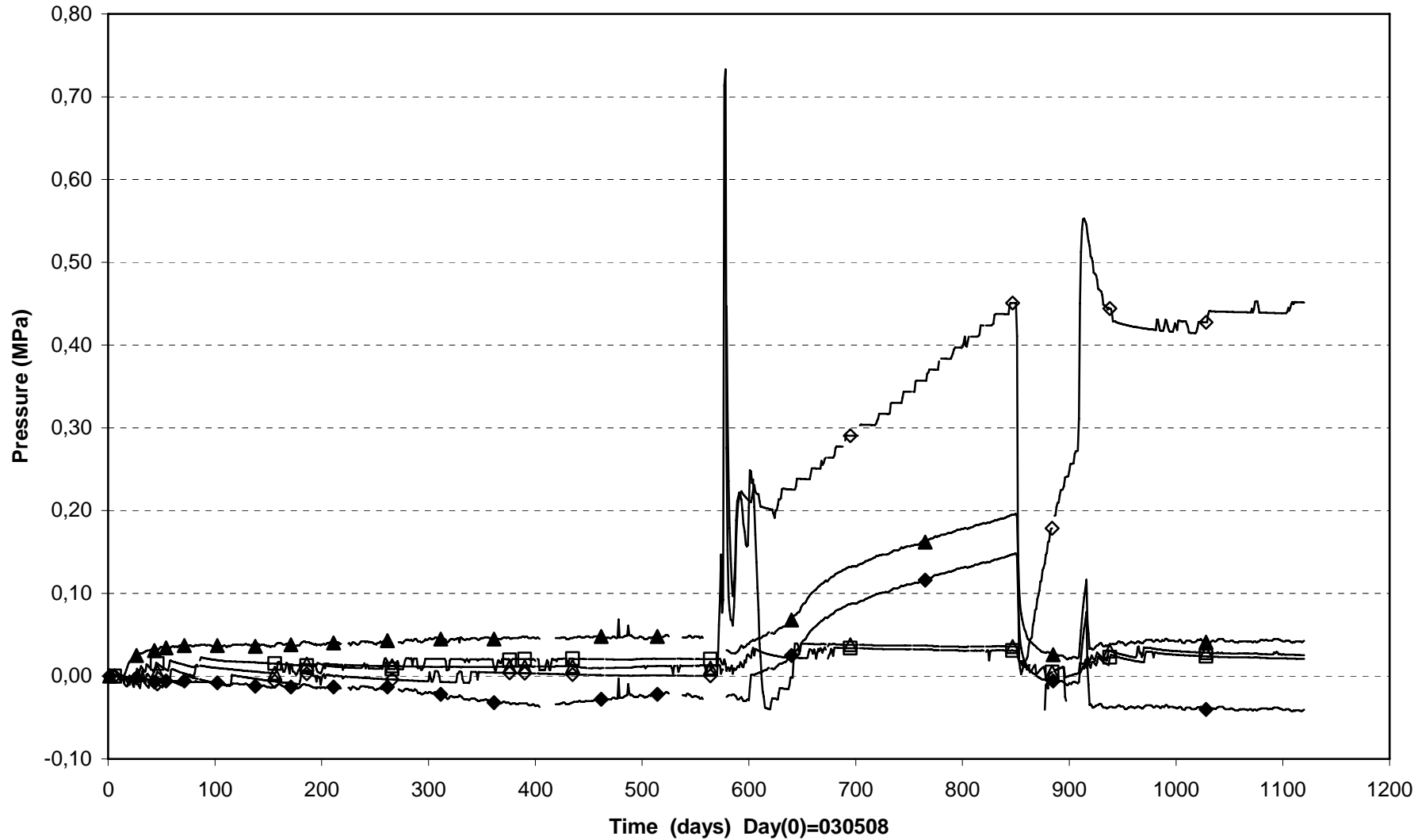
- WB636(4.324\95°\0.685)    △ WB638(4.324\185°\0.585)    ▲ WB639(4.324\355°\0.785)    ◇ WB642(4.834\45°\0.735)
- ◆ WB644(4.834\135°\0.635)    ● WB646(4.834\235°\0.535)    ○ WB662(4.324\280°\0.625)    □ WB663(4.324\280°\0.725)

Prototype\Hole6 \Cyl.1 and Ring2 (030508-060601)  
Pore pressure



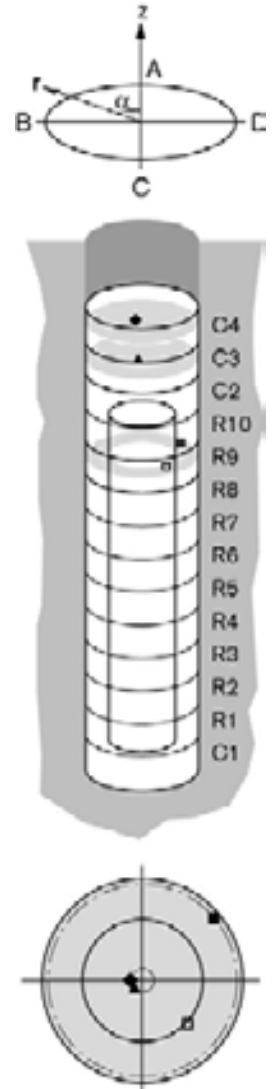
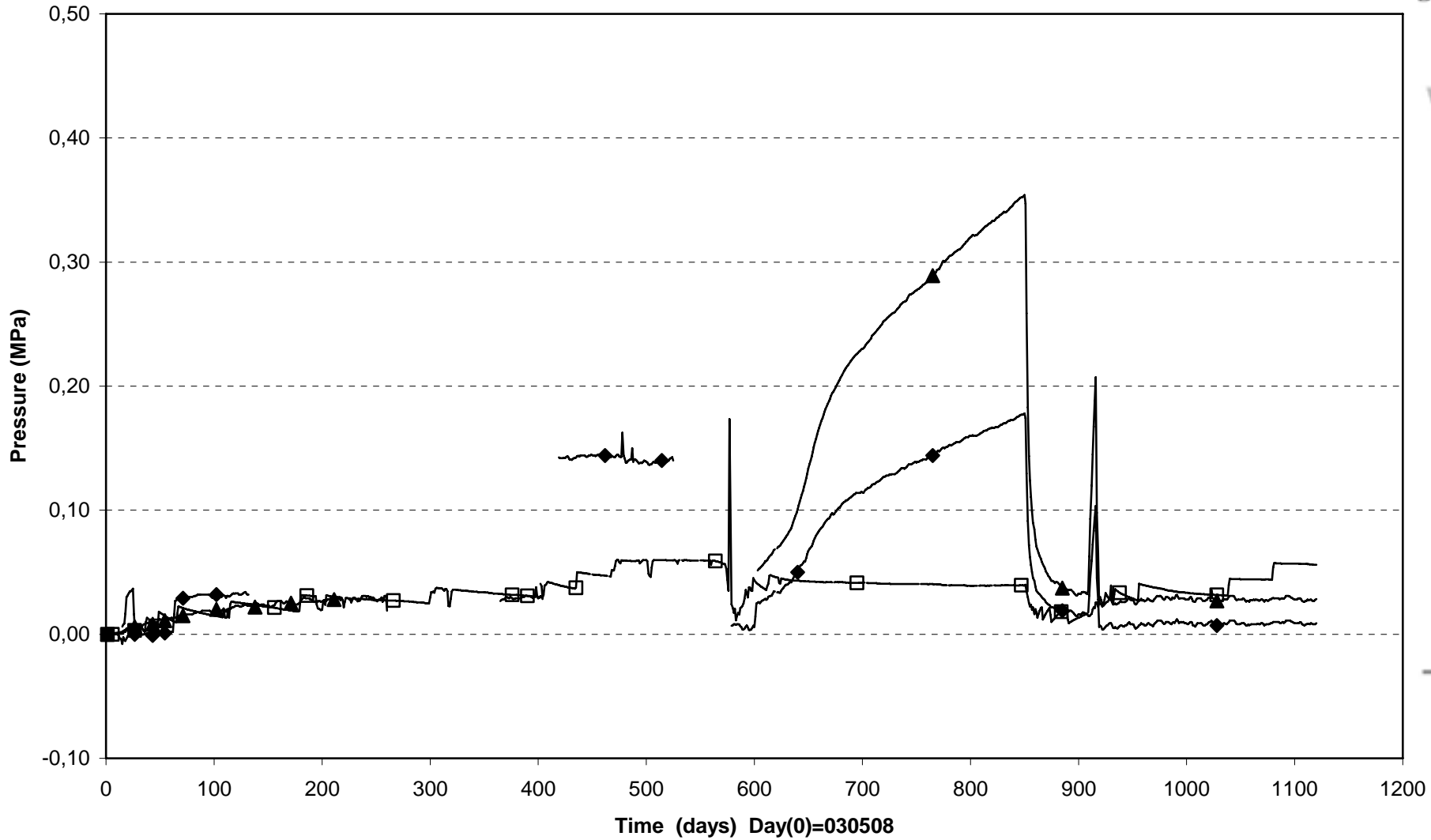
◆ UB601(0.260 \280^\ 0.210) ◇ UB602(0.260\95^\ 0.685)      △ UB603(1.284\225^\ 0.535)      ▲ UB604(1.253 \310^\ 0.875)

Prototype\Hole6 \ Ring 5 and Ring 6 (030508-060601)  
Pore pressure



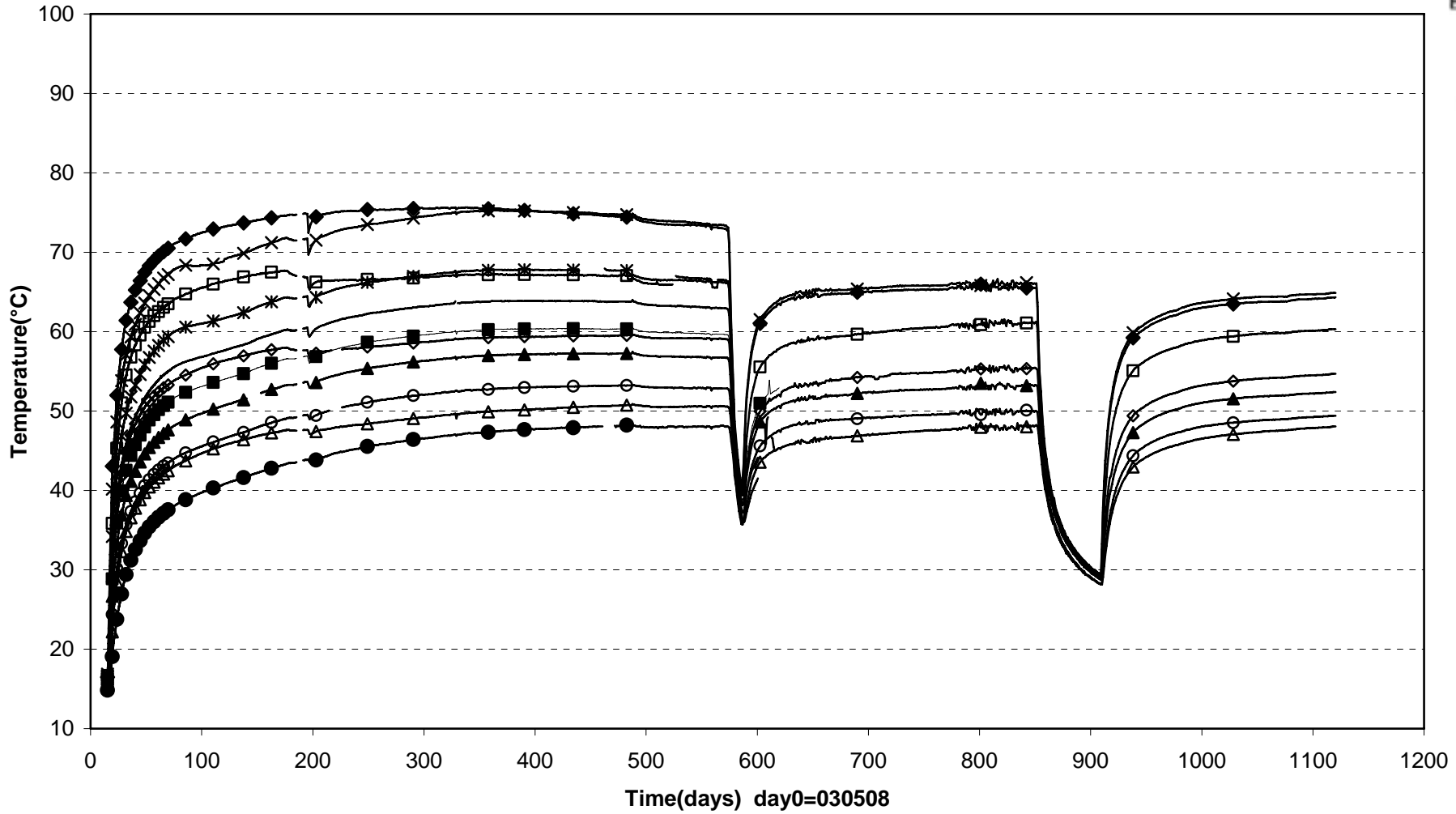
□ UB605(2.795\190°\0.585)	■ UB606(2.795 \350°\ 0.785)	◆ UB607(3.300 \35°\ 0.735)
▲ UB608(3.300 \125°\ 0.635)	△ UB609(3.300\225°\0.535)	◇ UB610(3.253\310°\0.875)

Prototype\Hole6\Ring 9 , Cyl.3 and Cyl.4 (030508-060601)  
 Pore pressure



□ UB611(4.834\225°\0.535)
■ UB612(4.753 \310°\ 0.875)
▲ UB613(6.366 \135°\ 0.100)
◆ UB614(6.961 \90°\ 0.100)

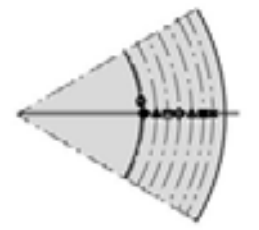
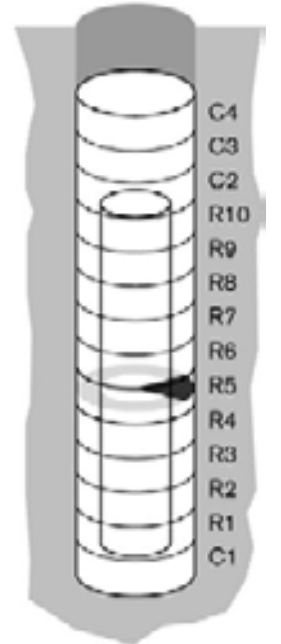
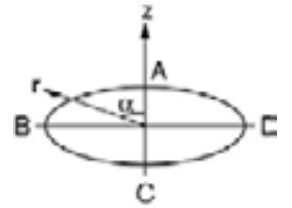
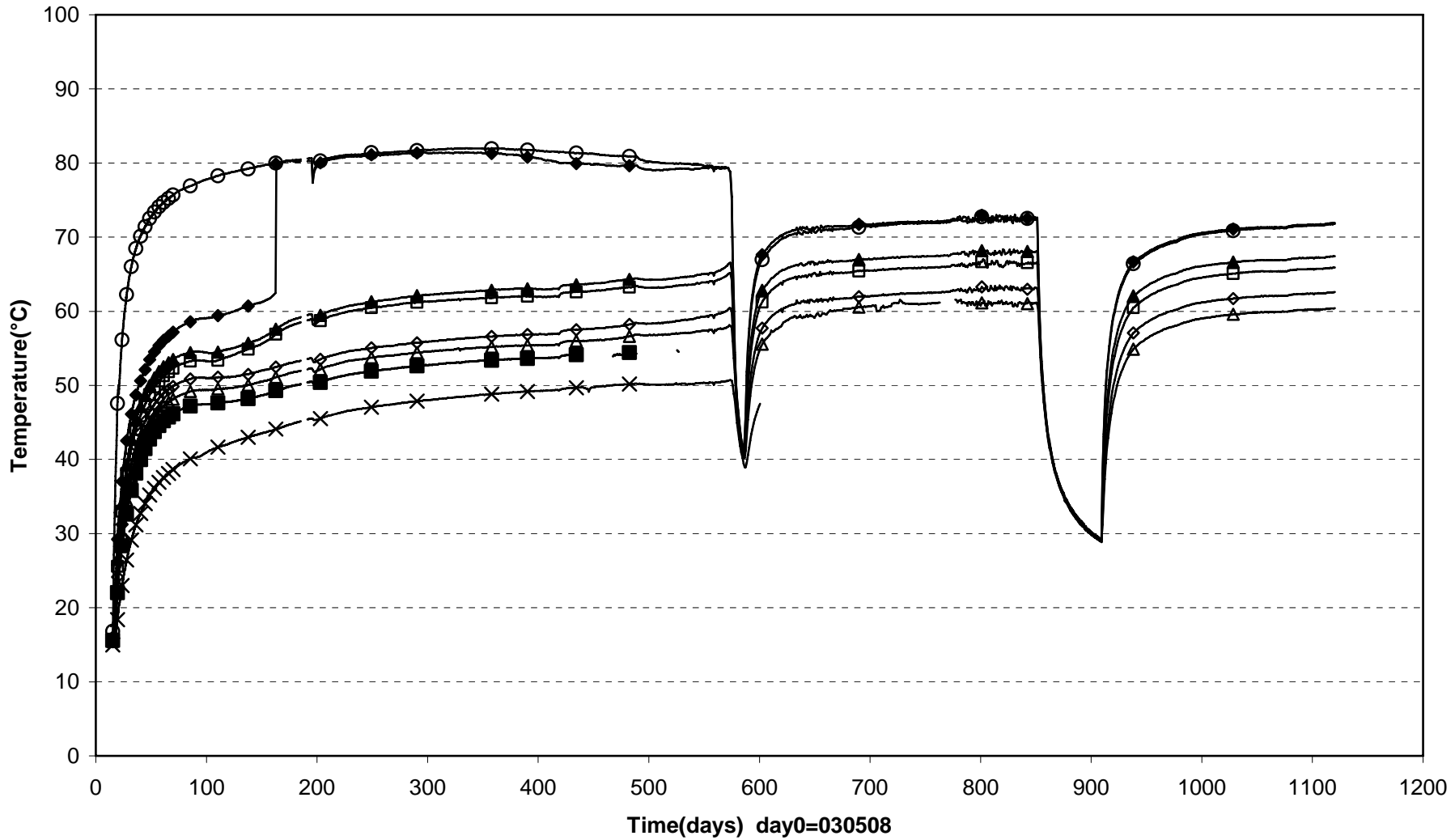
Prototype\Hole 6\Cyl.1 and Ring1 (030508-060601)  
 Temperature - Pentronic



□ TB601(0.385\45°\0.050)	◇ TB602(0.260\315°\0.050)	△ TB603(0.135\0°\0.050)	× TB604(0.770\270°\0.535)
× TB605(0.770\270°\0.585)	■ TB607(0.770\270°\0.685)	▲ TB608(0.770\270°\0.735)	○ TB609(0.770\270°\0.785)
● TB610(0.753\270°\0.875)	◆ TB611(0.753\ 0°\0.525)	— TB606(0.750\270°\0.635)	

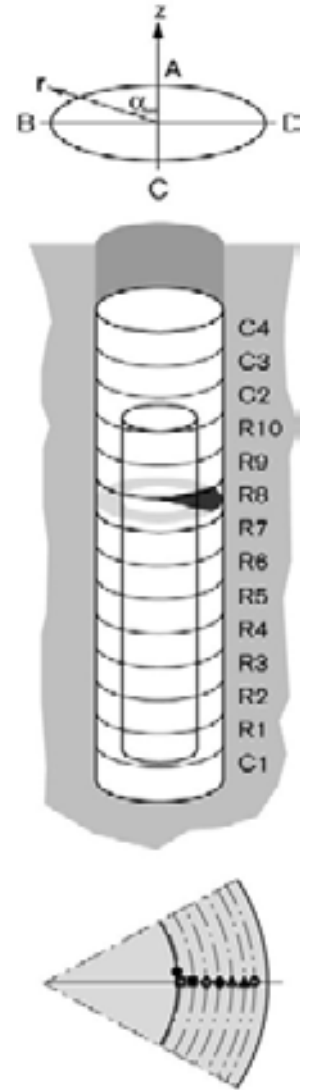
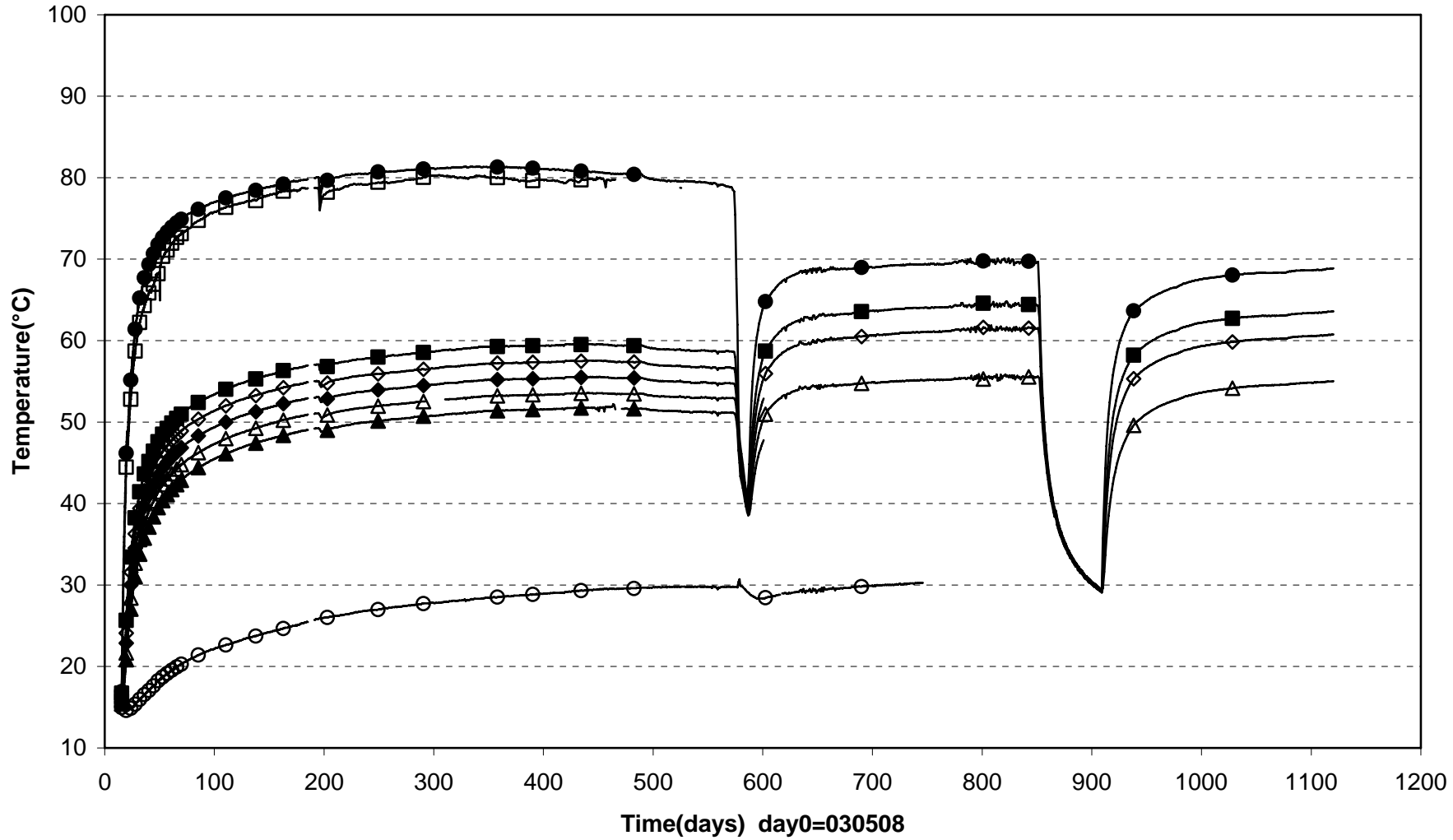


Prototype\Hole 6 \Ring5 (030508-060601)  
 Temperature - Pentronic



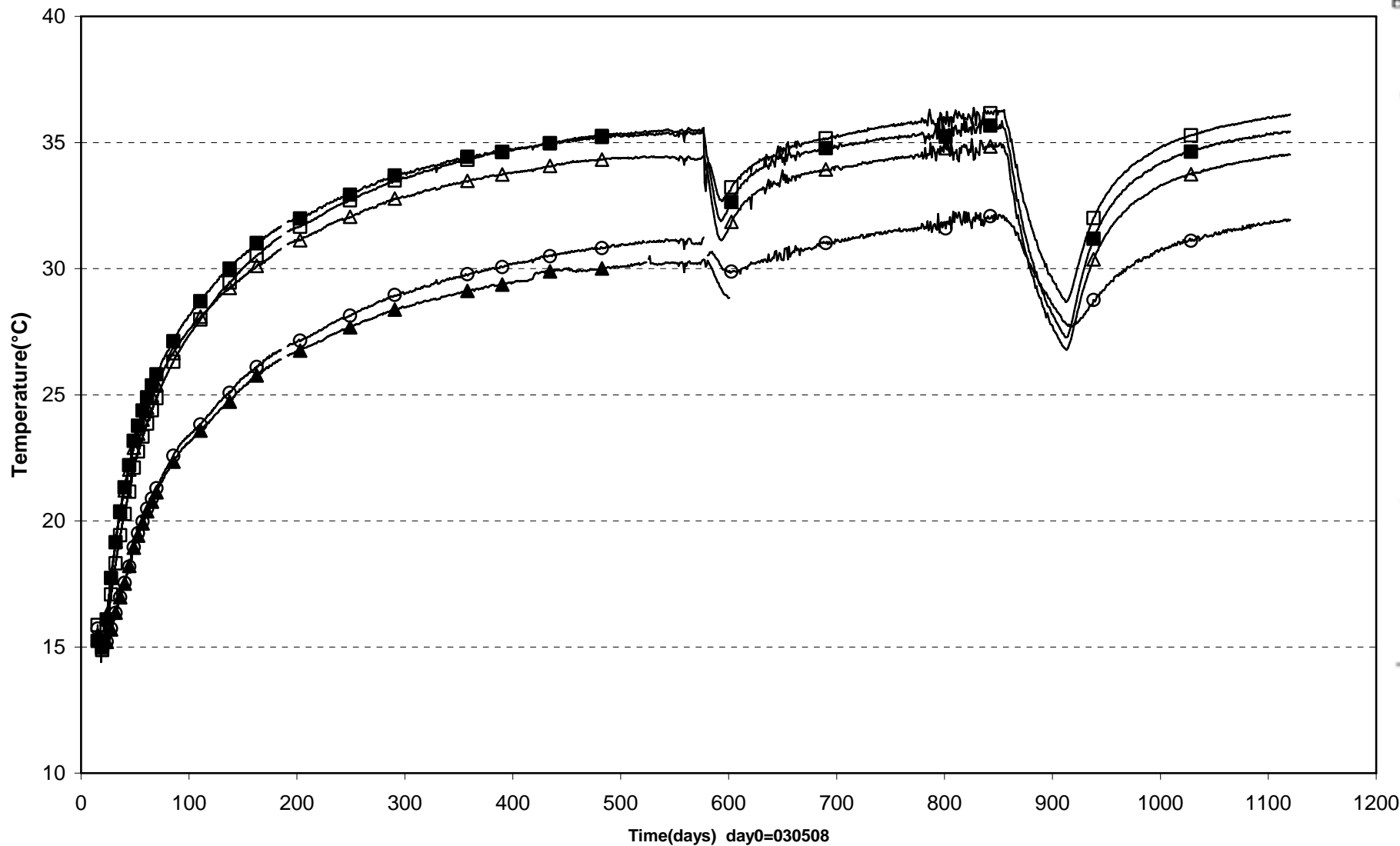
- ◆ TB612(2.795\270°\0.535)    ▲ TB613(2.795\270°\0.585)    □ TB614(2.795\270°\0.635)    ◇ TB615(2.795\270°\0.685)    △ TB616(2.795\270°\0.735)
- TB617(2.795\270°\0.785)    × TB618(2.753\270°\0.875)    ○ TB619(2.753\ 0°\0.525)

Prototype\Hole 6 \Ring8 (030508-060601)  
 Temperature - Pentronic

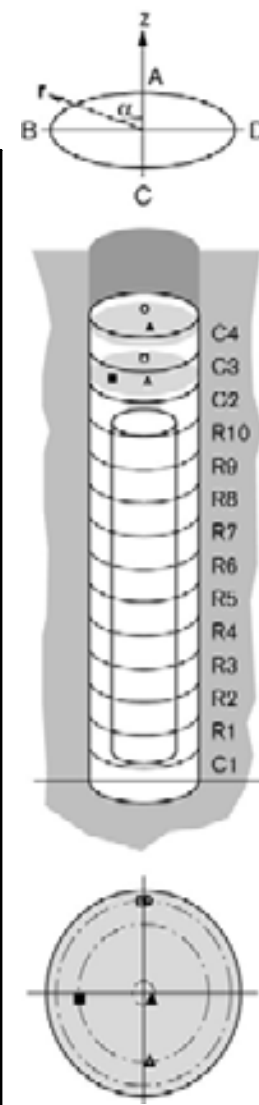


□ TB620(4.324\270°\0.535) ■ TB621(4.324\270°\0.585) ◇ TB622(4.324\270°\0.635) ◆ TB623(4.324\270°\0.685)  
 △ TB624(4.324\270°\0.735) ▲ TB625(4.324\270°\0.785) ○ TB626(4.253\270°\0.875) ● TB627(4.253\0°\0.525)

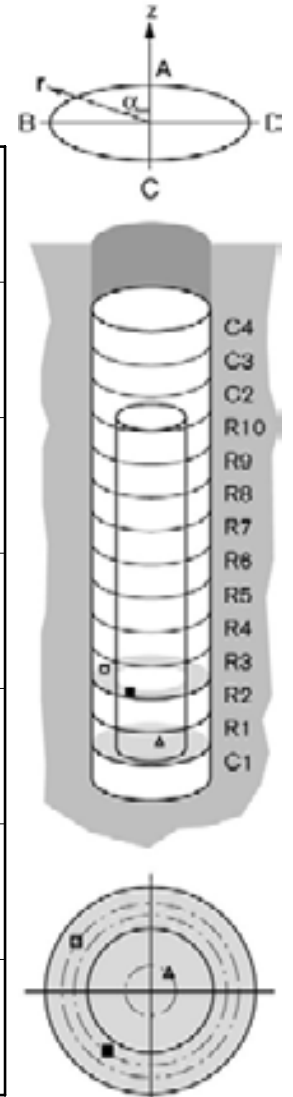
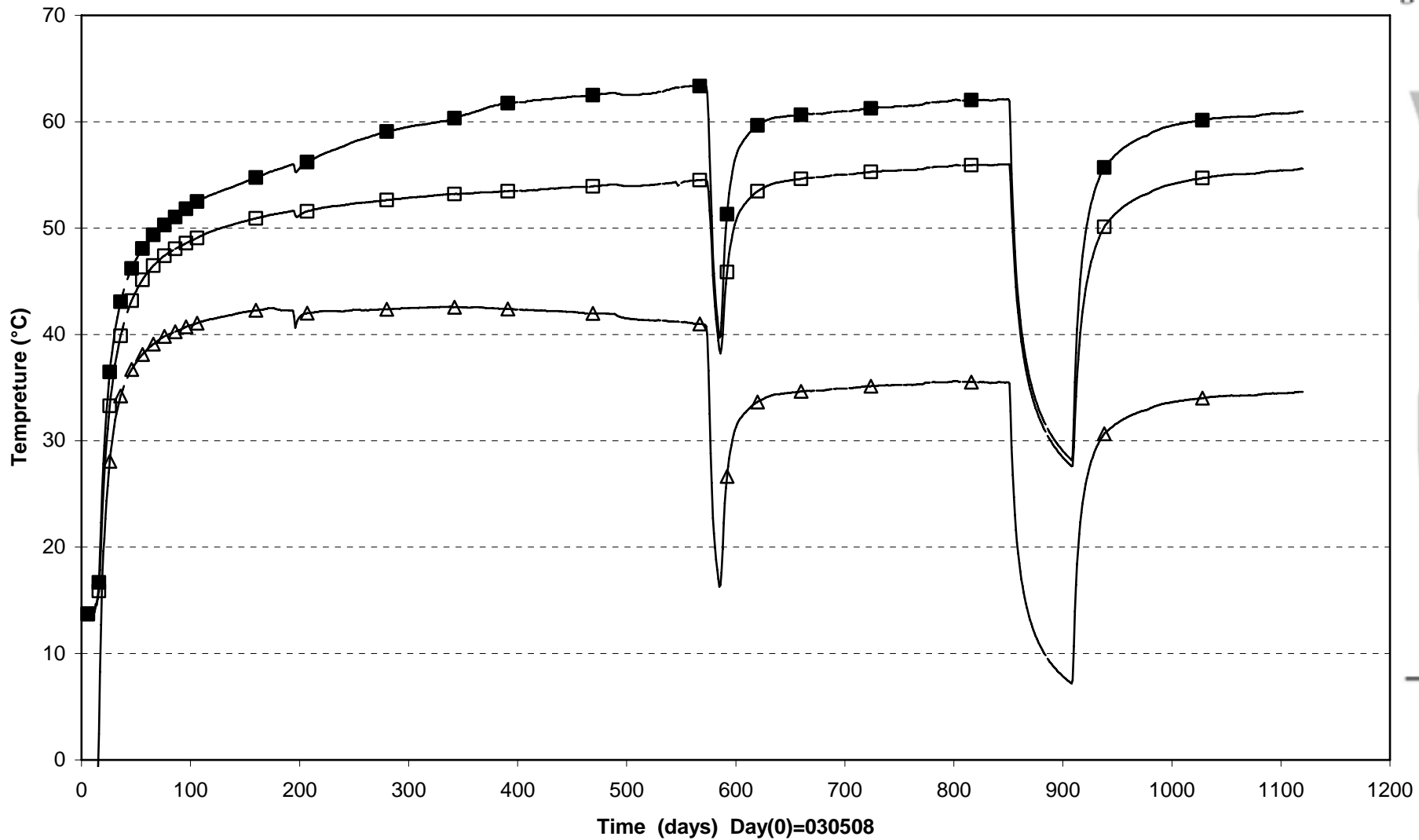
Prototype\Hole 6 \Cyl.3 and Cyl.4 (030508-060601)  
 Temperature - Pentronic



□ TB628(6.366\0°\0.785) ■ TB629(6.366\95°\0.585) △ TB630(6.366\185°\0.585) ▲ TB631(7.071\225°\0.100) ○ TB632(7.071\0°\0.785)

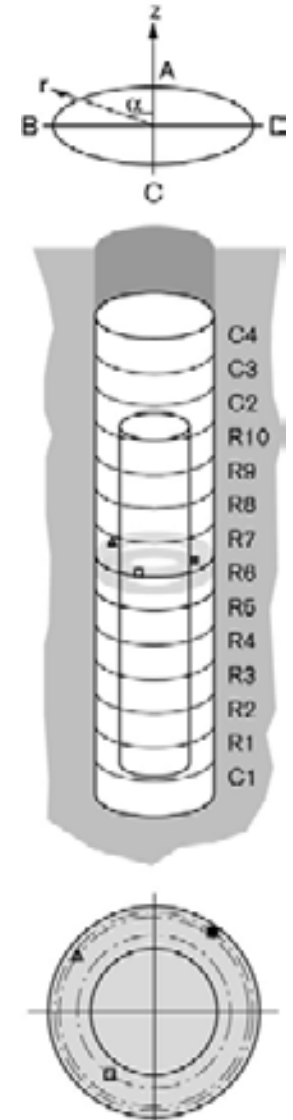
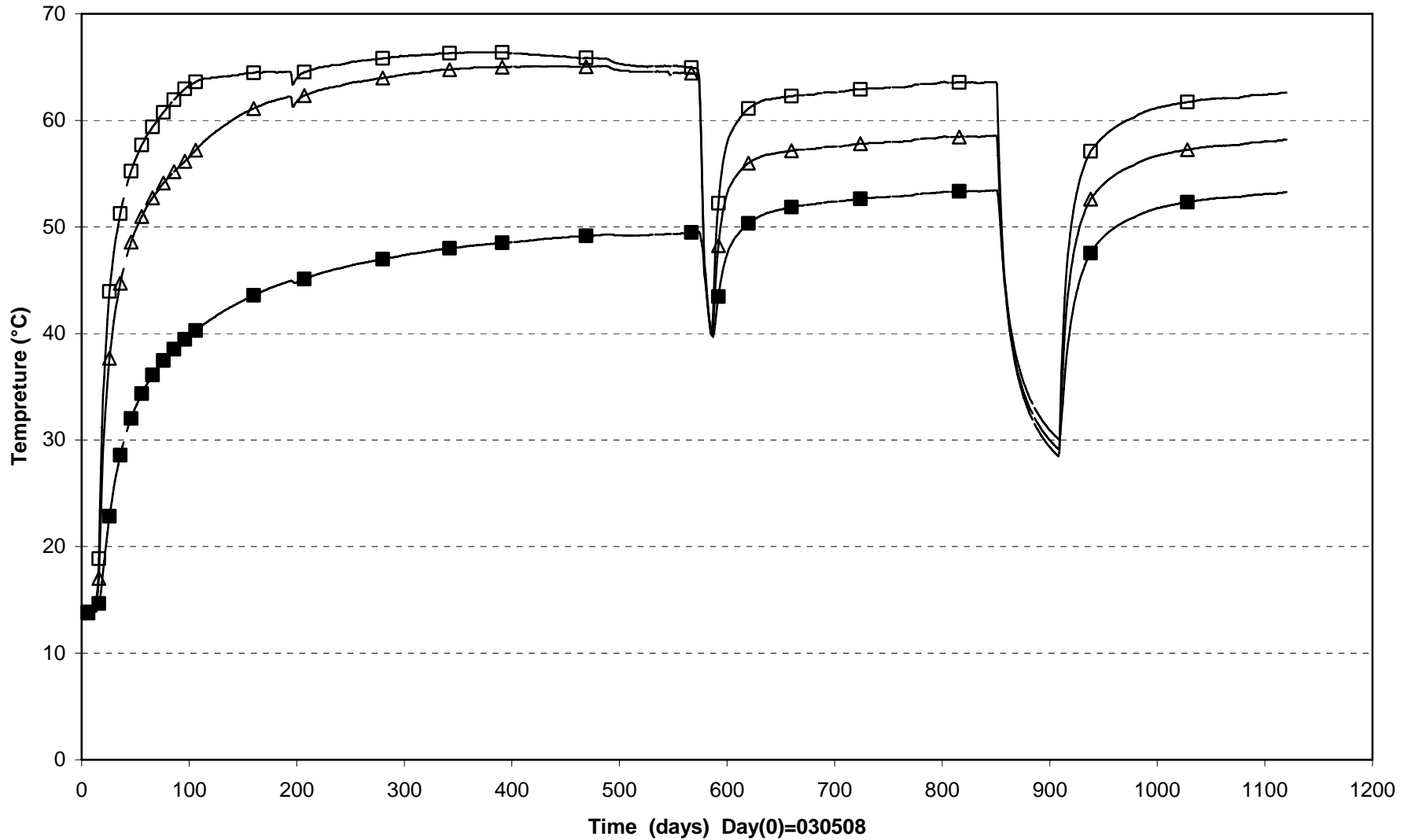


Prototype\Hole 6\Cyl.1 and Ring2 (030508-060601)  
 Temperature - Geokon



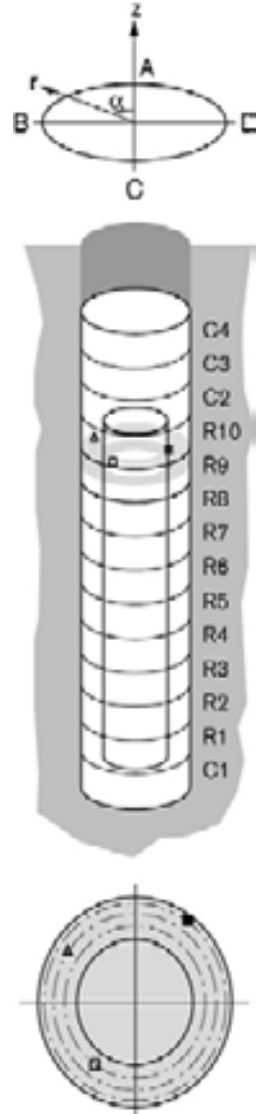
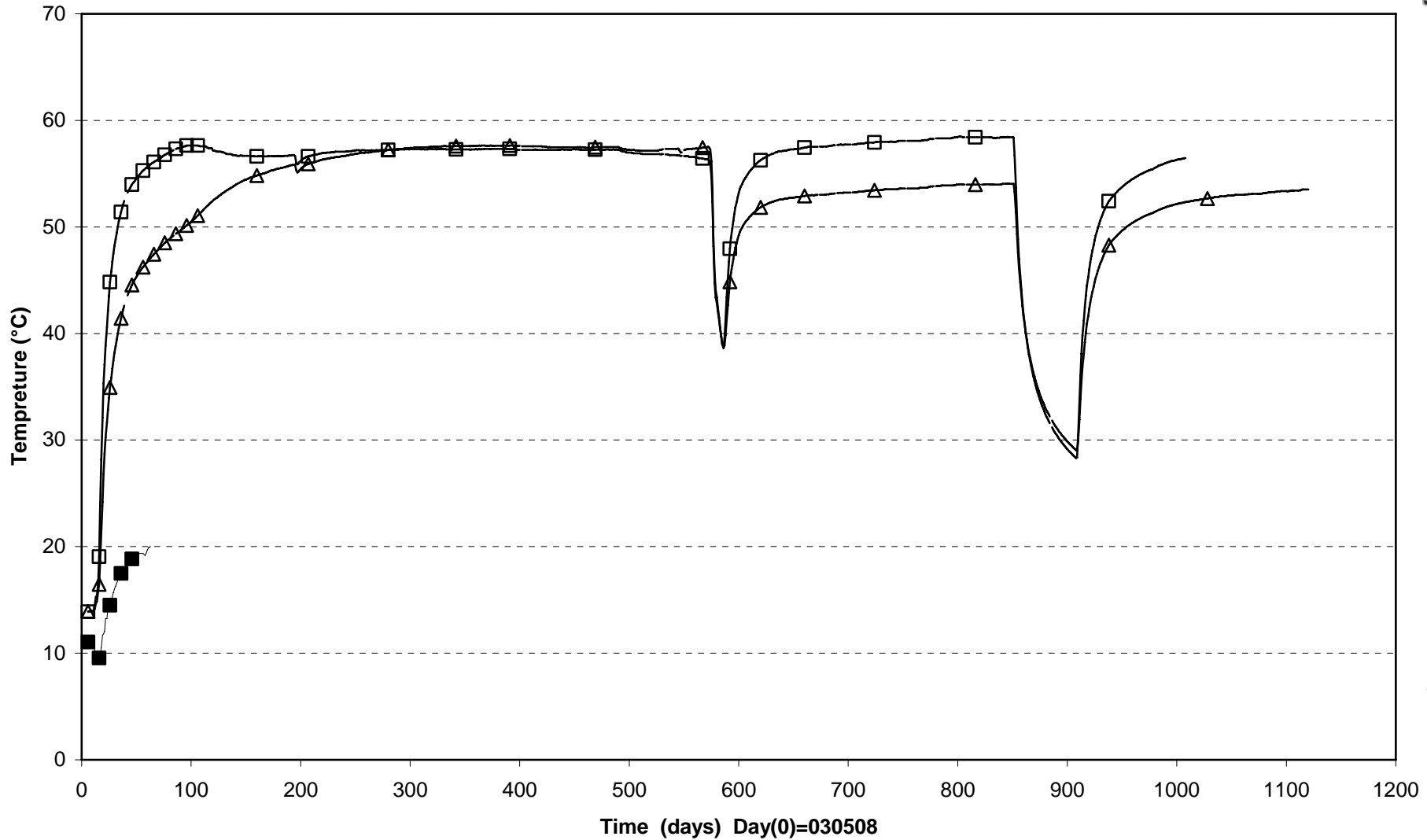
△ PB601T(0.510\315°\0.210)
□ PB606T(1.534\55°\0.735)
■ PB607T(1.534\145°\0.635)

Prototype\Hole 6\ Ring6 (030508-060601)  
 Temperature - Geokon



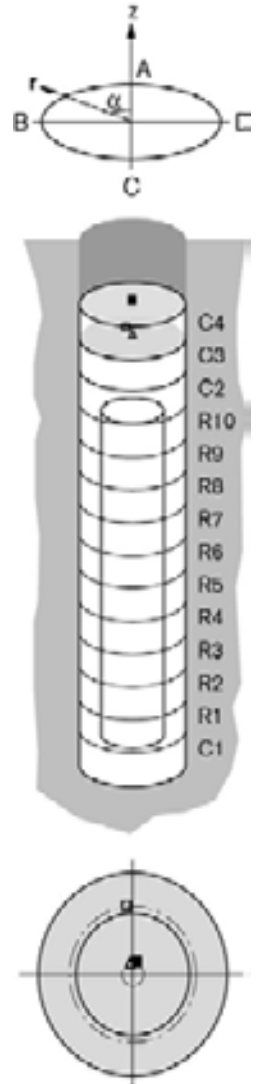
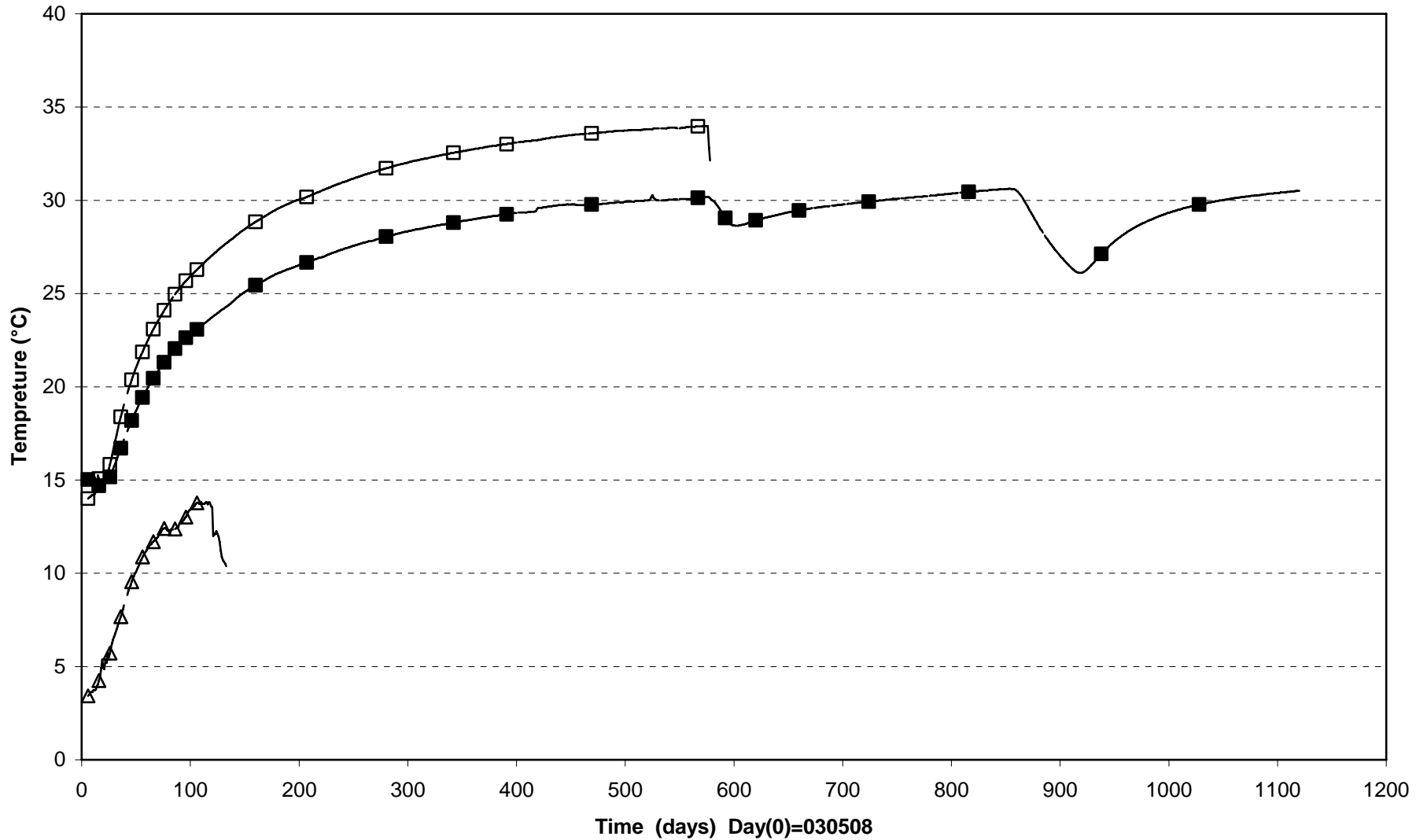
△ PB613T(3.550\55°\0.785)
□ PB614T(3.550\145°\0.635)
■ PB616T(3.253\325°\0.875)

Prototype\Hole 6\ Ring9 (030508-060601)  
 Temperature - Geokon



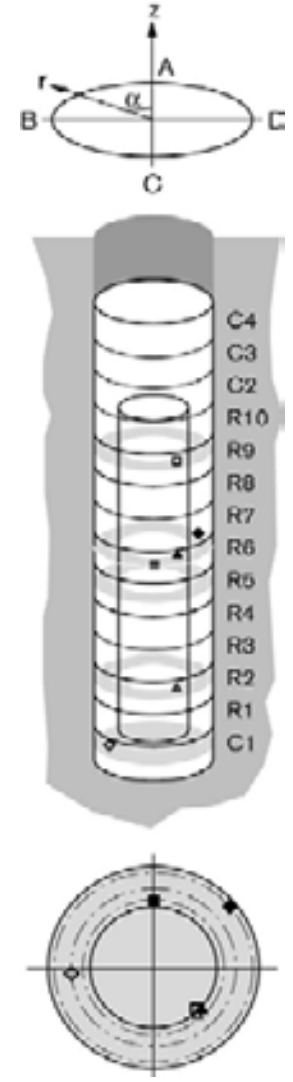
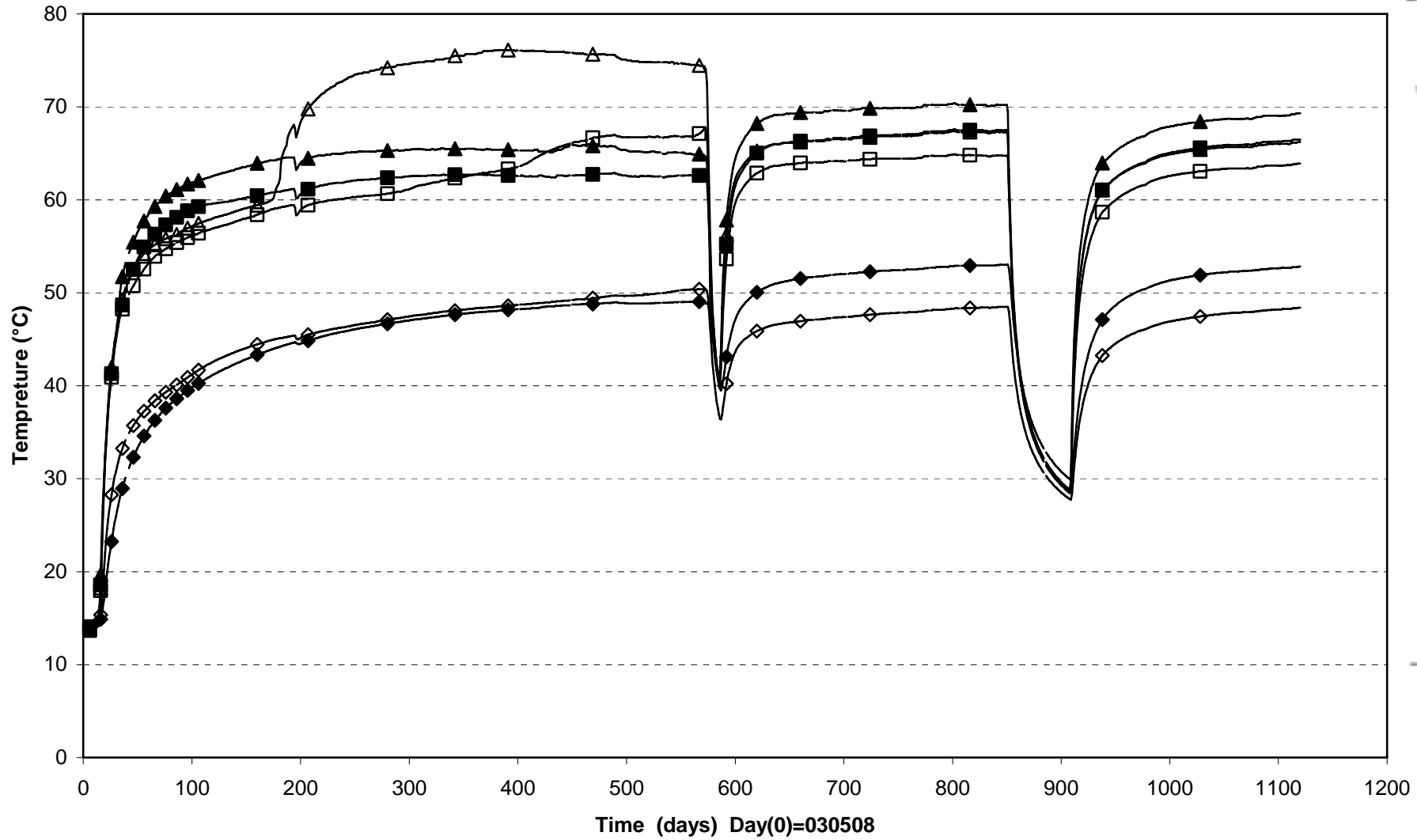
△ PB620T(5.084\55°\0.735)
□ PB621T(5.084\145°\0.635)
■ PB623T(4.753\325°\0.875)

Prototype\Hole 6\Cyl.3 and Cyl.4 (030508-060601)  
 Temperature - Geokon



△ PB625T(6.616\0°\0.100)
□ PB626T(6.616\5°\0.585)
■ PB627T(7.121\0°\0.100)

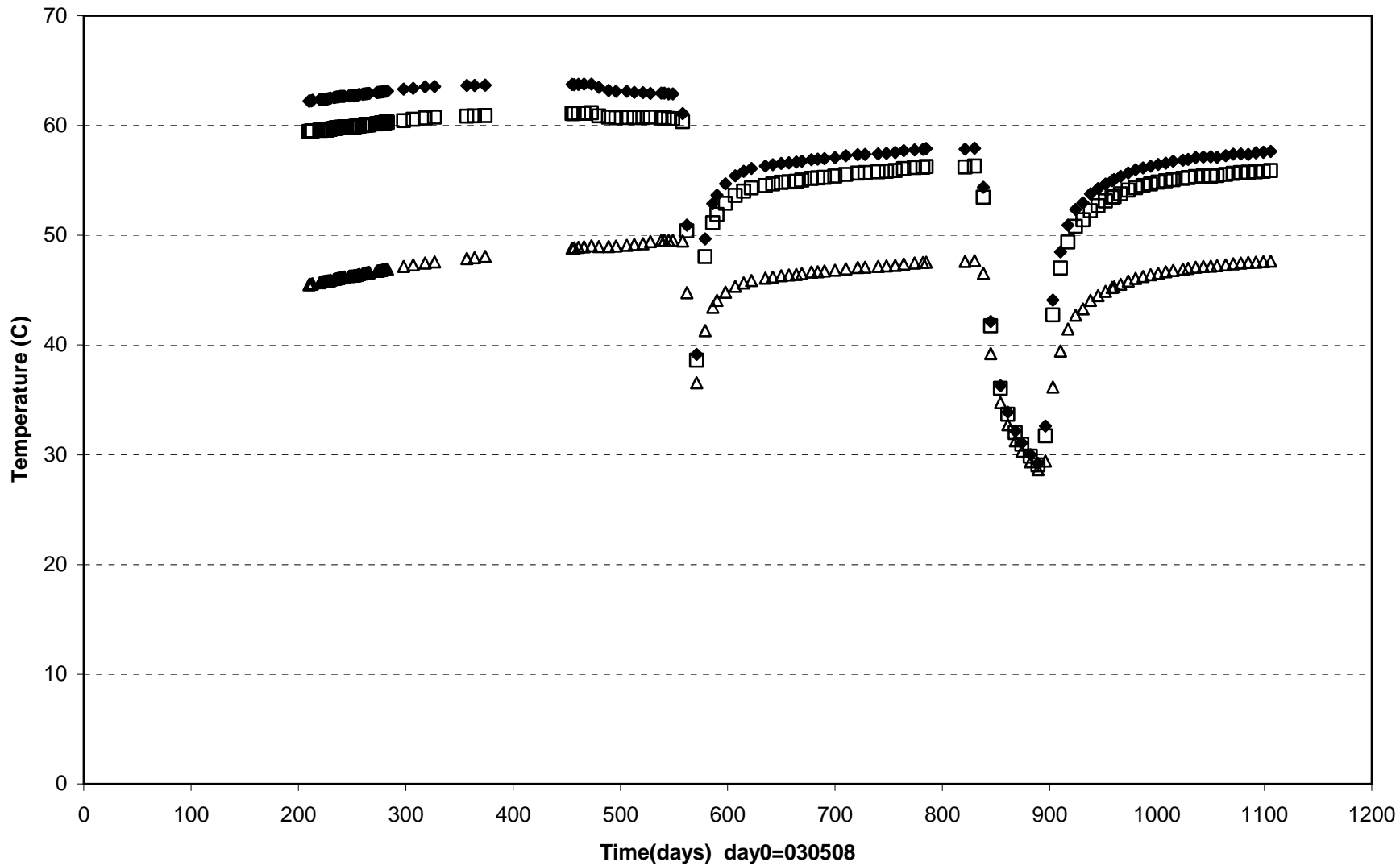
Prototype\Hole6 (030508-060601)  
Temperature- Geokon



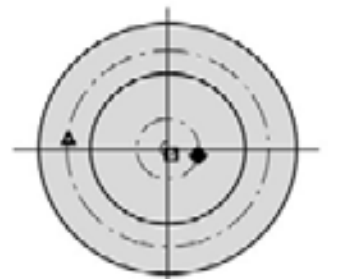
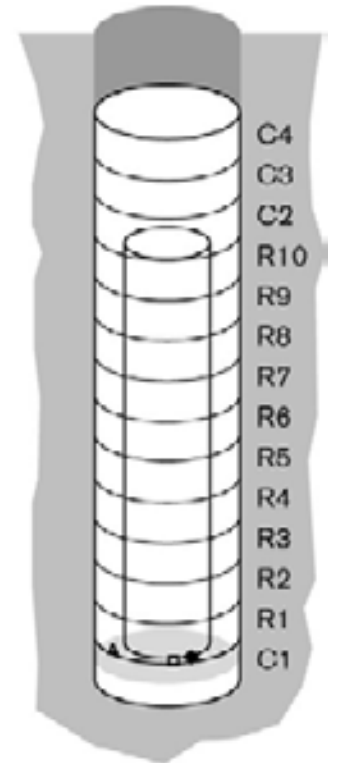
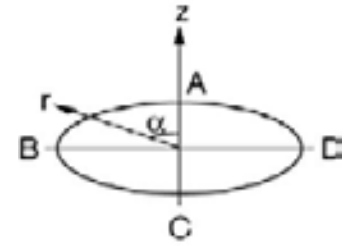
◇ UB602T(0.260\95°\0.685)	△ UB603T(1.284\225°\0.535)	■ UB605T(2.795\190°\0.585)
▲ UB609T(3.300\225°\0.535)	◆ UB610T(3.253\310°\0.875)	□ UB611T(4.834\225°\0.535)



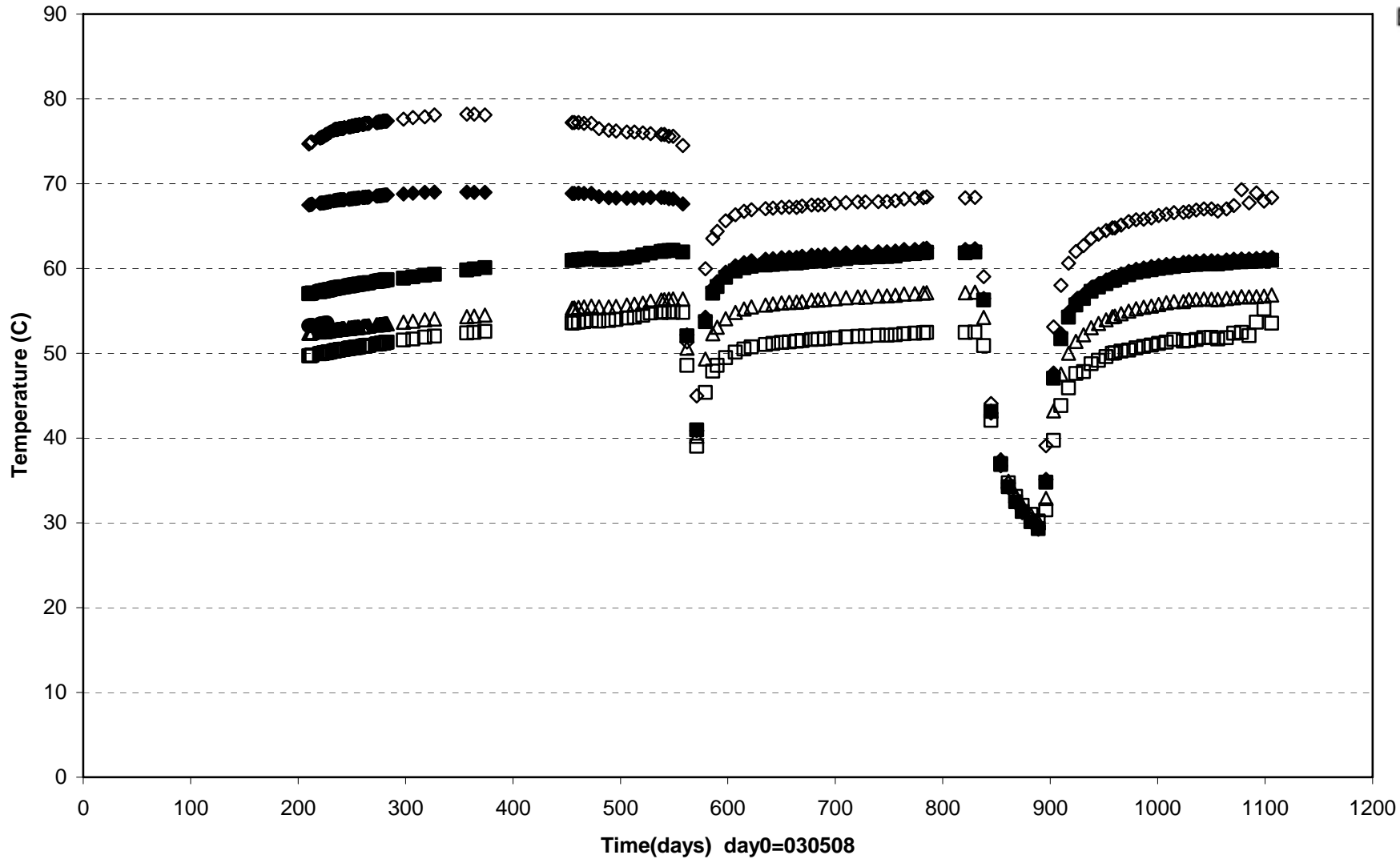
Prototype\ Hole 6 \ Cyl1 (030508-060601)  
 Temperature - Wescor



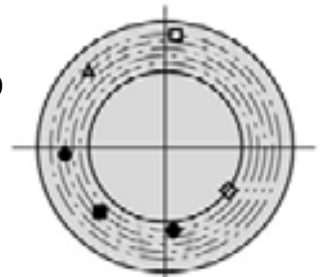
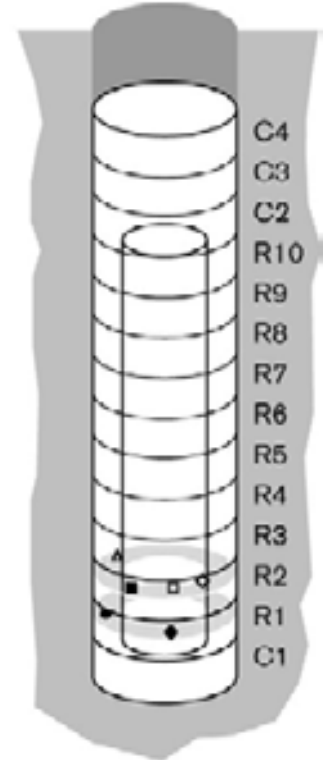
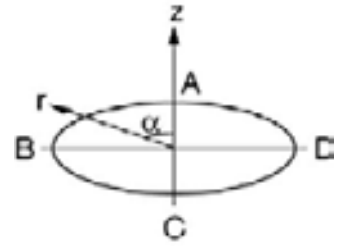
□ WB602T(0.260\225°\0.050) ♦ WB603T(0.260\260°\0.210) △ WB605T(0.260\90°\0.685)



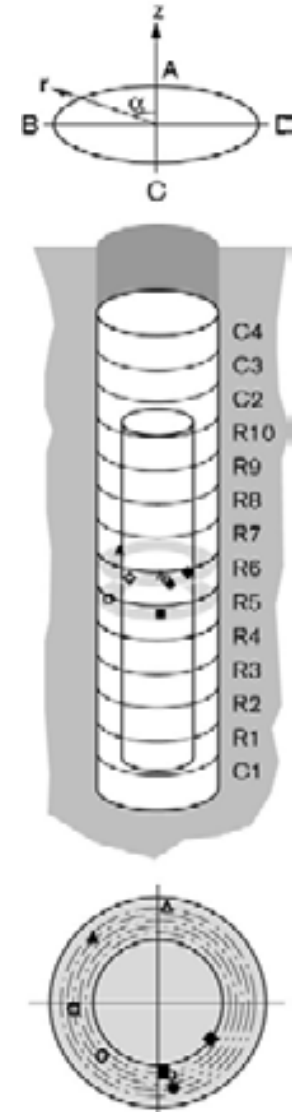
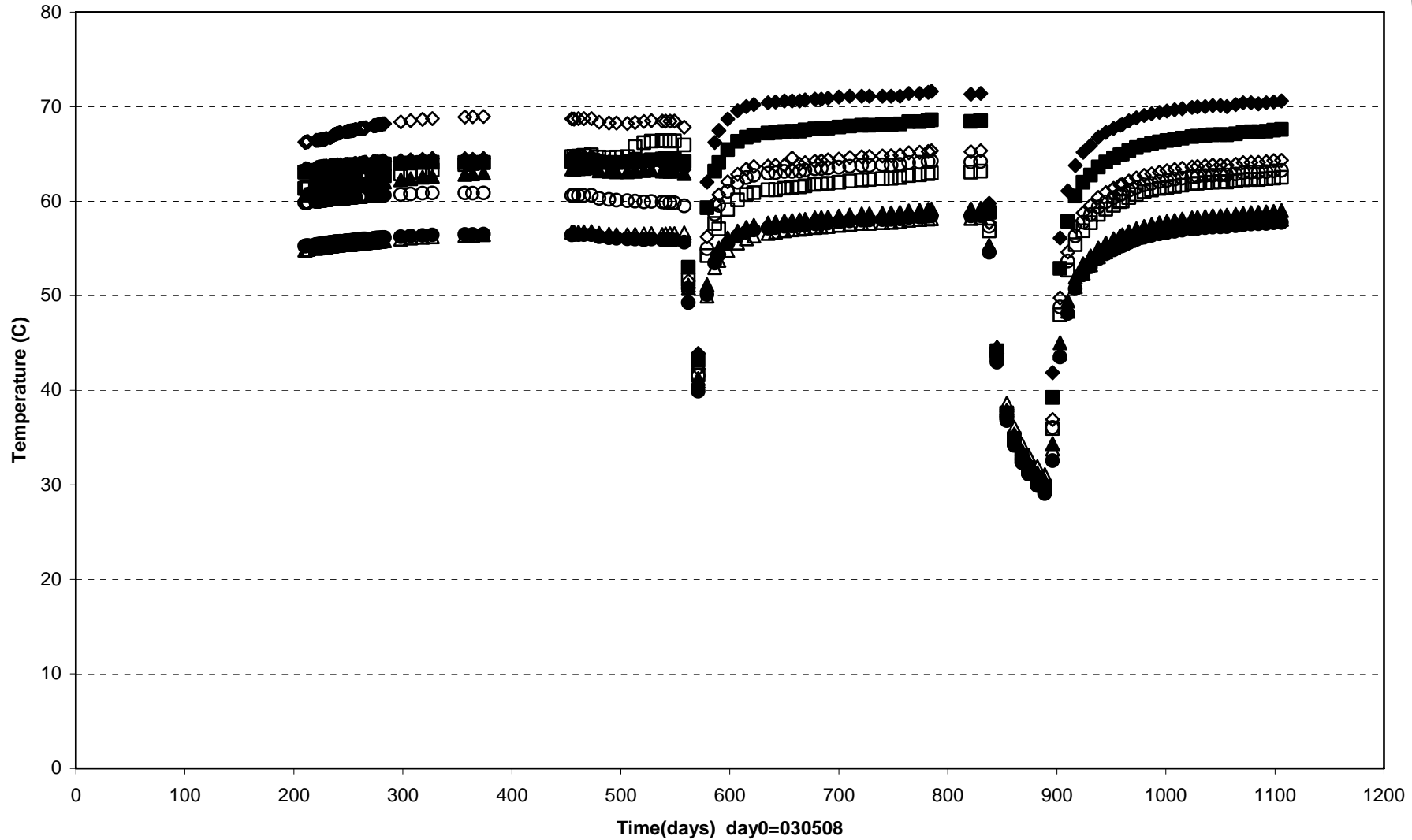
Prototype\ Hole 6 \ Ring 1 and Ring 2 (030508-060601)  
 Temperature - Wescor



- WB608T(0.770\95°\0.685)
- ◆ WB612T(0.750\185°\0.585)
- WB611T(0.770\355°\0.785)
- △ WB614T(1.284\45°\0.735)
- WB616T(1.284\135°\0.635)
- ◇ WB618T(1.284\235°\0.535)

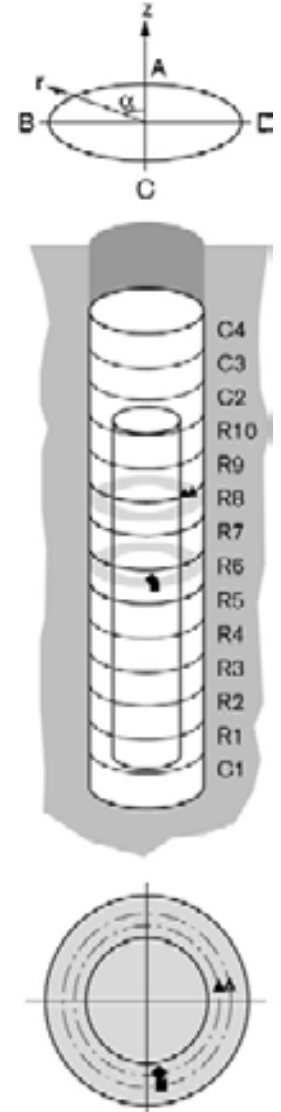
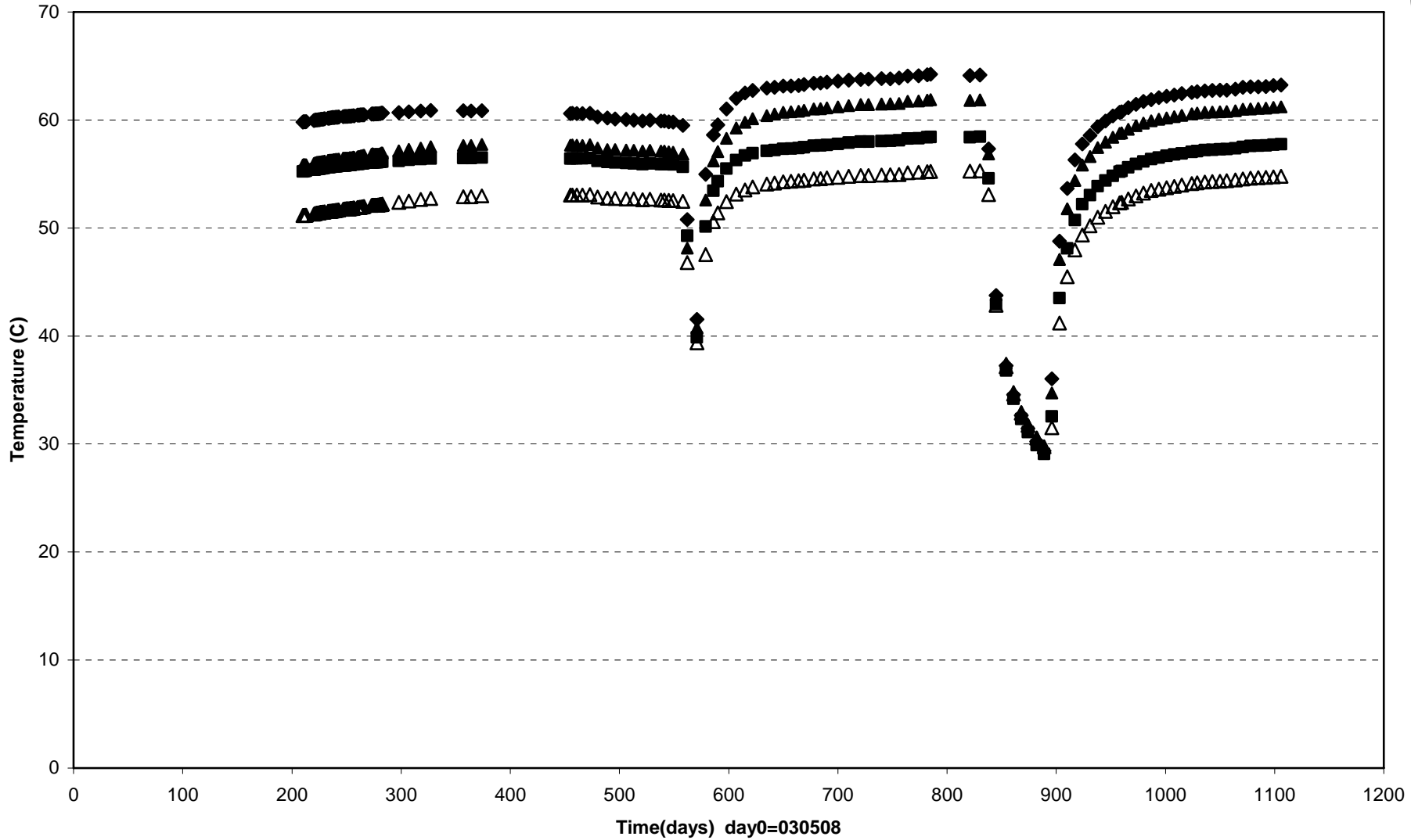


Prototype\ Hole 6 \ Ring 5 and Ring 6 (030508-060601)  
 Temperature - Wescor



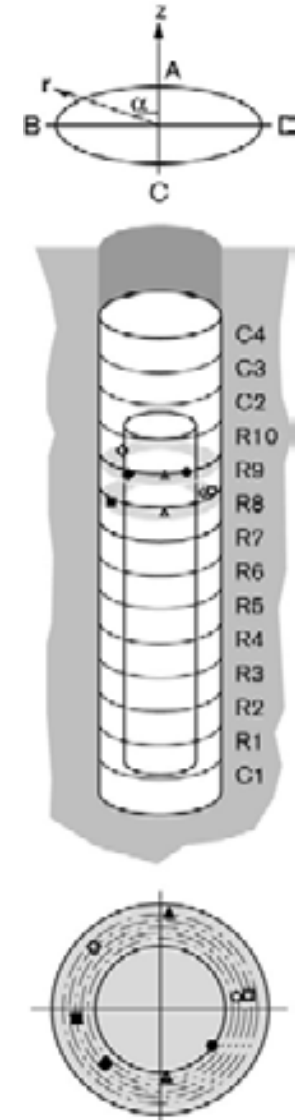
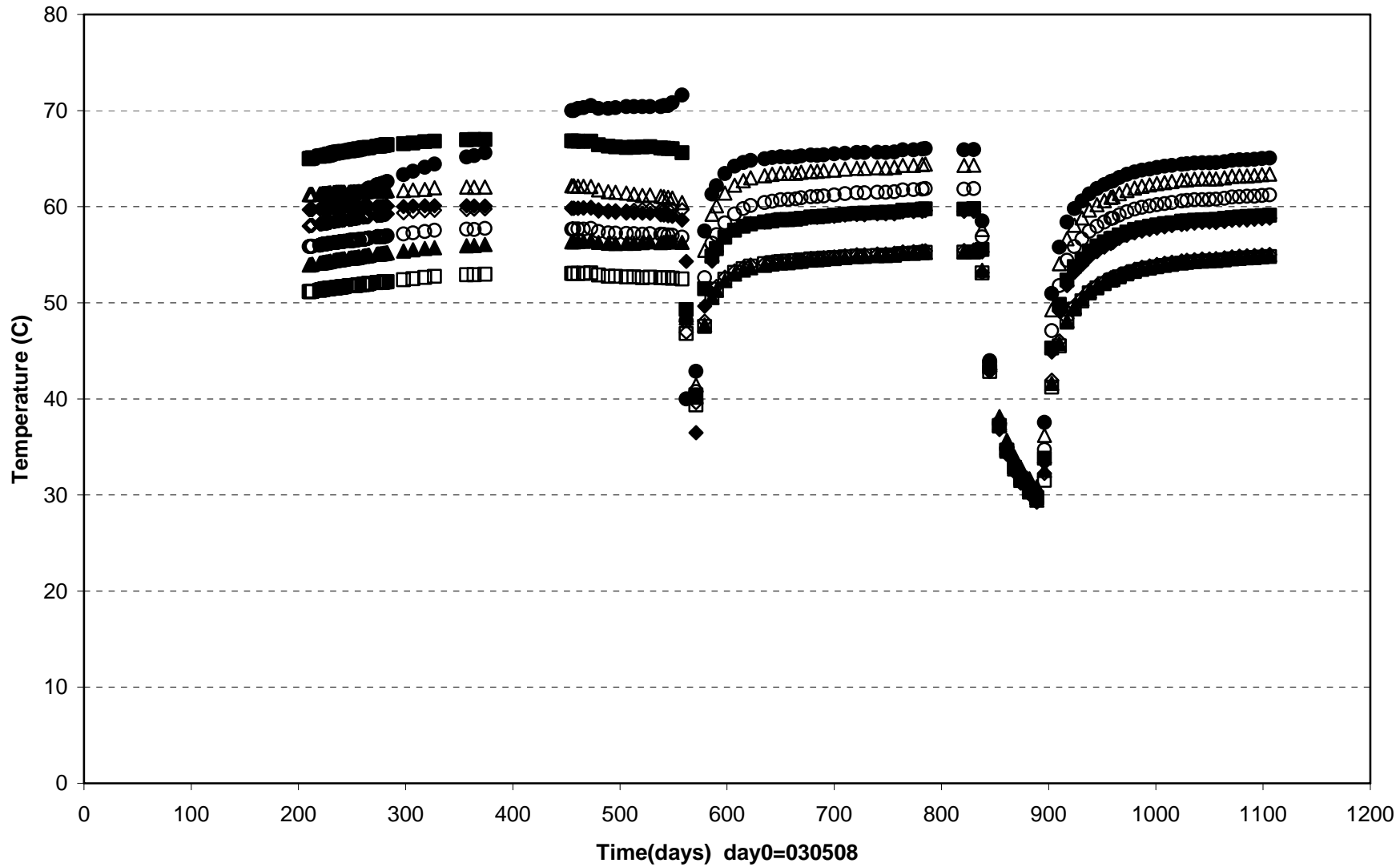
- WB622T(2.795\95°\0.685)    ■ WB624T(2.795\185°\0.585)    △ WB625T(2.795\355°\0.785)    ▲ WB628T(3.300\45°\0.735)
- ◇ WB630T(3.300\135°\0.635)    ◆ WB632T(3.300\235°\0.535)    ○ WB657T(3.300\190°\0.625)    ● WB658T(3.300\190°\0.725)

Prototype\ Hole 6 \ Ring 6 and Ring 8 (030508-060601)  
 Temperature - Wescor



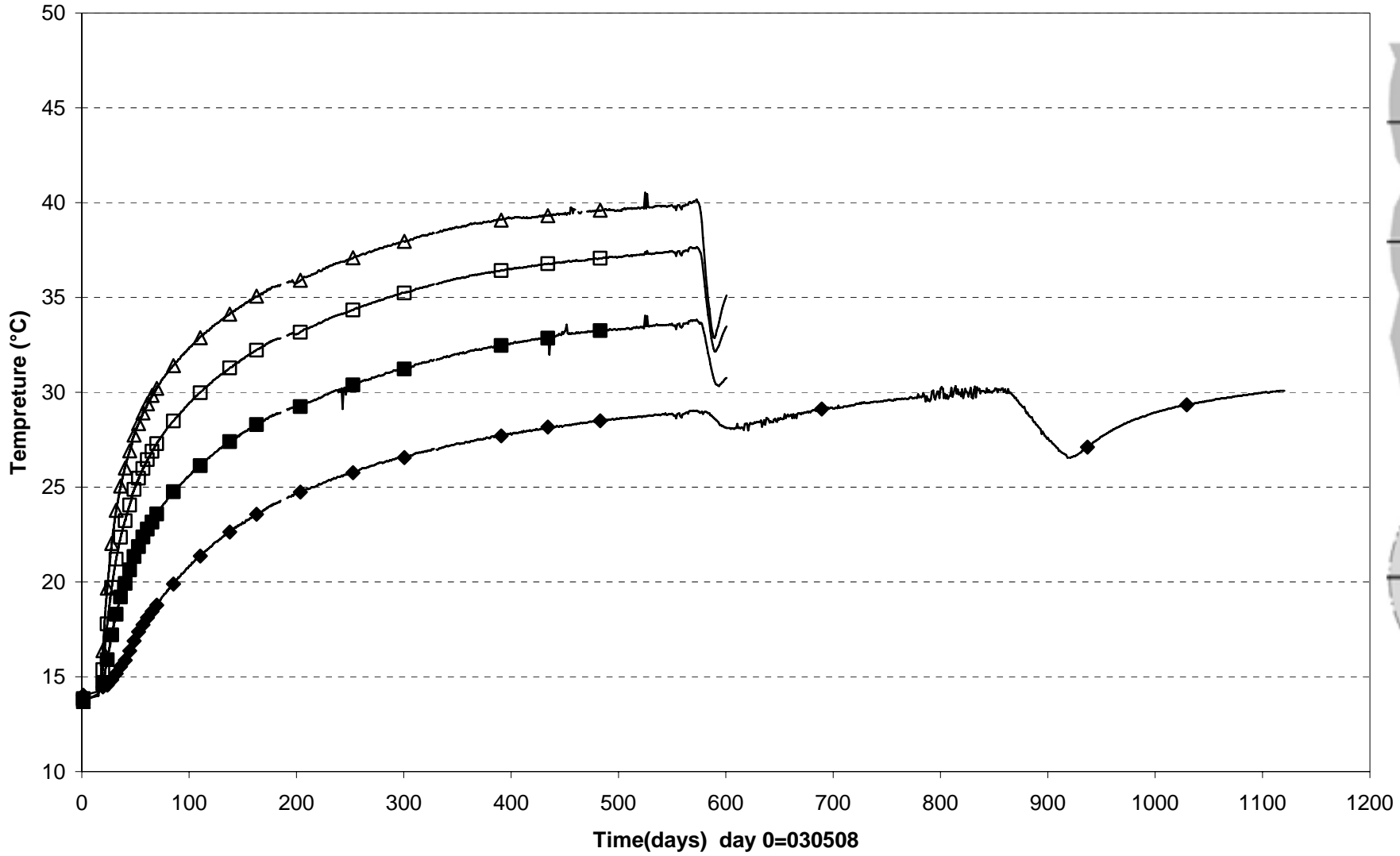
◆ WB657T(3.300\190°\0.625) ■ WB658T(3.300\190°\0.725) ▲ WB662T(4.324\280°\0.625) ▾ WB663T(4.324\280°\0.725)

Prototype\ Hole 6 \ Ring 8 and Ring 9 (030508-060601)  
 Temperature - Wescor

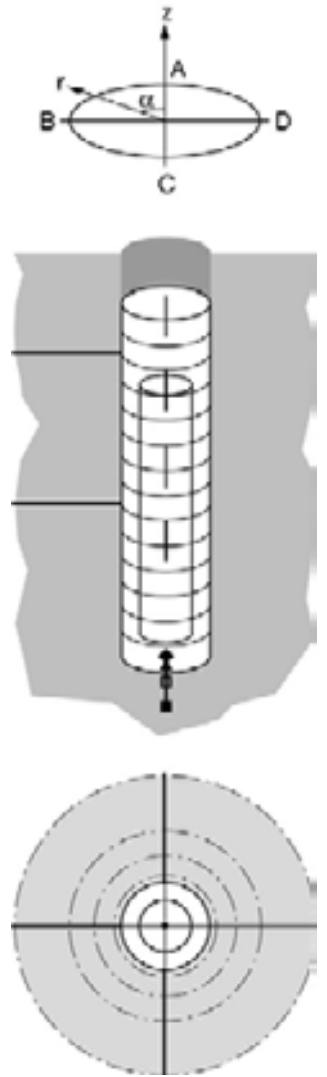


- WB636T(4.324\95°\0.685)    △ WB638T(4.324\185°\0.585)    ▲ WB639T(4.324\355°\0.785)    ◇ WB642T(4.834\45°\0.735)
- ◆ WB644T(4.834\135°\0.635)    ● WB646T(4.834\235°\0.535)    ○ WB662T(4.324\280°\0.625)    □ WB663T(4.324\280°\0.725)

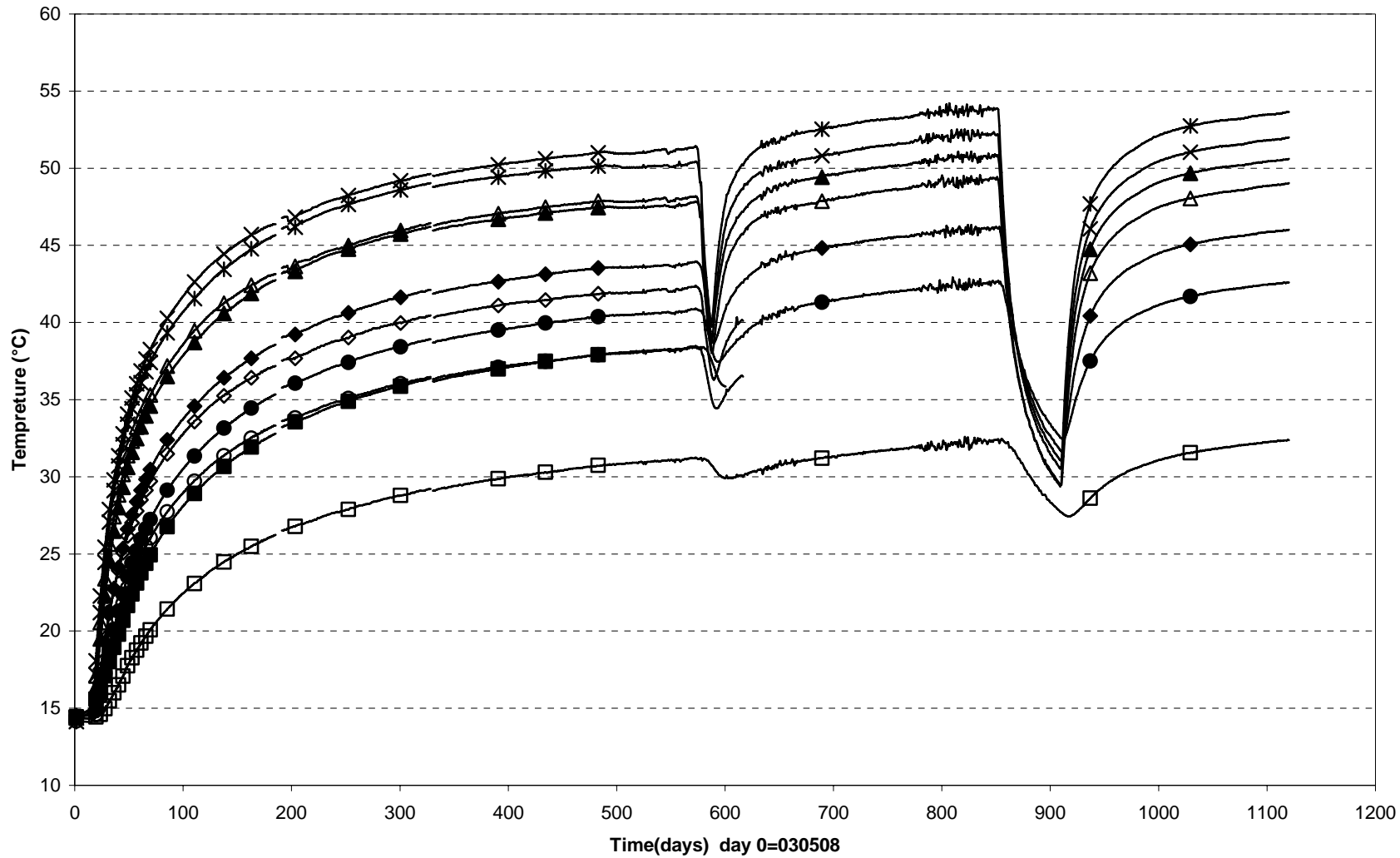
Prototype\Rock\Hole 6\ Level bottom (030508-060601)  
 Temperature - Pentronic



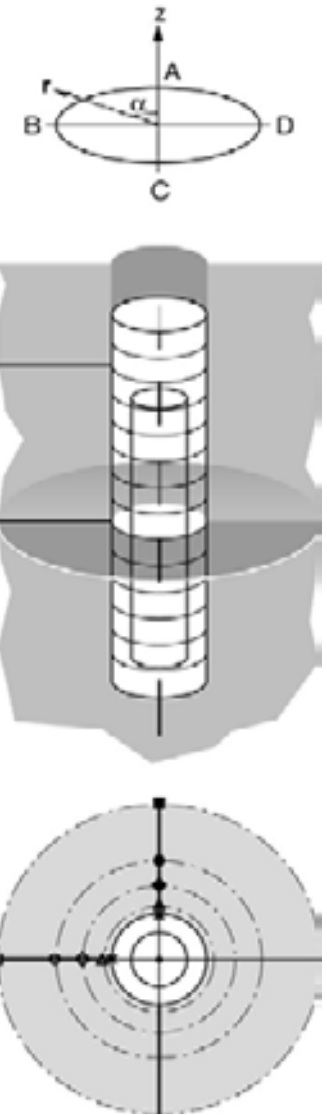
■ TR6011(-1.00°\ 0.0) □ TR6012(-0.50°\ 0.0) △ TR6013(-0.20°\ 0.0) ◆ TR6014(0.00°\ 0.0)



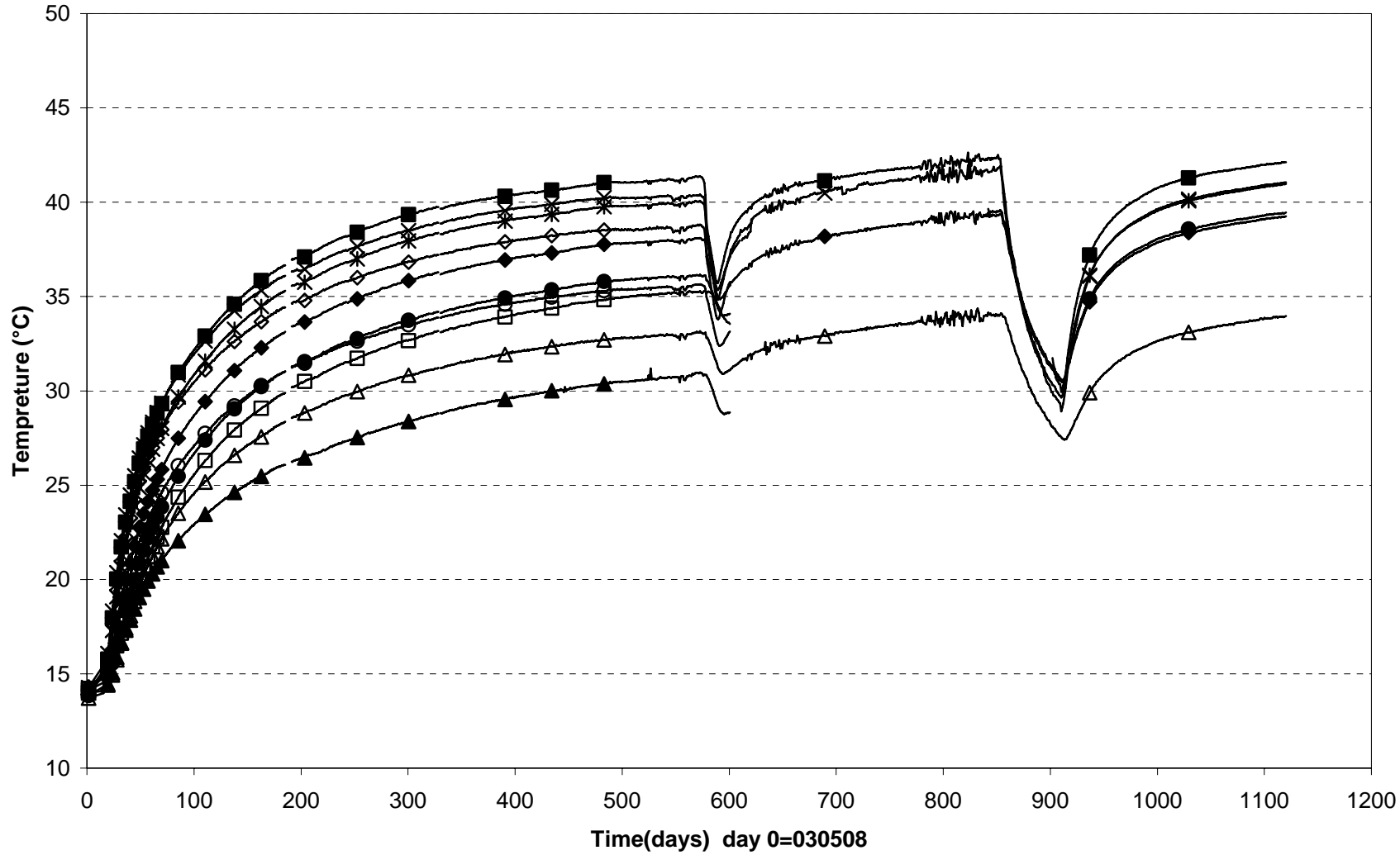
Prototype\Rock\Hole 6 \ Level 3,0 m (030508-060601)  
 Temperature - Pentronic



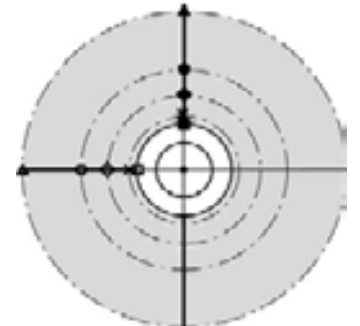
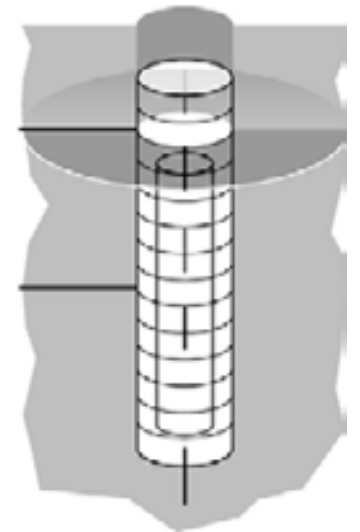
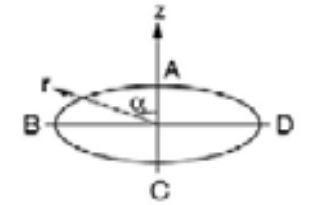
- TR6041(3.0\79°\ 3.075)    ○ TR6042(3.0\79°\ 1.975)    ◇ TR6043(3.0\79°\ 1.475)    △ TR6044(3.0\79°\ 1.075)    × TR6045(3.0\79°\ 0.875)
- TR6051(3.0\347°\3.075)    ● TR6052(3.0\347°\1.975)    ◆ TR6053(3.0\347°\1.475)    ▲ TR6054(3.0\347°\1.075)    ✱ TR6055(3.0\347°\0.875)



Prototype\Rock\Hole 6\ Level 6,0 m (030508-060601)  
 Temperature - Pentronic

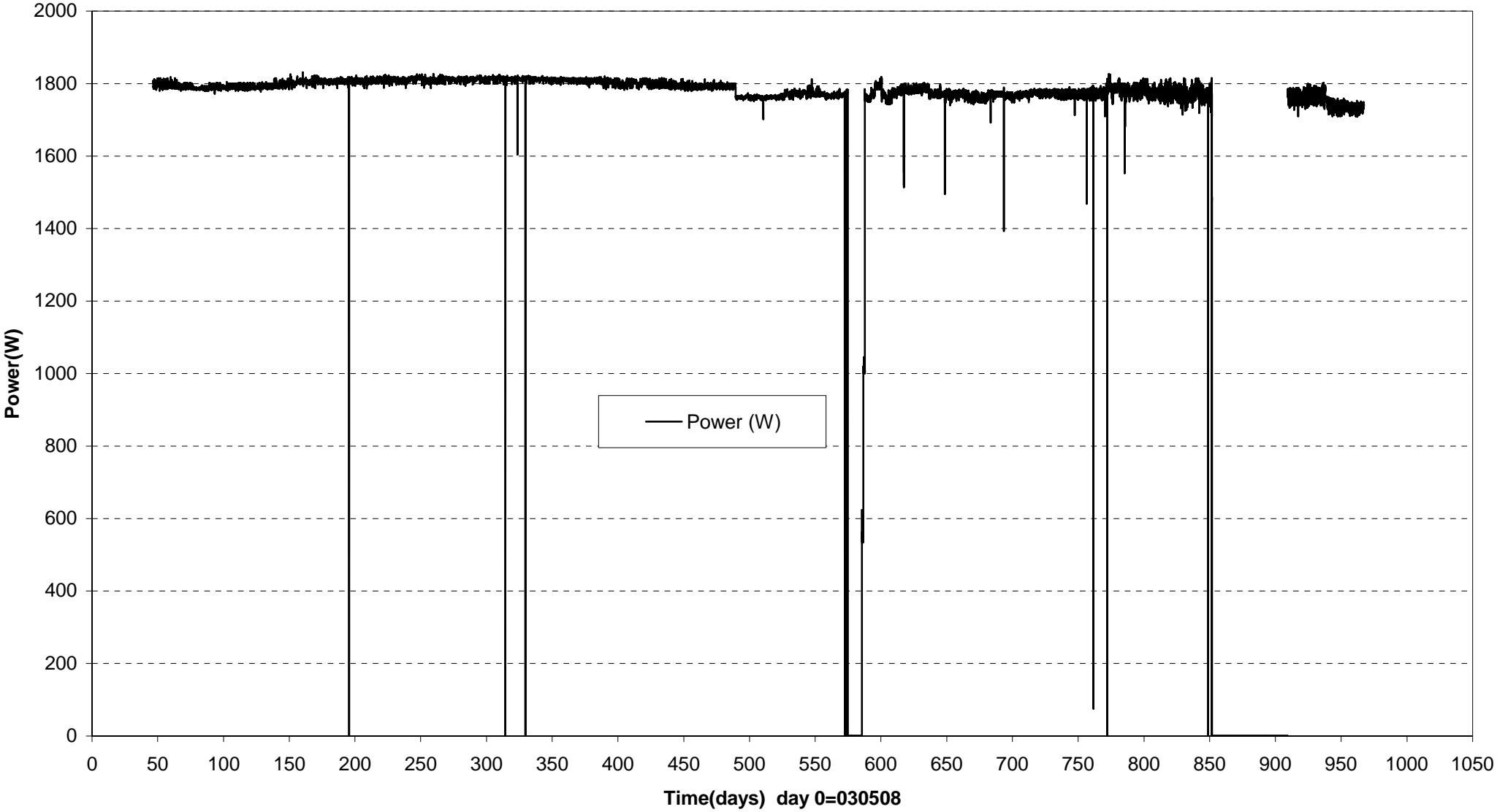


- |                           |                           |                           |                           |                           |
|---------------------------|---------------------------|---------------------------|---------------------------|---------------------------|
| △ TR6021(6.0\79°\ 3.075)  | ○ TR6022(6.0\79°\ 1.975)  | ◇ TR6023(6.0\79°\ 1.475)  | × TR6024(6.0\79°\ 1.075)  | □ TR6025(6.0\79°\ 0.875)  |
| ▲ TR6031(6.0\349°\ 3.075) | ● TR6032(6.0\349°\ 1.975) | ◆ TR6033(6.0\349°\ 1.475) | ✱ TR6034(6.0\349°\ 1.075) | ■ TR6035(6.0\349°\ 0.875) |

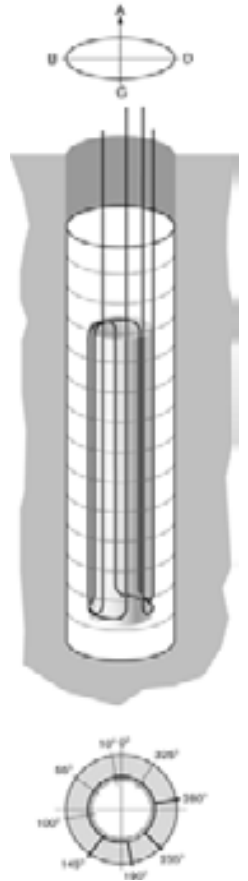
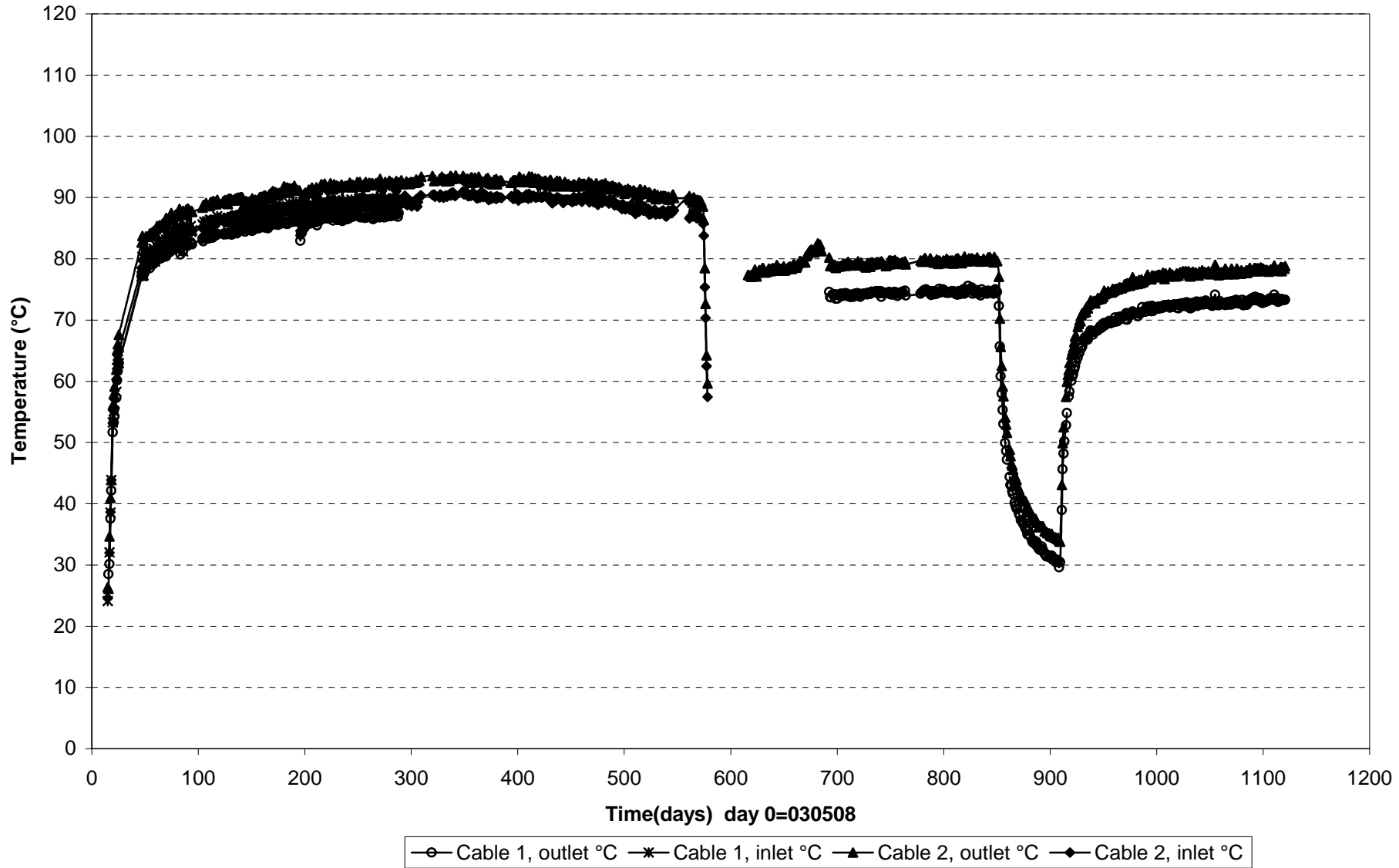




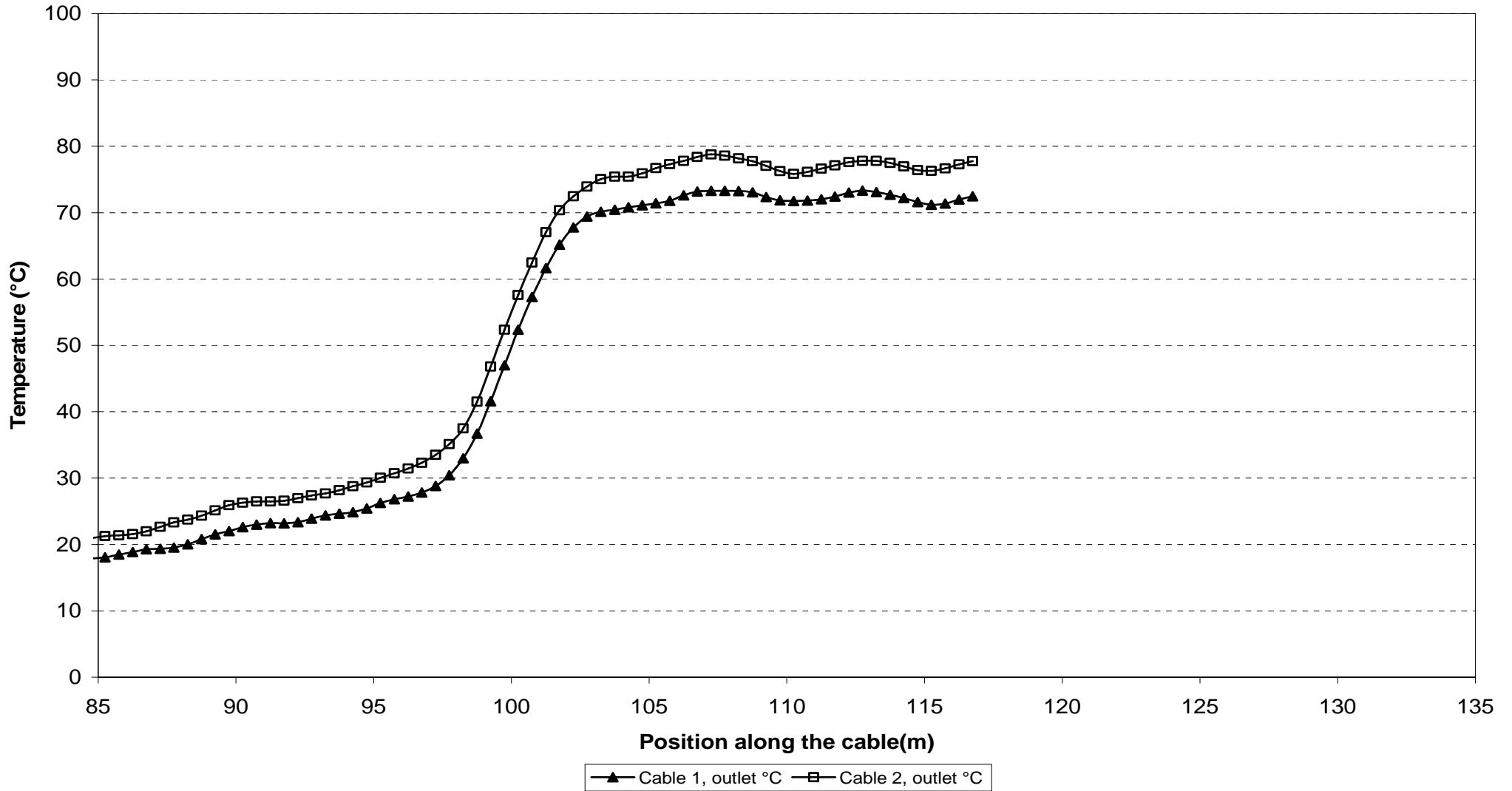
Prototype\Hole 6 (030508-060601)  
Canister power



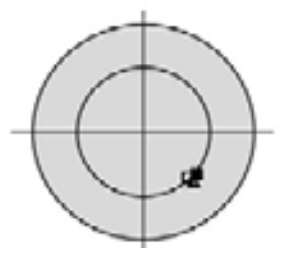
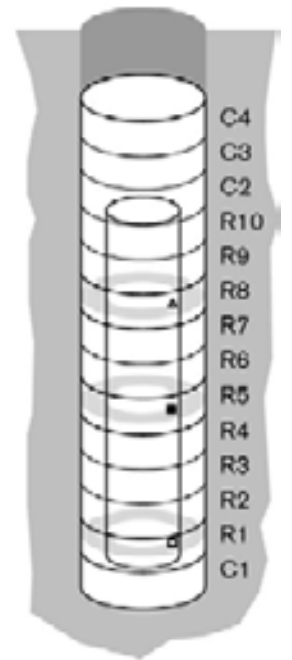
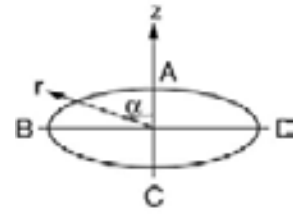
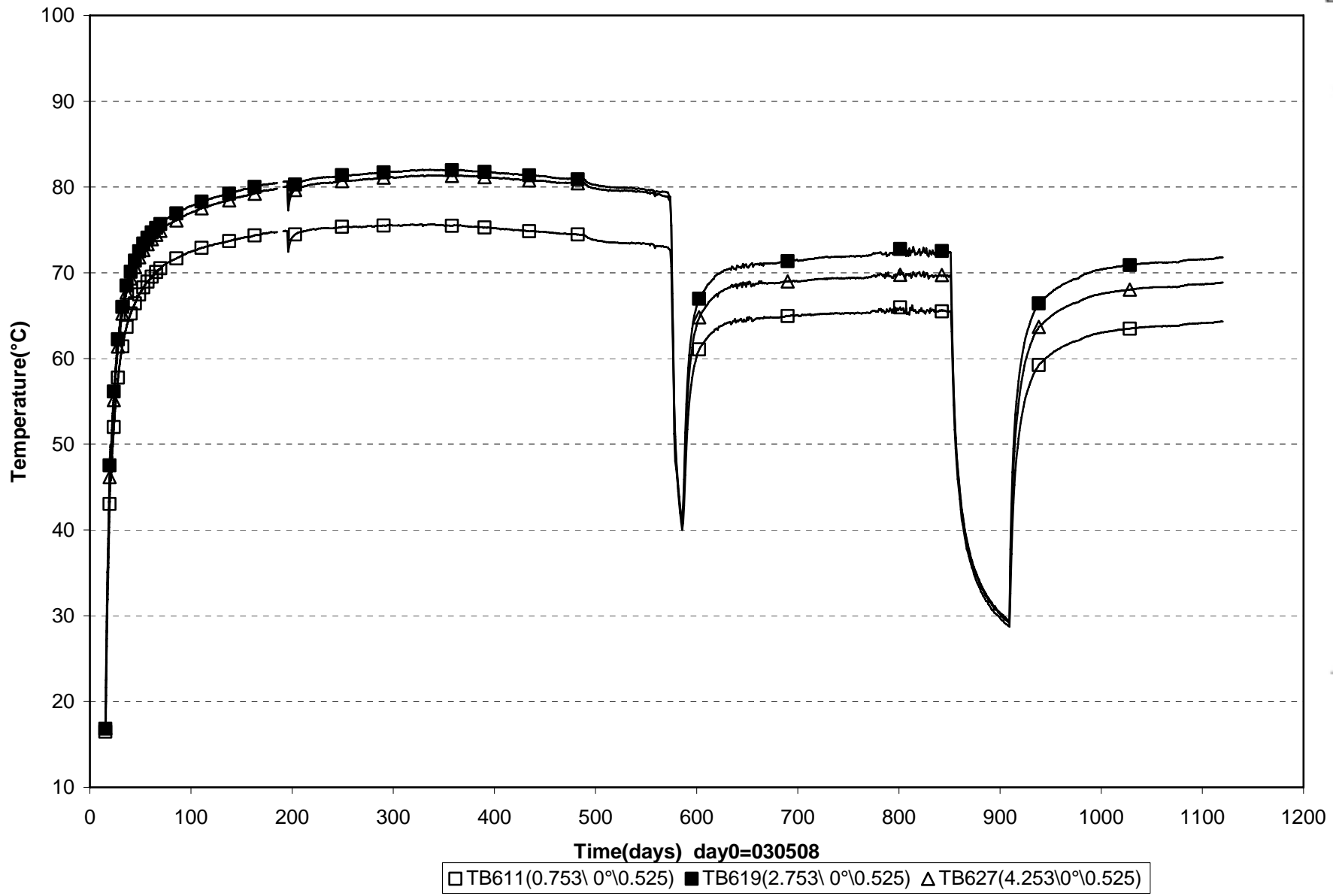
Prototype\ Hole 6 \Canister (030508-060601)  
 Max. temperature on the canister surface - Optical fiber cables



Temperature profile on the canister surface-No6 (060601)  
Optical fiber cables



Prototype\Hole 6 \On the canister surface (030508-060601)  
 Temperature - Pentronic

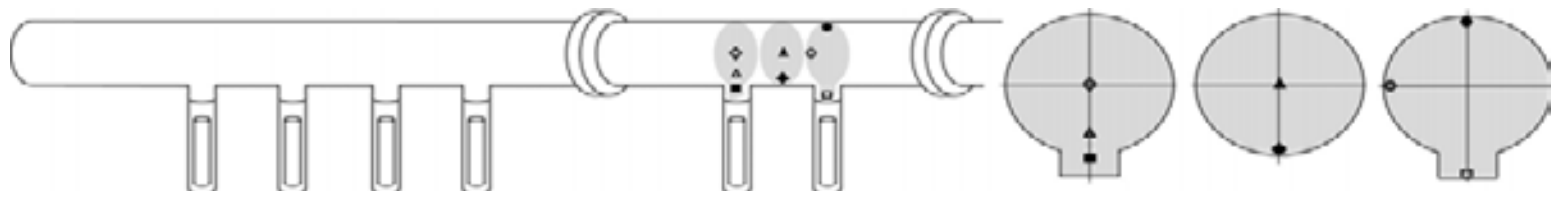
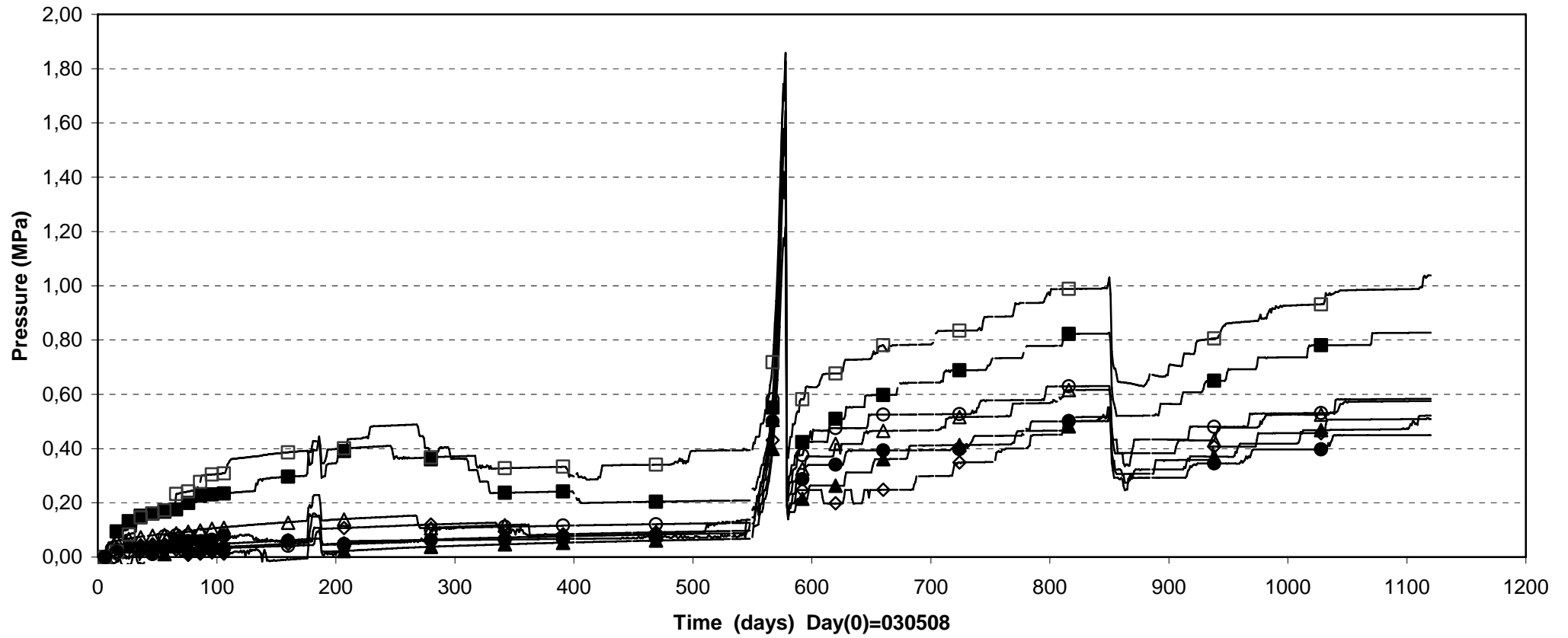


# **Appendix 7**

## **Backfill in section 2**

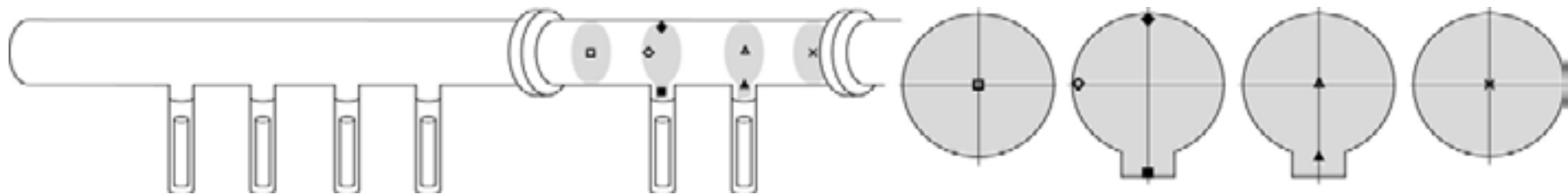
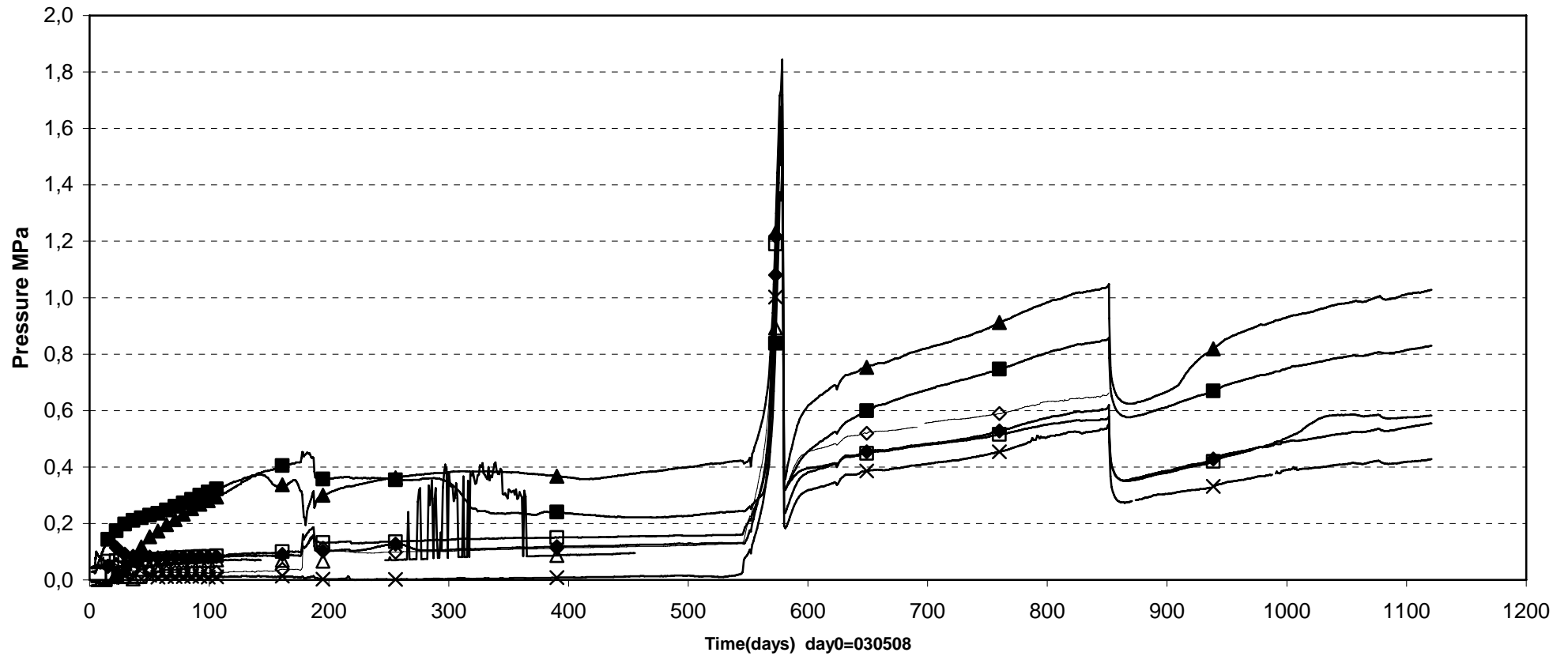


**Total pressure\ Backfill \ Section 2 (030508-060601)  
Geokon**



◇ PFA02 (E5\0\0\3551)	△ PFA03 (E5\0\1.75\3551)	■ PFA04 (E5\0\2.6\3551)
▲ PFA08 (F5-6\0\0\3548)	◆ PFA09 (F5-6\0\2.3\3548)	□ PFA13 (E6\0\3.15\3545)
○ PFA14 (E6\2.3\0\3545)	● PFA15 (E6\0\2.3\3545)	

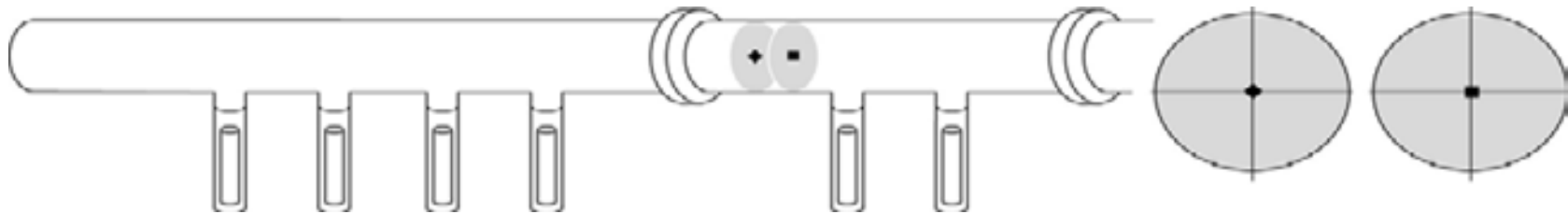
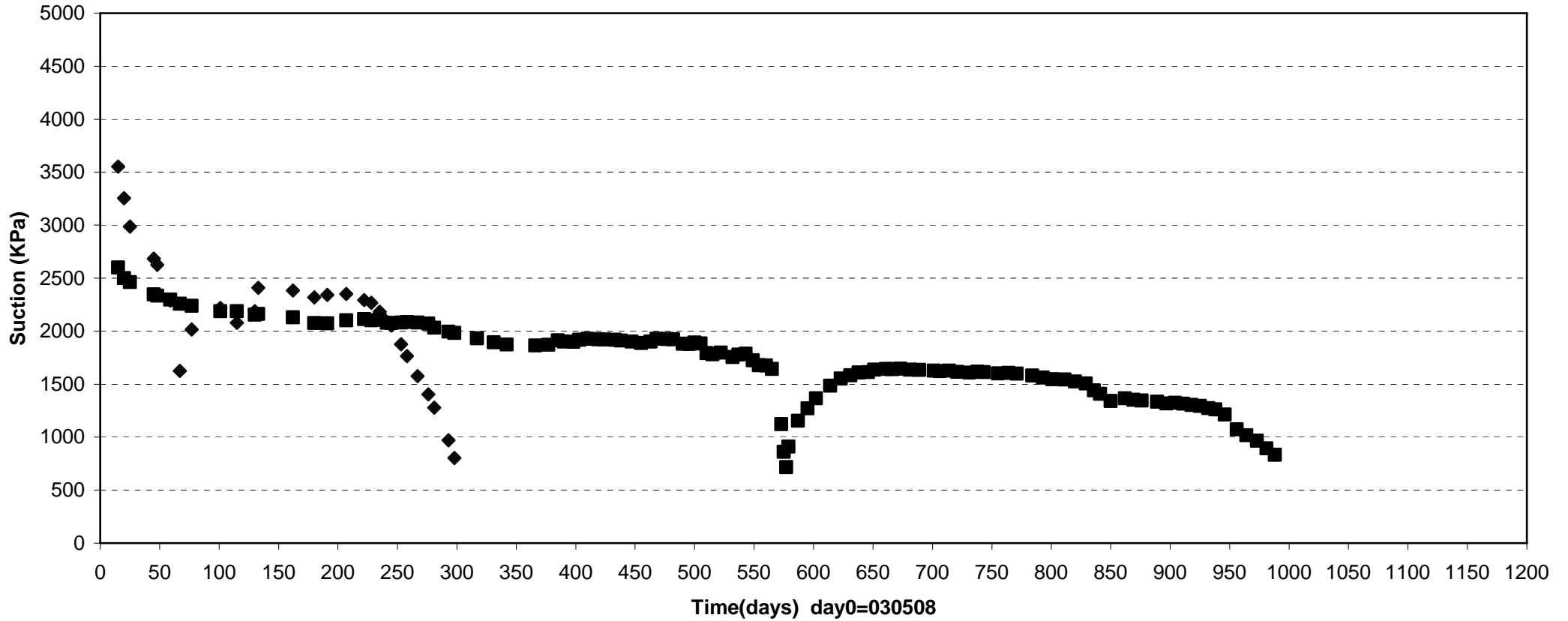
Prototype\ Backfill \ Section 2 (030508-060601)  
 Total pressure - Kulite



□ PFA01 (Inner part\0\0\3556)	■ PFA05 (E5\0\2.3\3551)	◇ PFA06 (E5\2.3\3551)	◆ PFA07 (E5\0\2.3\3551)
△ PFA10 (E6\0\0\3545)	▲ PFA12 (E6\0\2.6\3545)	× PFA16 (In front of plug\0\0\3539)	

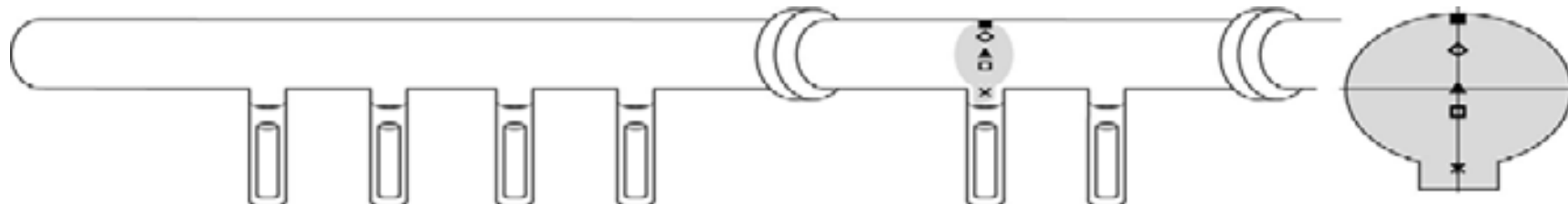
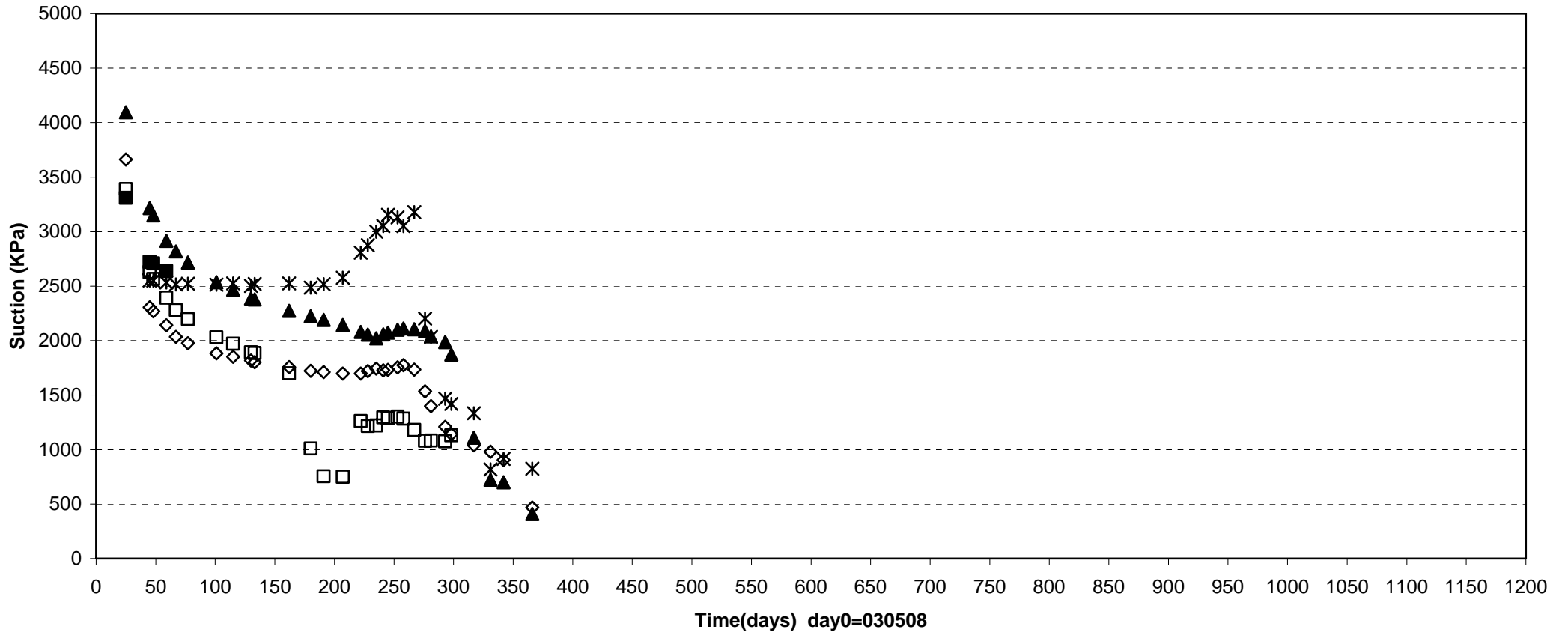


Prototype\Backfill \Section2\ Inner part (030508-060601)  
 Suction - Wescor



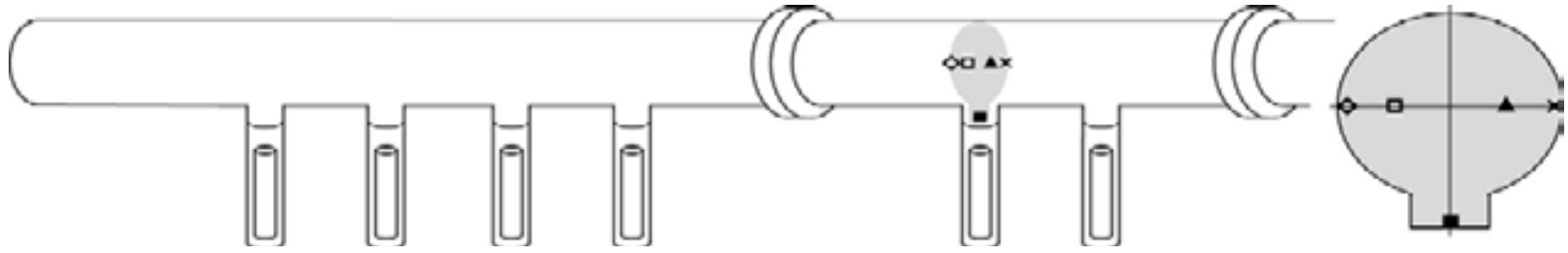
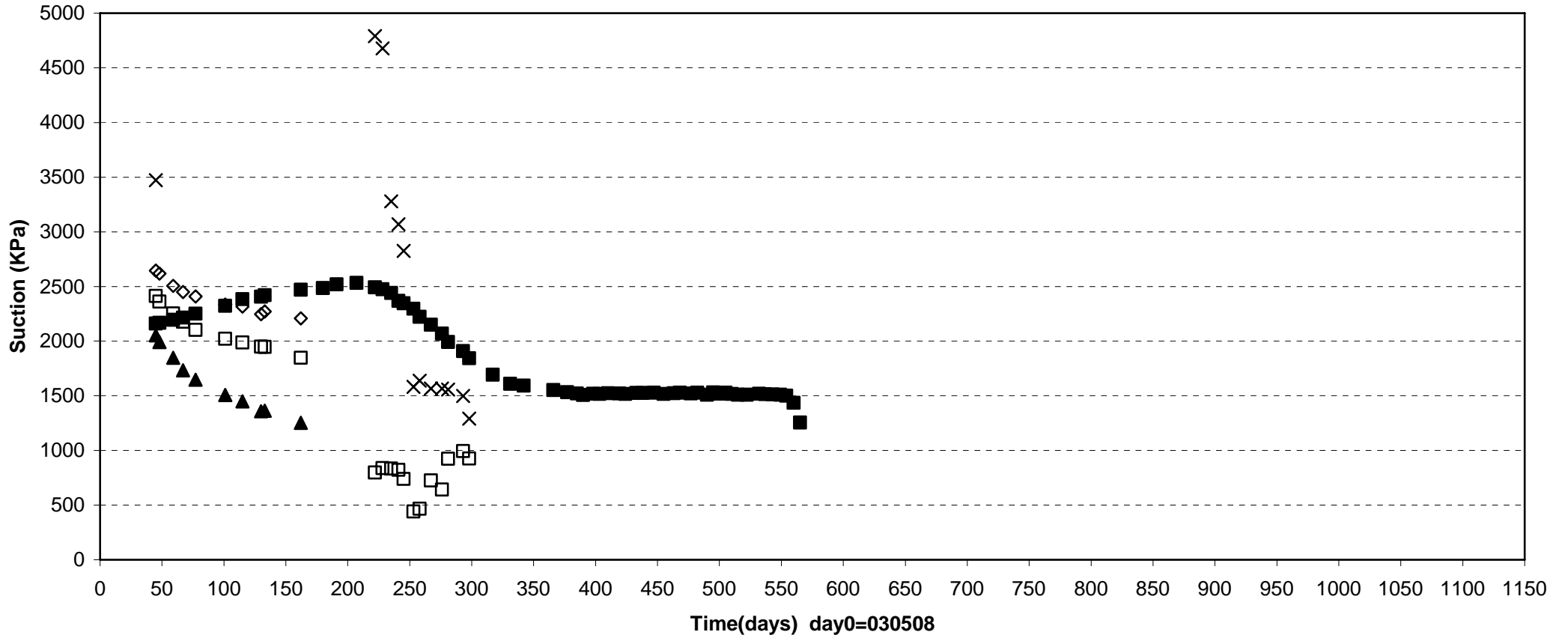
◆ WFA01 (Inner part\0\0\3556) ■ WFA02 (Inner part\0\0\3554)

Prototype\Backfill\ Above dep.hole 5 (030508-060601)  
Suction - Wescor



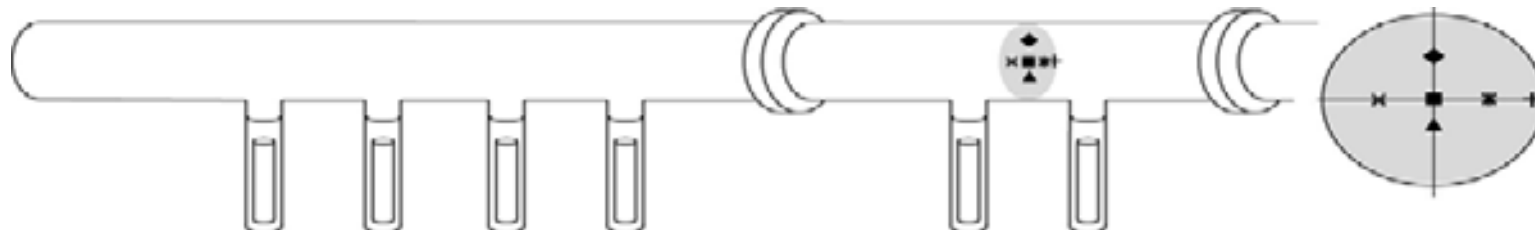
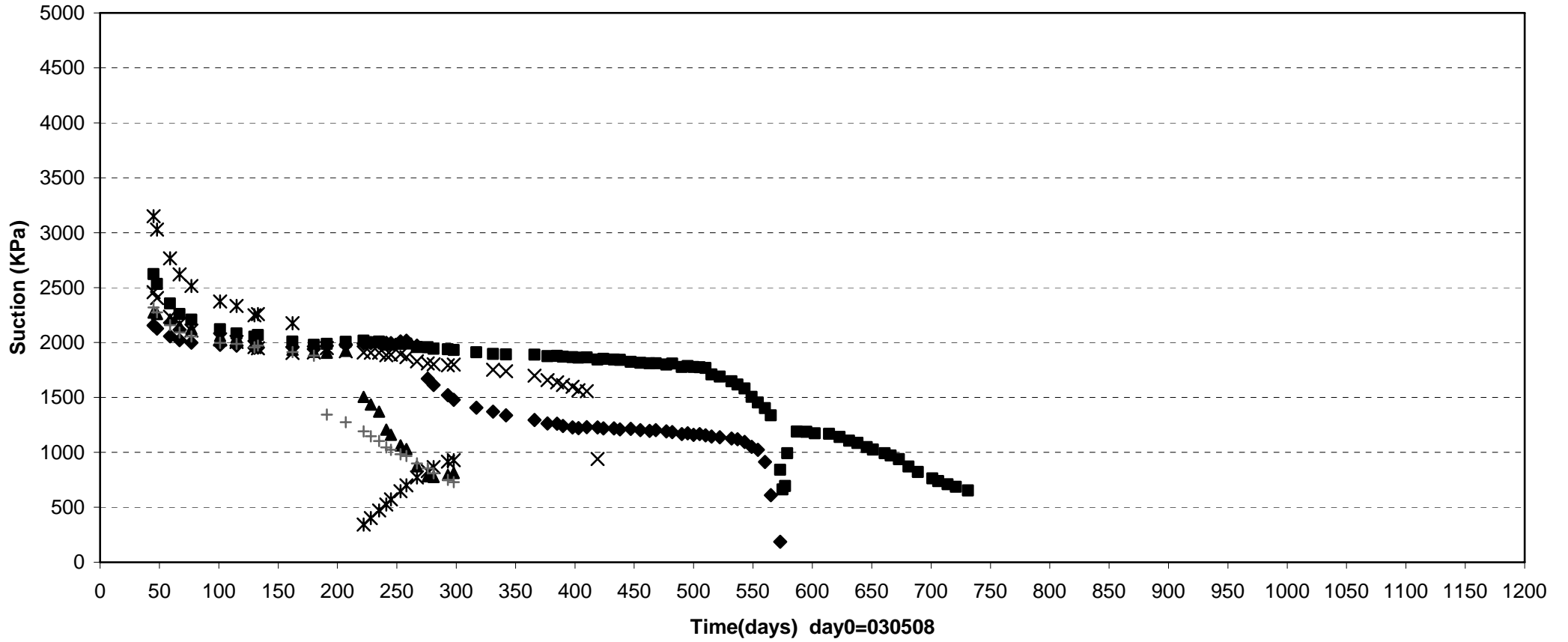
■ WFA03(E5\0\2.3\3551) ◇ WFA04(E5\0\1.25\3551) ▲ WFA05(E5\0\0\3551) □ WFA06(E5\0\0.8\3551) ✱ WFA08(E5\0\2.6\3551)

Prototype\Backfill\ Above dep.hole 5 (030508-060601)  
Suction - Wescor



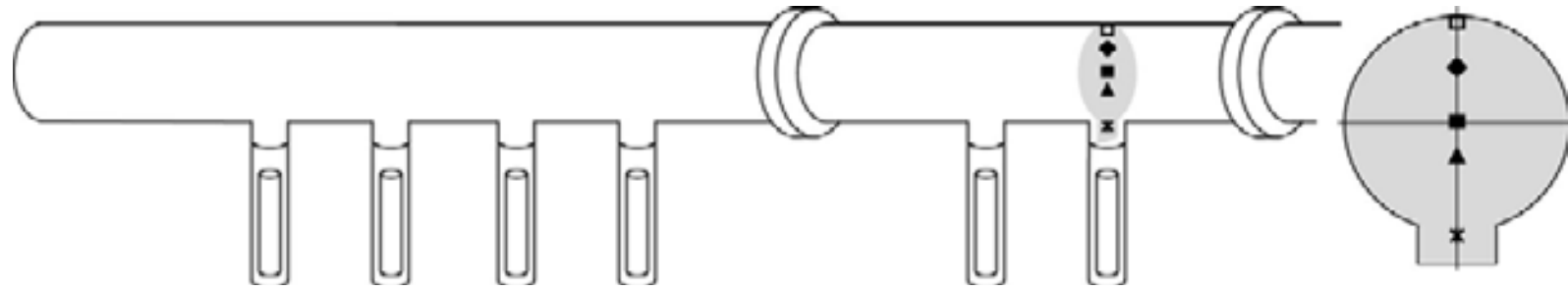
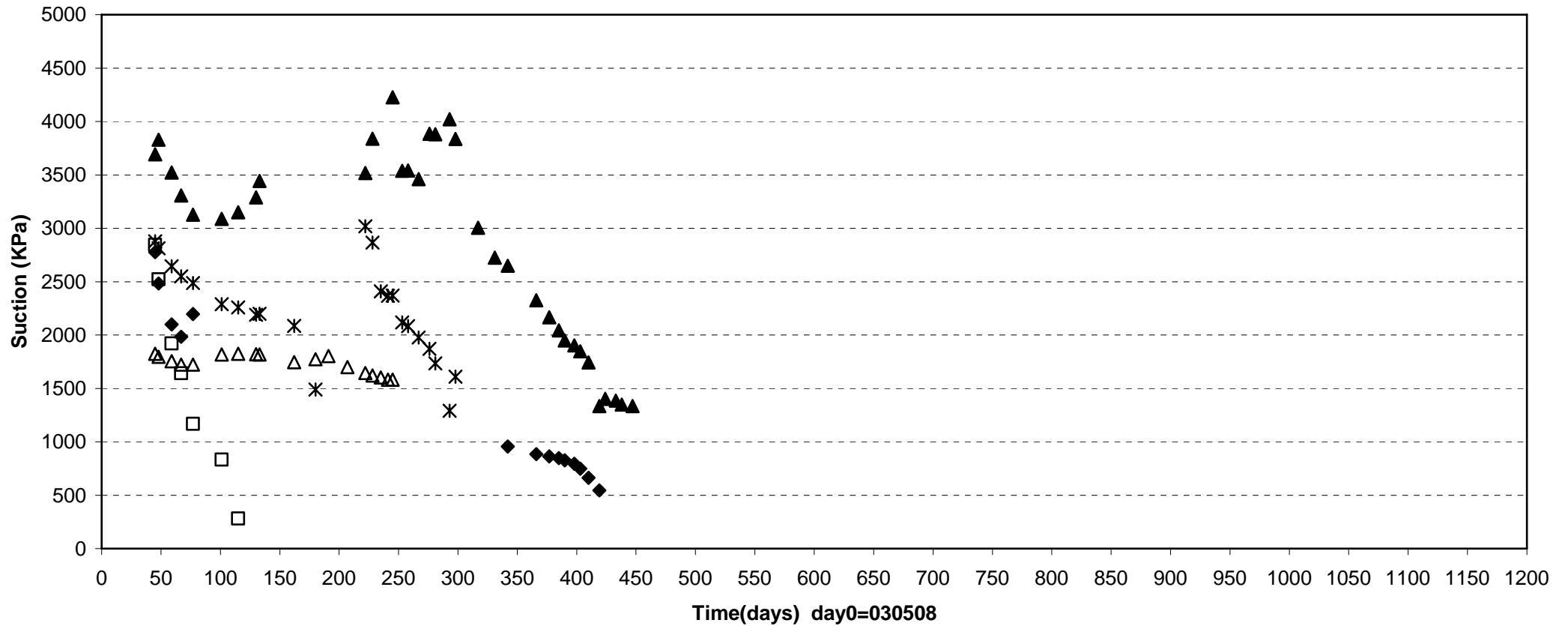
■ WFA09(E5\0\3.15\3551) ◇ WFA10(E5\2.3\0\3551) □ WFA11(E5\1.25\0\3551) ▲ WFA12(E5\1.25\0\3551) × WFA13(E5\2.3\0\3551)

Prototype\Backfill \ Between dep.hole 5 and hole 6 (030508-060601)  
Suction - Wescor



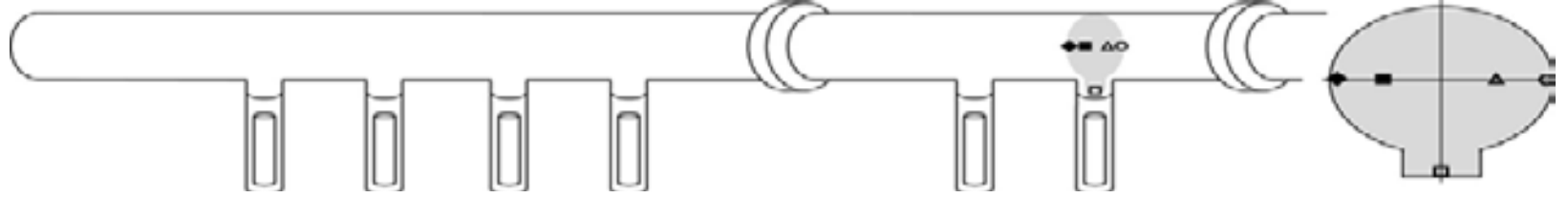
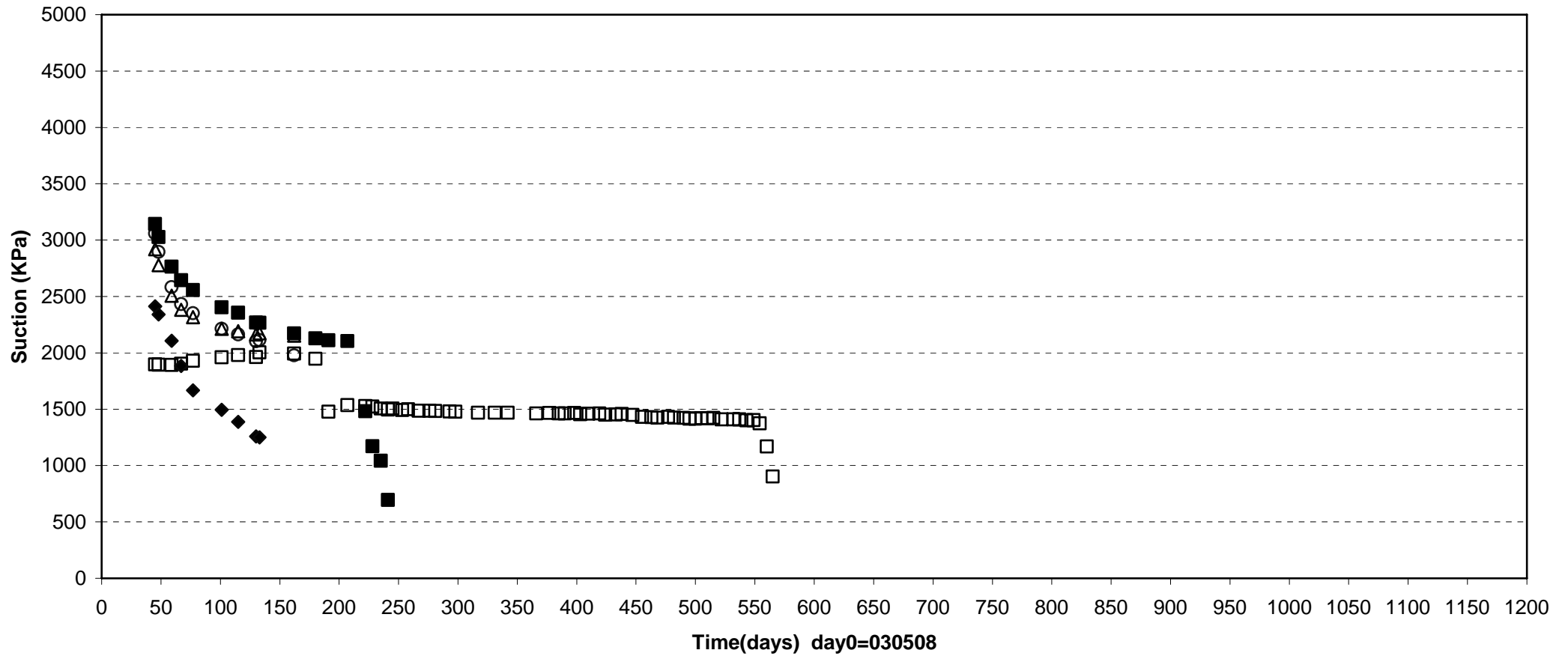
- ◆ WFA15(F5-6\0\1.25\3548)    ■ WFA16(F5-6\0\0\3548)    ▲ WFA17(F5-6\0\0.8\3548)    × WFA18(F5-6\1.25\0\3548)
- ✱ WFA19(F5-6\1.25\0\3548)    + WFA30(E5-6\0\2.3\3548)

Prototype\Backfill \Section2\ Above dep.hole 6 (030508-060601)  
Suction - Wescor



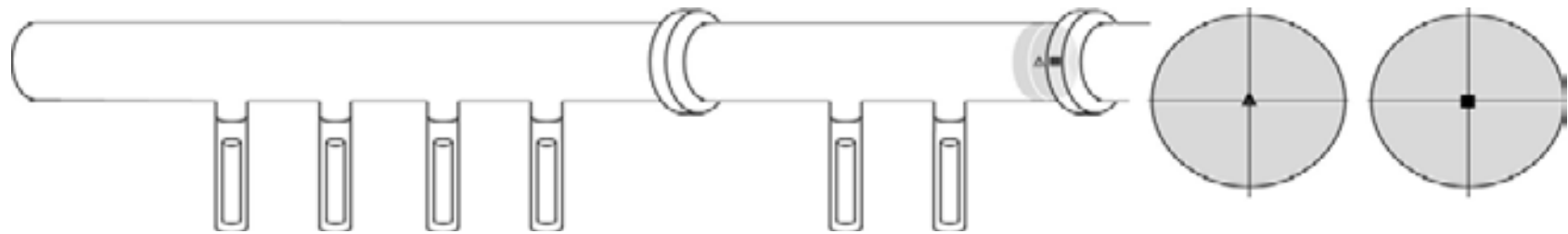
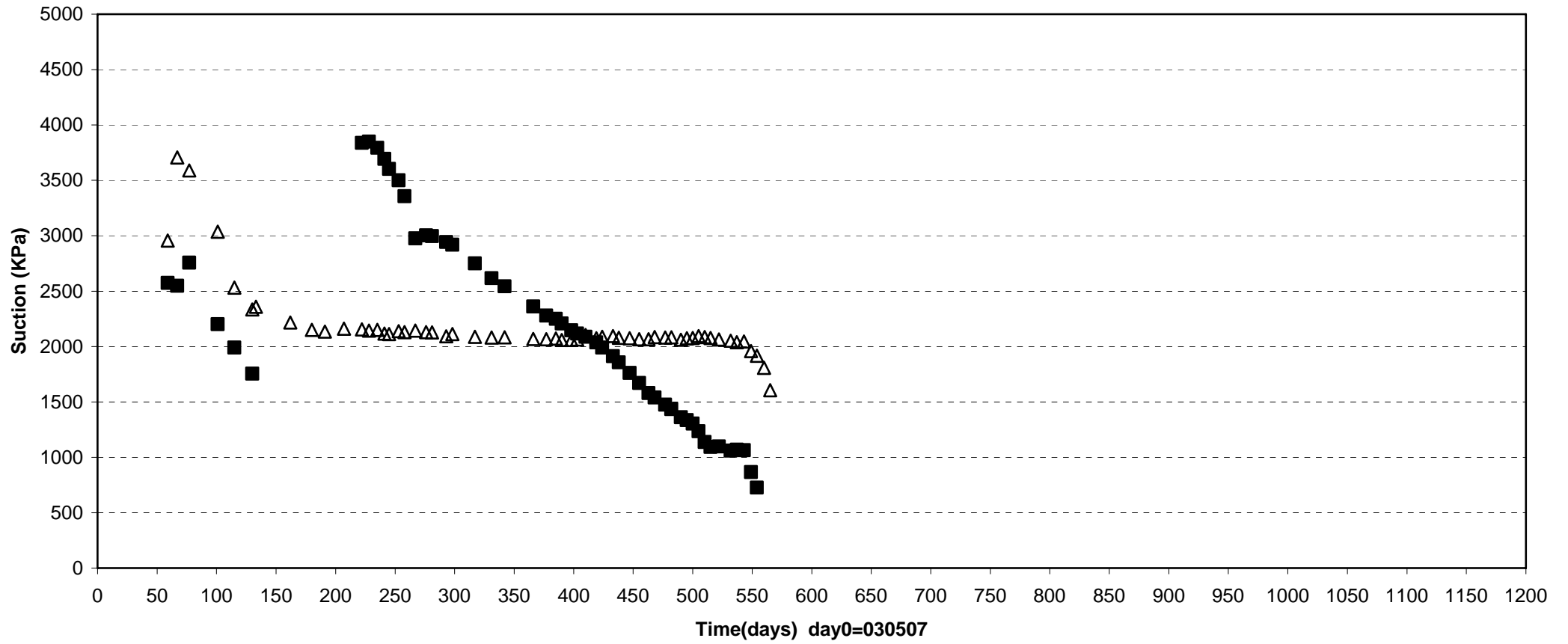
□ WFA20(E6\0\2.3\3545) ◆ WFA21(E6\0\1.25\3545) ■ WFA22(E6\0\0\3545) ▲ WFA23(E6\0\0.8\3545) \* WFA25(E6\0\2.6\3545) △ WFA24(E6\0\1.75\3545)

Prototype\Backfill\Section2\ Above dep.hole 6 (030508-060601)  
Suction - Wescor



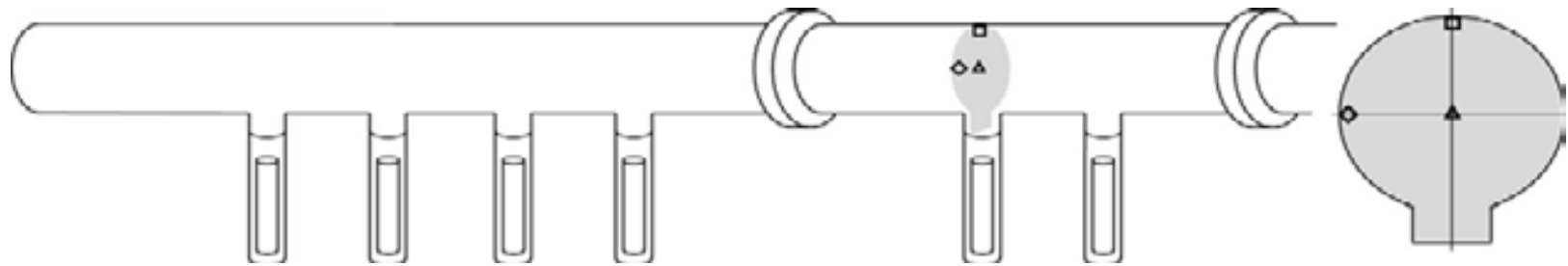
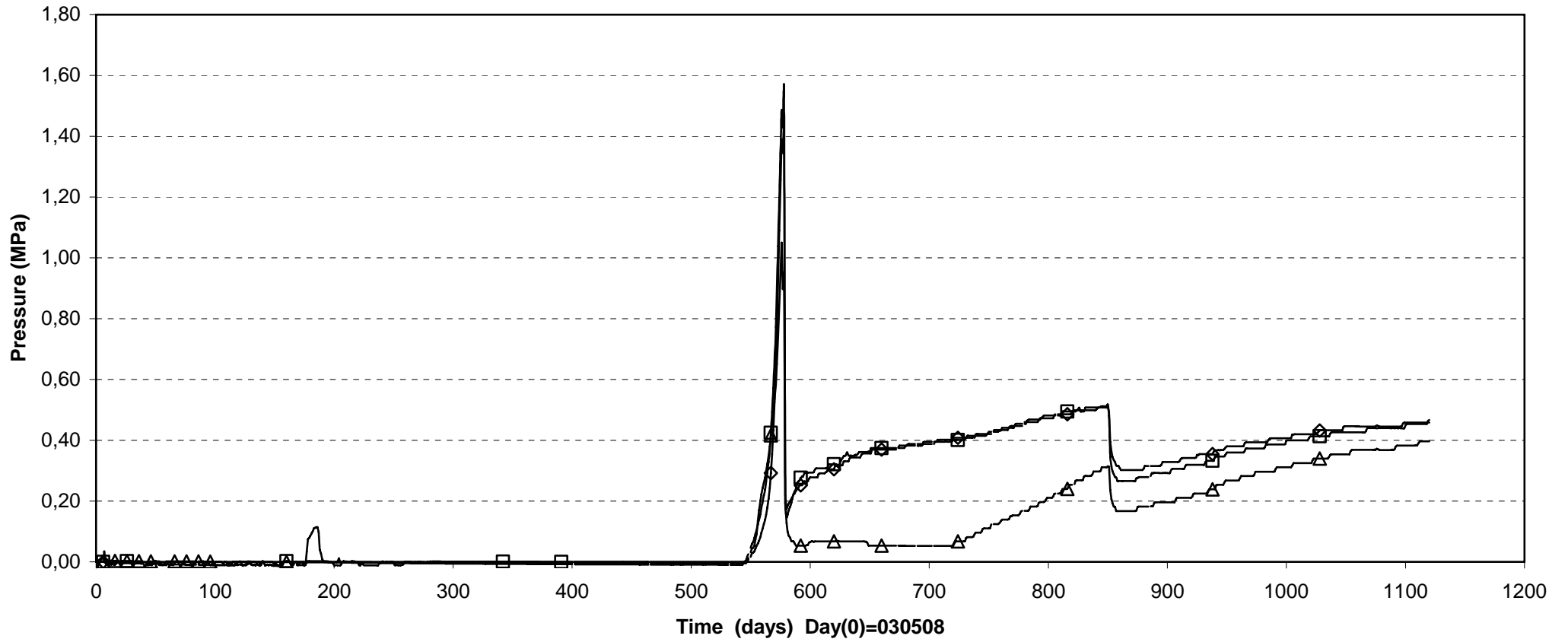
○ WFA07(E6\2.3\0\3545) □ WFA26(E6\0\ -3.15\3545) ◆ WFA27(E6\ -2.3\0\3545) ■ WFA28(E6\ -1.25\0\3545) △ WFA29(E6\1.25\0\3545)

Prototype\Backfill \Section2 \ In front of plug (030508-060601)  
 Suction - Wescor



△ WFA31(In front of plug\0\0\3540) ■ WFA32(In front of plug\0\0\3539)

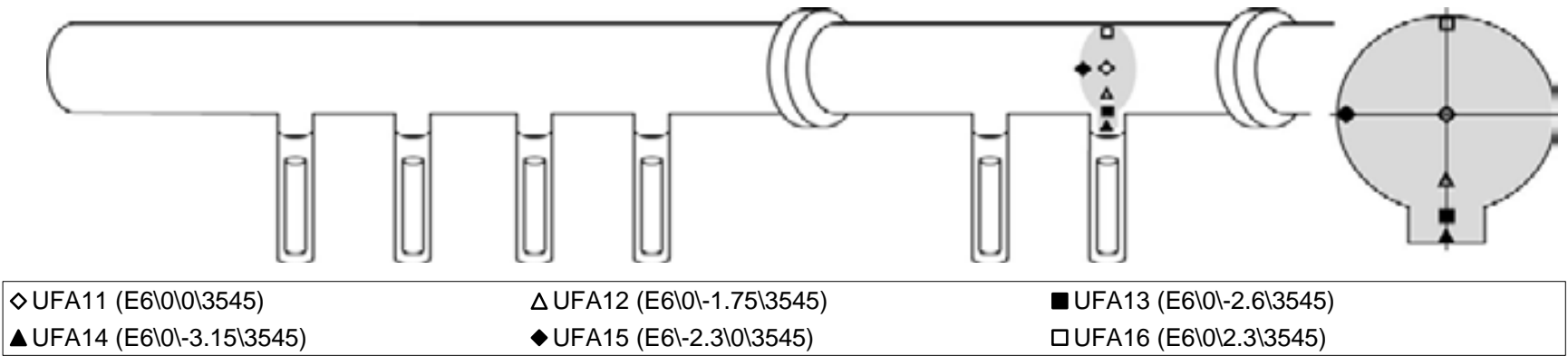
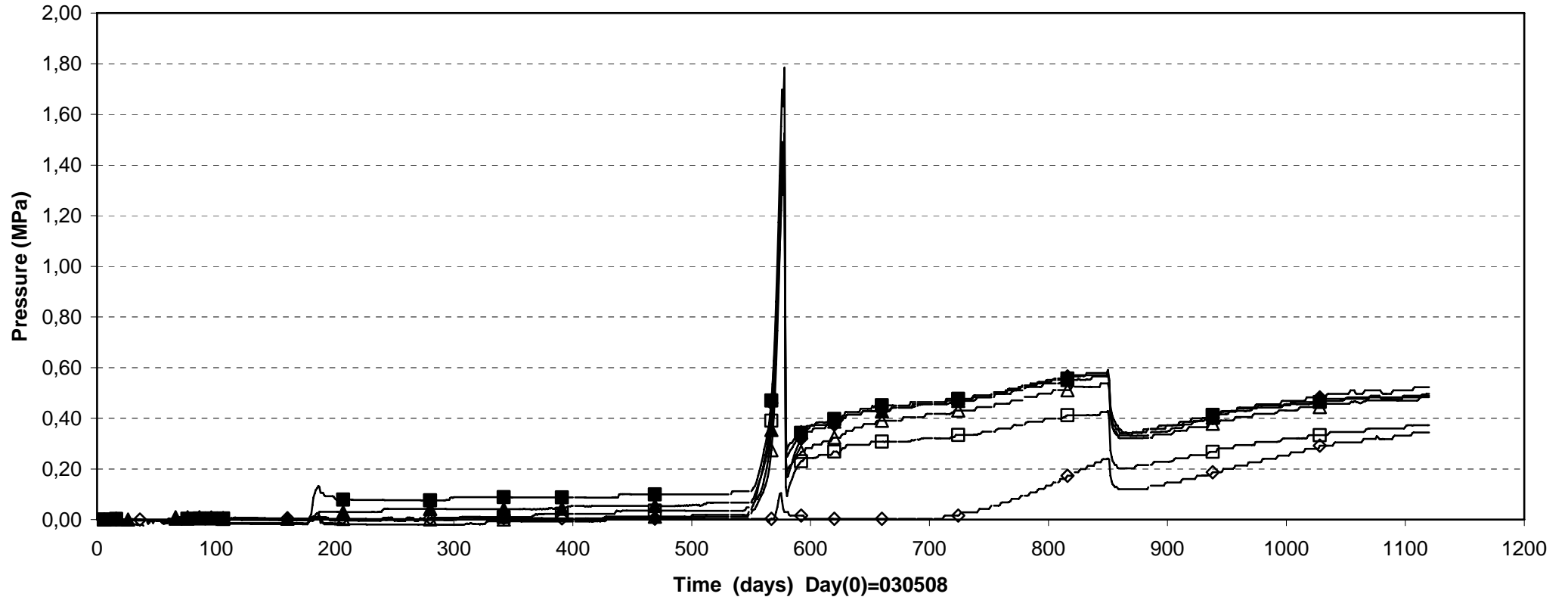
Prototype\Backfill \Over hole 5 (030508-060601)  
Pore pressure - Geokon



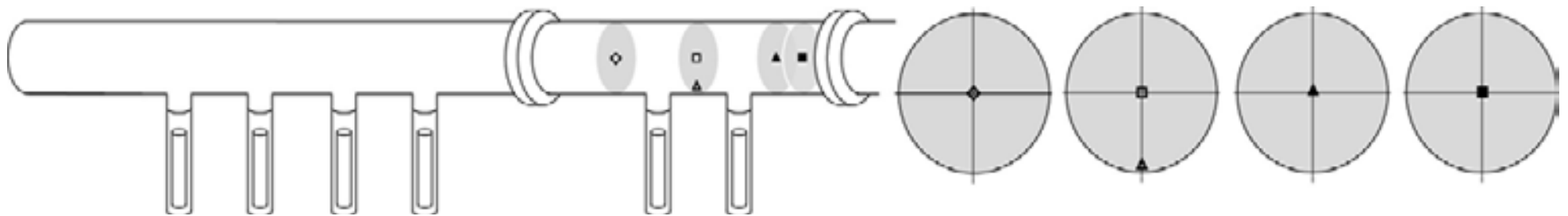
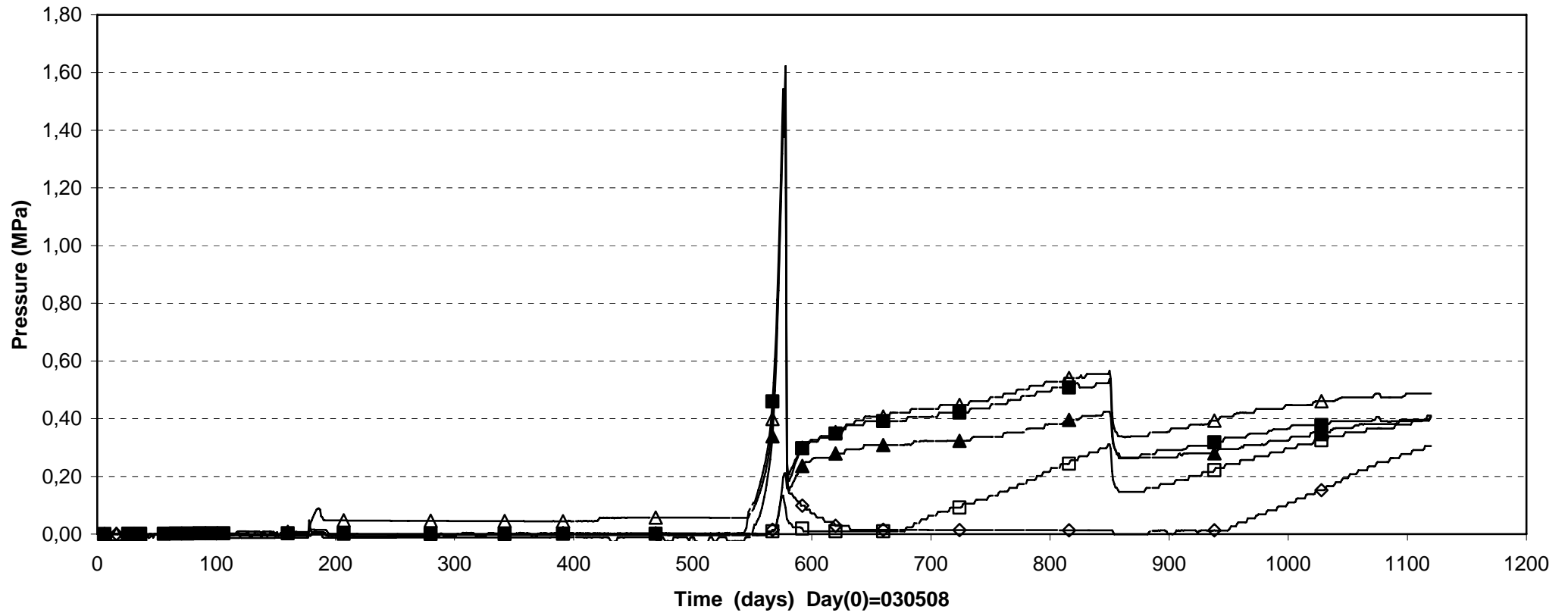
△ UFA03 (E5\0\0\3551)
◇ UFA07 (E5\0\1.75\3551)
□ UFA08 (E5\0\2.3\3551)



**Prototype \Backfill \ Over hole 6 (030508-060601)**  
**Pore pressure - Geokon**

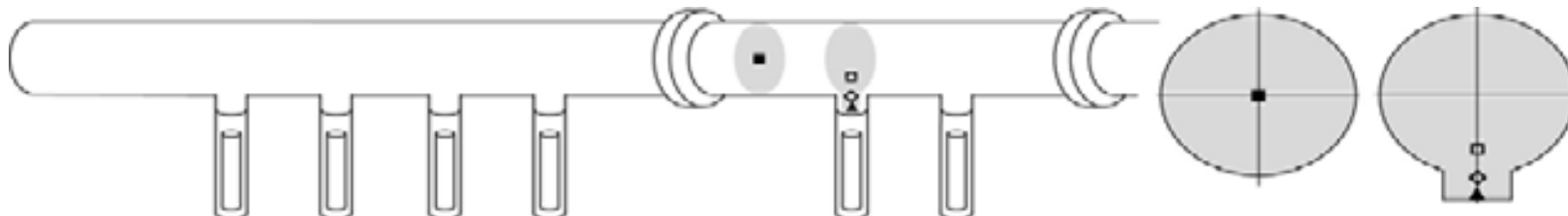
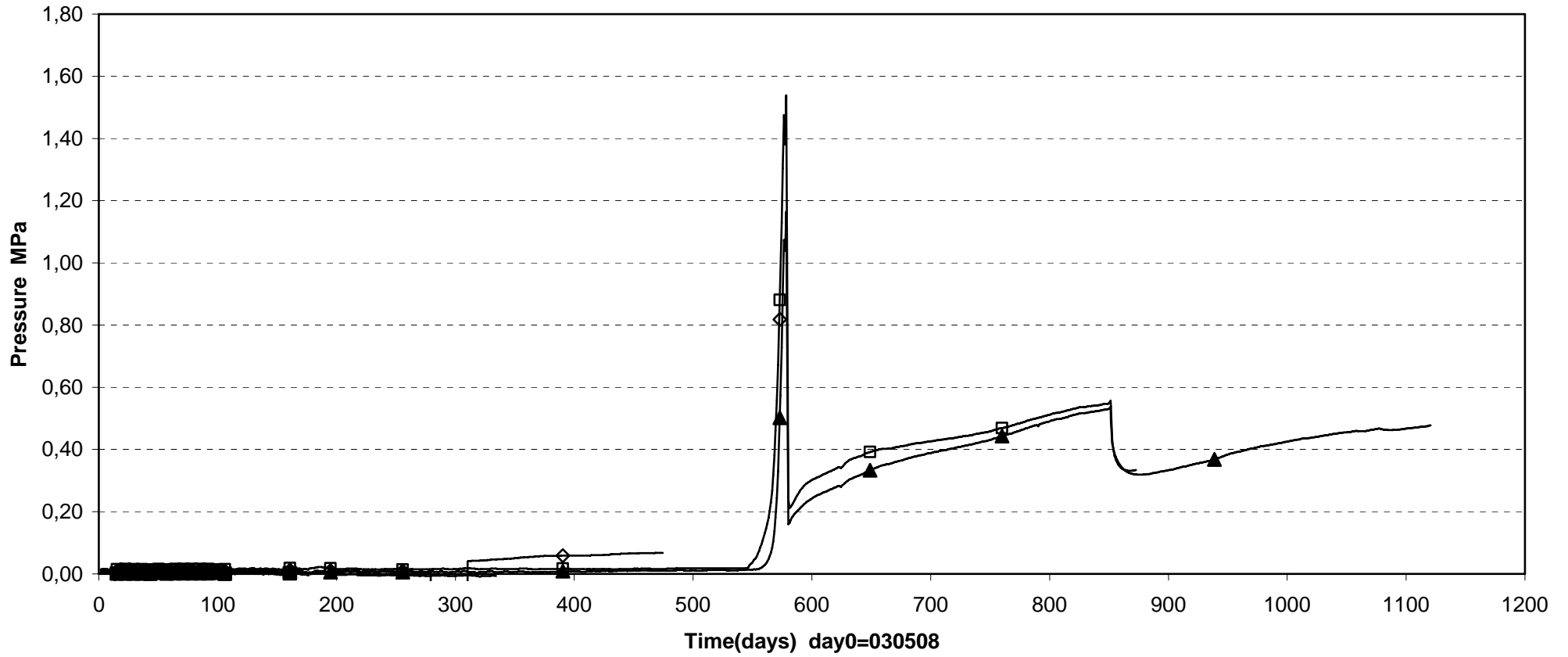


Prototype\Backfill \ Section2 (030508-060601)  
 Pore pressure - Geokon



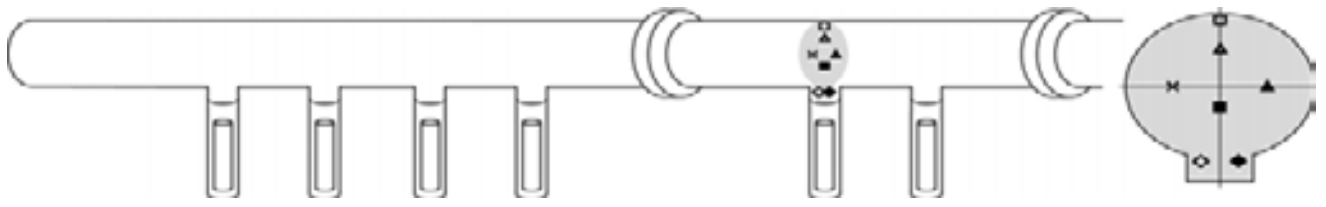
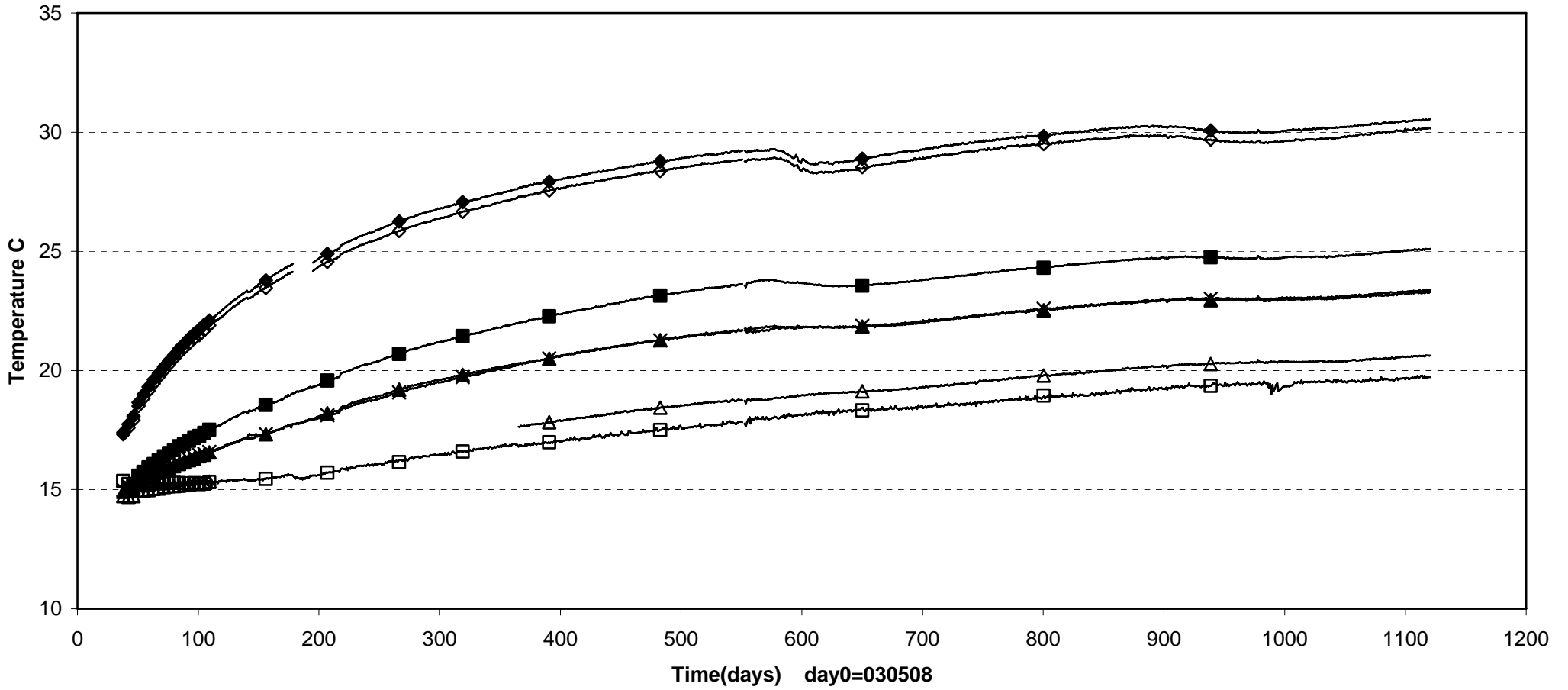
- |                                 |                                     |                             |
|---------------------------------|-------------------------------------|-----------------------------|
| ◇ UFA02 (Inner part\0\0\3554.1) | □ UFA09 (F5-6\0\0\3548)             | △ UFA10 (F5-6\0\0-2.0\3548) |
| ▲ UFA17(E5\2.3\0\3551)          | ■ UFA18 (In front of plug\0\0\3539) |                             |

Prototype\ Backfill \ Section 2 (030508-060601)  
Pore pressure - Kulite



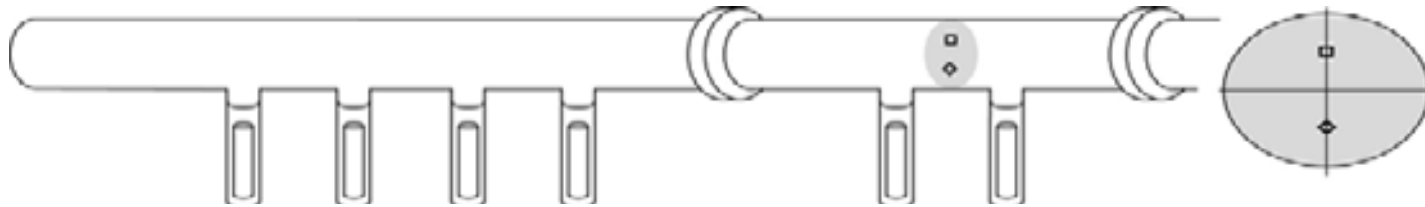
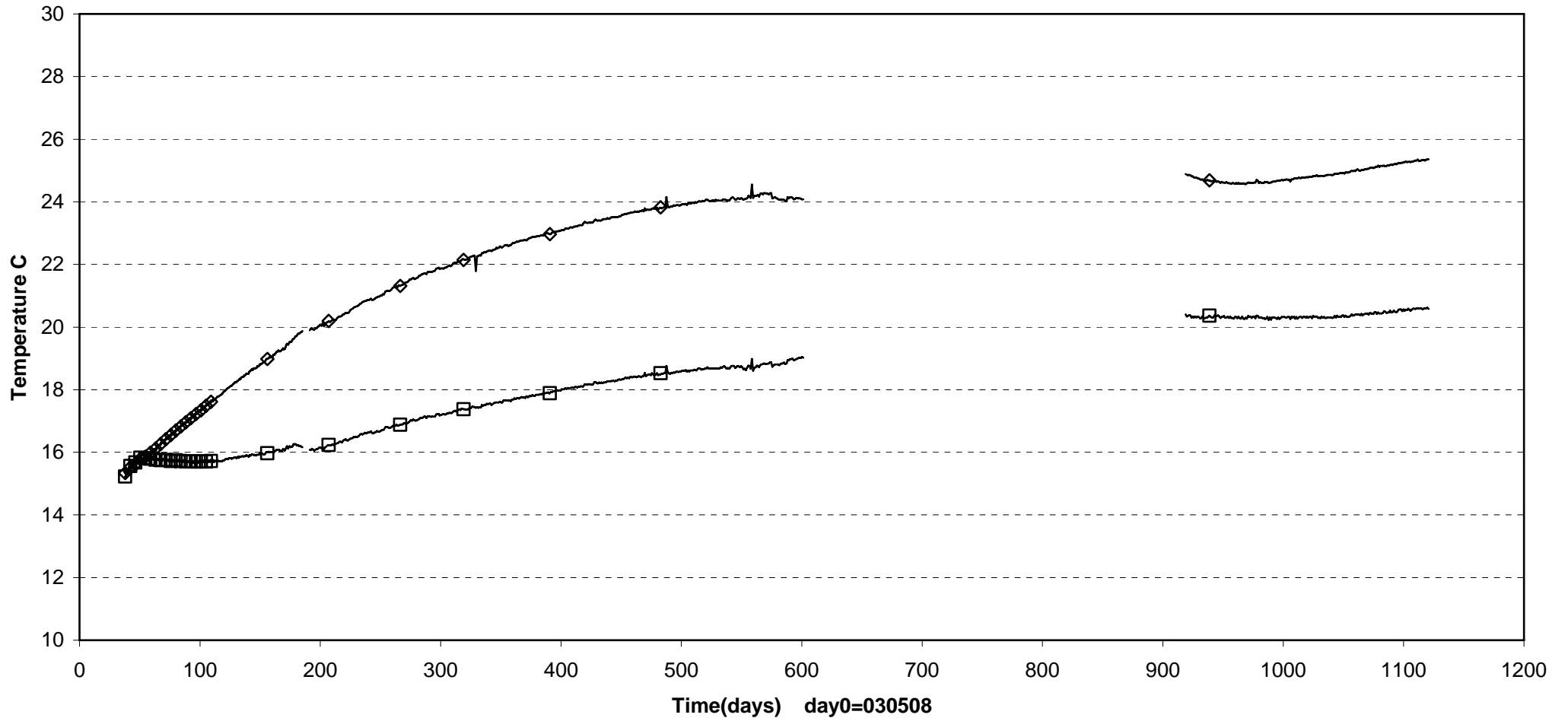
■ UFA01 (Inner part\0\0\3556) □ UFA04 (E5\0\ -1.75\3551) ◇ UFA05 (E5\0\ -2.6\3551) ▲ UFA06 (E5\0\ -3.15\3551)

Prototype\ Backfill \ Above dep.hole5 (030508-060601)  
 Temperature - Pentronic



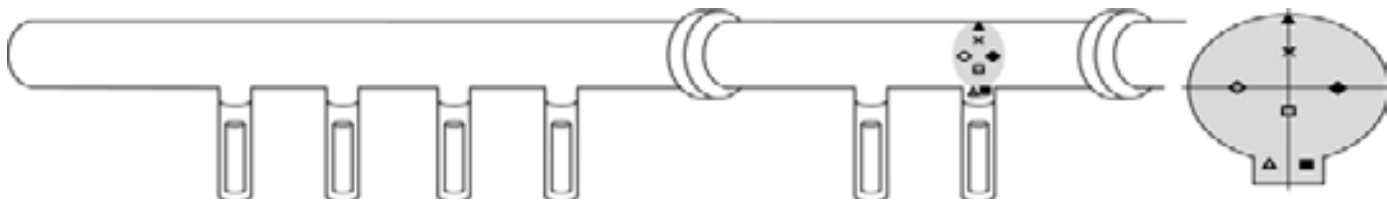
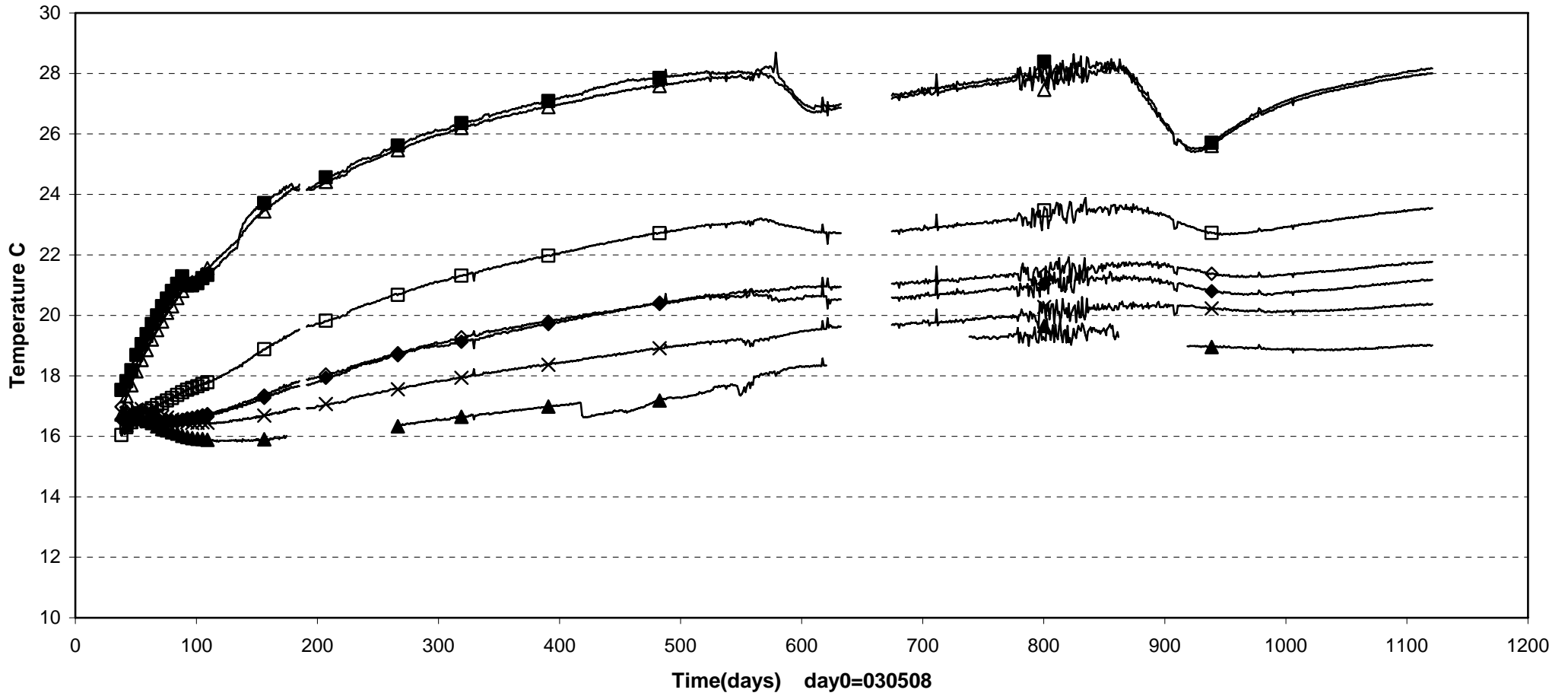
- TFA01(E5\0.2.3\3551)      △ TFA02(E5\0\1.25\3551)      ■ TFA03(E5\0\-.8\3551)      ◇ TFA04(E5\-.0.5\-.2.6\3551)
- ◆ TFA05(E5\0.5\-.2.6\3551)      × TFA06(E5\-.1.25\0\3551)      ▲ TFA07(E5\1.25\0\3551)

Prototype\ Backfill \ Between dep.hole 5-6 (030508-060601)  
 Temperature - Pentronic



□ TFA08(F5-6\0\1.25\3548) ◇ TFA09(F5-6\0\1.25\3548)

Prototype\ Backfill \ Above dep.hole6 (030508-060601)  
 Temperature - Pentronic



- |                          |                         |                         |                          |
|--------------------------|-------------------------|-------------------------|--------------------------|
| ▲ TFA10(E6\0.2.3\3545)   | × TFA11(E6\0.1.25\3545) | □ TFA12(E6\0-0.8\3545)  | △ TFA13(E6\0.5\2.6\3545) |
| ■ TFA14(E6\0.5\2.6\3545) | ◇ TFA15(E6\1.25\0\3545) | ◆ TFA16(E6\1.25\0\3545) |                          |

## **Appendix 8**

### **Canister displacements**

Barcena, I. and P.A. Fernández, AITEMIN







**PROTOTYPE REPOSITORY IN  
OPERATION**

**CANISTER DISPLACEMENT  
TRACKING**

I. Bárcena

June 2006



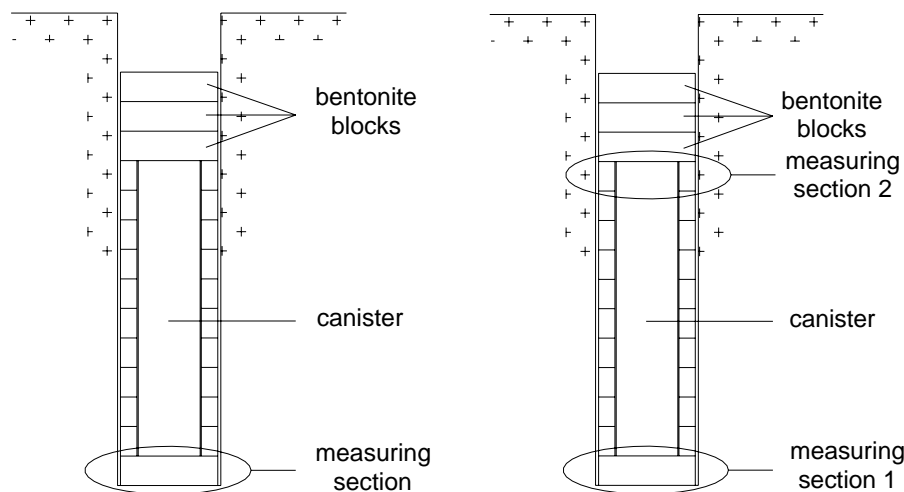
# Contents

<b>1</b>	<b>Layout</b>	<b>283</b>
<b>2</b>	<b>General comments</b>	<b>285</b>
<b>3</b>	<b>Deposition hole 3</b>	<b>287</b>
3.1	Vertical sensors	287
3.2	Horizontal sensors	287
<b>4</b>	<b>Deposition hole 6</b>	<b>289</b>
4.1	Vertical sensors	289
4.2	Horizontal sensors	289
<b>5</b>	<b>DATA PLOT deposition hole 3</b>	<b>291</b>
<b>6</b>	<b>DATA PLOT deposition hole 6</b>	<b>292</b>
<b>7</b>	<b>MONITORING SCREENS</b>	<b>293</b>



# 1 Layout

The measurement of displacements is carried out in Section 1 on the canister in deposition hole 3. In Section 2 the displacements are measured on the canister in deposition hole 6. In deposition hole 3 six sensors are grouped into one measuring section, while in deposition hole 6 there are two measuring sections, at the bottom and on top of the canister, as shown in Figure 1.

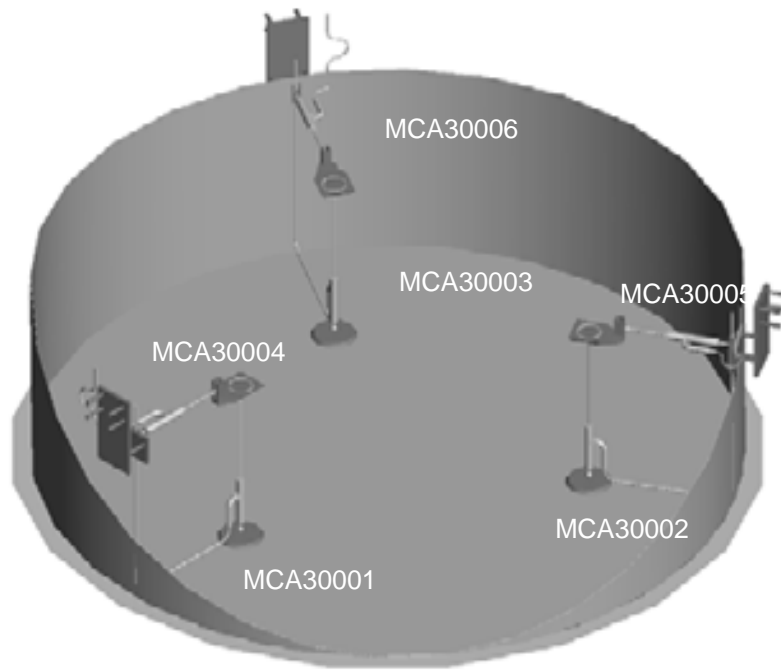


**Figure 1.** Location of measuring sections for deposition hole 3 (left) and deposition hole 6 (right)

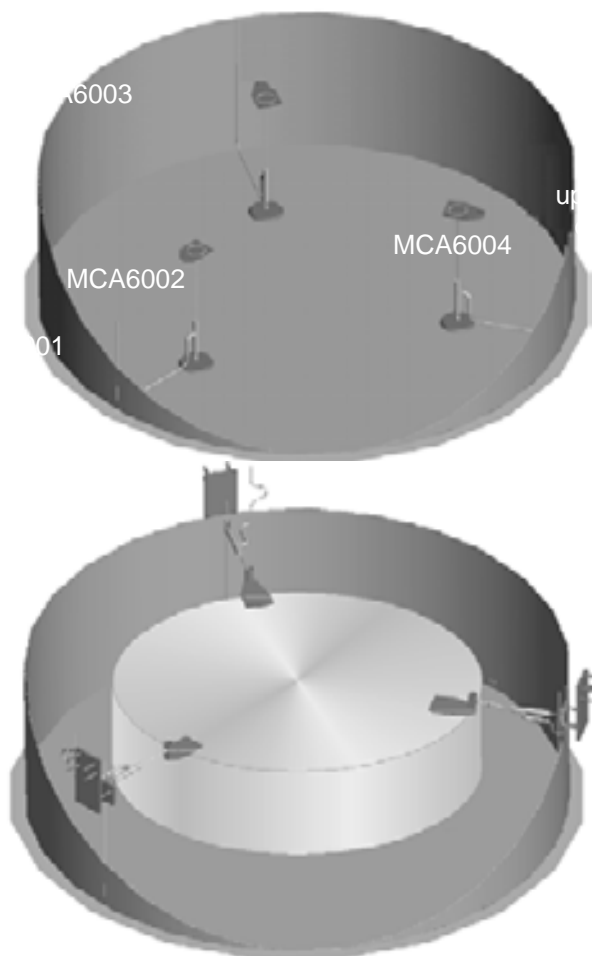
For deposition hole No. 3 three sensors, named MCA30001 to MCA30003, have been placed in vertical position into holes drilled into the bottom bentonite block. These three sensors determine the vertical displacement of the canister, as well as any possible tilt. The points where the sensors are attached to the canister are the same as for the horizontal sensors.

The other three displacement sensors for deposition hole 3, named MCA30004 to MCA30006, are placed horizontally at the top of the lower bentonite block, close to the lower lid of the canister and attached to it, in a 120° radial disposition. Thus, the sensors will be always in a horizontal position, so that the horizontal displacement of the canister can be measured. The sensors have been placed so as to avoid interfering with other sensors installed in the block. Figure 2 illustrates the position of the six sensors.

For deposition hole 6 three sensors, named MC6001 to MC6003, have been placed in vertical position in the same way as for deposition hole 3. The horizontal sensors, named MCA6004 to MCA6006, have been placed in the same position as in deposition hole 3, but in the tenth bentonite ring, attached to the upper lid of the canister. Figure 3 shows the position of the sensors in this deposition hole.



**Figure 2.** General view of sensors in deposition hole 3



**Figure 3.** General view of vertical (left) and horizontal (right) sensors in deposition hole 6

## 2 General comments

This is the sixth “Prototype Repository in Operation” report issued for SKB, and the third semestral one.

Monitoring is carried out since 010623 in deposition hole 3 and since 030429 in deposition hole 6. Day 0 corresponds to 010917 for deposition hole 3 and to 030508 for deposition hole 6. Negative values correspond to a retraction of the transducer, which means vertical sinking or horizontal approaching to the rock surface, depending on the transducer position.

It can be clearly noticed in both holes the moment when the protection plastic sheet was removed, right before the backfilling of the tunnel. At that point, the sensors started registering displacements due to the bentonite swelling.

According to the measures carried out prior to the buffer installation, the water inflow in deposition hole 6 is two times that of deposition hole 3. This could be somewhat noticed when comparing the results from both holes, as the registered displacements in deposition hole 6 are much bigger in one year than those of deposition hole 3 in three years.

The tunnel drainage was closed on 041101 and re-opened on day 041206. There was a power cut in all the canisters from 041202 to 041215.

In deposition hole 3, the closure and subsequent re-opening of the tunnel drainage seem to have had a high influence. In comparison, the power cut had little effect in general in this hole.

On the contrary, no significant effect from the drainage closure and re-opening can be noticed in deposition hole 6, where the effects from the power cut can be more clearly seen.

A major problem was detected in the computer of the Data Acquisition System in September 2005. As a consequence, no data could be registered from 050925 to 060207, when the computer was checked “in situ” and put again in operation. On 060408 the computer failed again, so no data was registered from that date until the end of the reported period. The problem has been fixed in June 2006 by replacing the full hard drive of the computer.

Two sensors out of the 12 installed have failed permanently during the monitoring phase. These are MCA30002, one of the vertical sensors in deposition hole 3, which failed on day 117 (020112), and horizontal sensor MCA6006 in deposition hole 6, which failed during the data blackout from day 872 (050926) to day 1006 (060207). Vertical sensor MCA6002 failed on day 721 (050428) and recovered on day 756 (050602), but lately, during certain periods registered oscillating values (not shown in the data plots), so some doubts remain about its reliability.

The results obtained in both deposition holes are described hereafter. Monitoring screens correspond to data of 060407.





## **3 Deposition hole 3**

### **3.1 Vertical sensors**

Two vertical sensors are still in operation in this deposition hole. After an initial small rise of about 0.5 mm, the sensors showed a fast canister sinking that reached about 2 mm below the initial level, when, most likely due to the re-equilibration of pressures below and above the canister, the decrease ceased and the canister started to rise again.

Lately, the rising trend has changed to a sinking in one of the vertical sensors, while in the other one a rising is still registered. This could indicate that a small canister tilting is taking place, although the third value for defining the plane of the canister base is unavailable, and no clear signs of tilting can be noticed in the corresponding horizontal sensors.

### **3.2 Horizontal sensors**

At the start of the monitoring phase, two of the horizontal sensors registered an initial small retraction, while the third one registered a similar elongation, all in the order of half of millimetre. This could indicate a horizontal displacement of the canister. Afterwards, the two sensors showing retraction changed to elongations of about 0.5 mm and 1.5 mm. One of the changes was very fast. No changes were registered in the third sensor, so it is not clear that this is due to a horizontal displacement of the canister. A possible explanation for this behaviour is that it is due to the vertical movement of the canister, although in principle the anchoring points of the horizontal sensors were conceived not to be affected by vertical displacements of the canister.

No changes were registered afterwards until day 1167 (041127), when one of the horizontal sensors showed a fast elongation, followed by a retraction. This behaviour could reflect again the vertical displacement of the canister detected in the same dates, given that the shape of the plot matched exactly the vertical movement and that the other two horizontal sensors did not show any displacement.

Lately, one of the sensors shows a very slight retraction, but some more data are still necessary to make a reliable interpretation.



## **4 Deposition hole 6**

### **4.1 Vertical sensors**

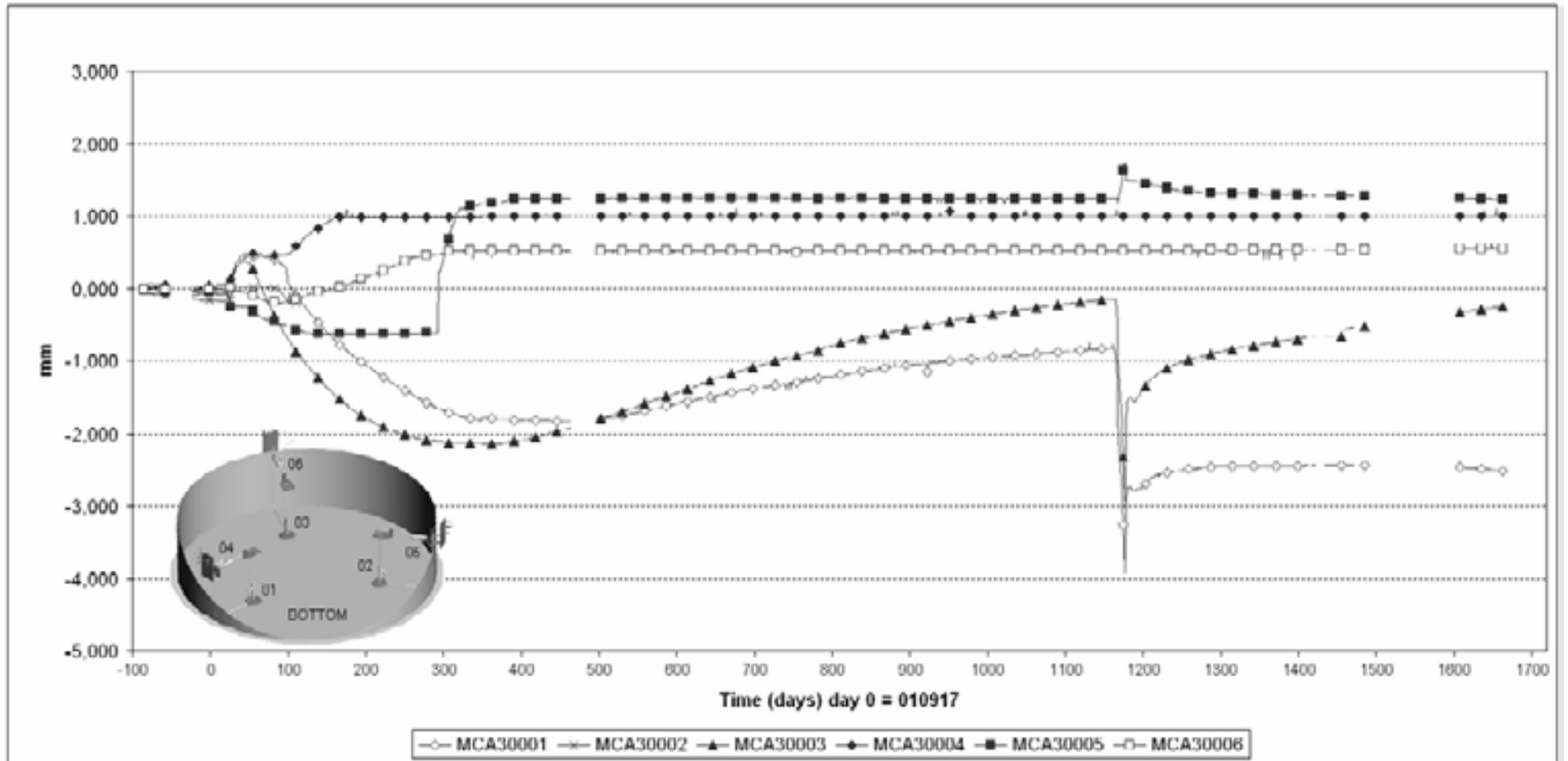
The vertical sensors maintain their trends from the start of the monitoring phase, showing a constant rise of the canister. Although one of the sensors started increasing later than the other two, all the three have been in similar values, what indicates that no tilting of the canister is taking place. The rising rate had slowed down by the end of 2005, but lately the canister rise is clear again, with values around 11 mm in the two reliable sensors.

### **4.2 Horizontal sensors**

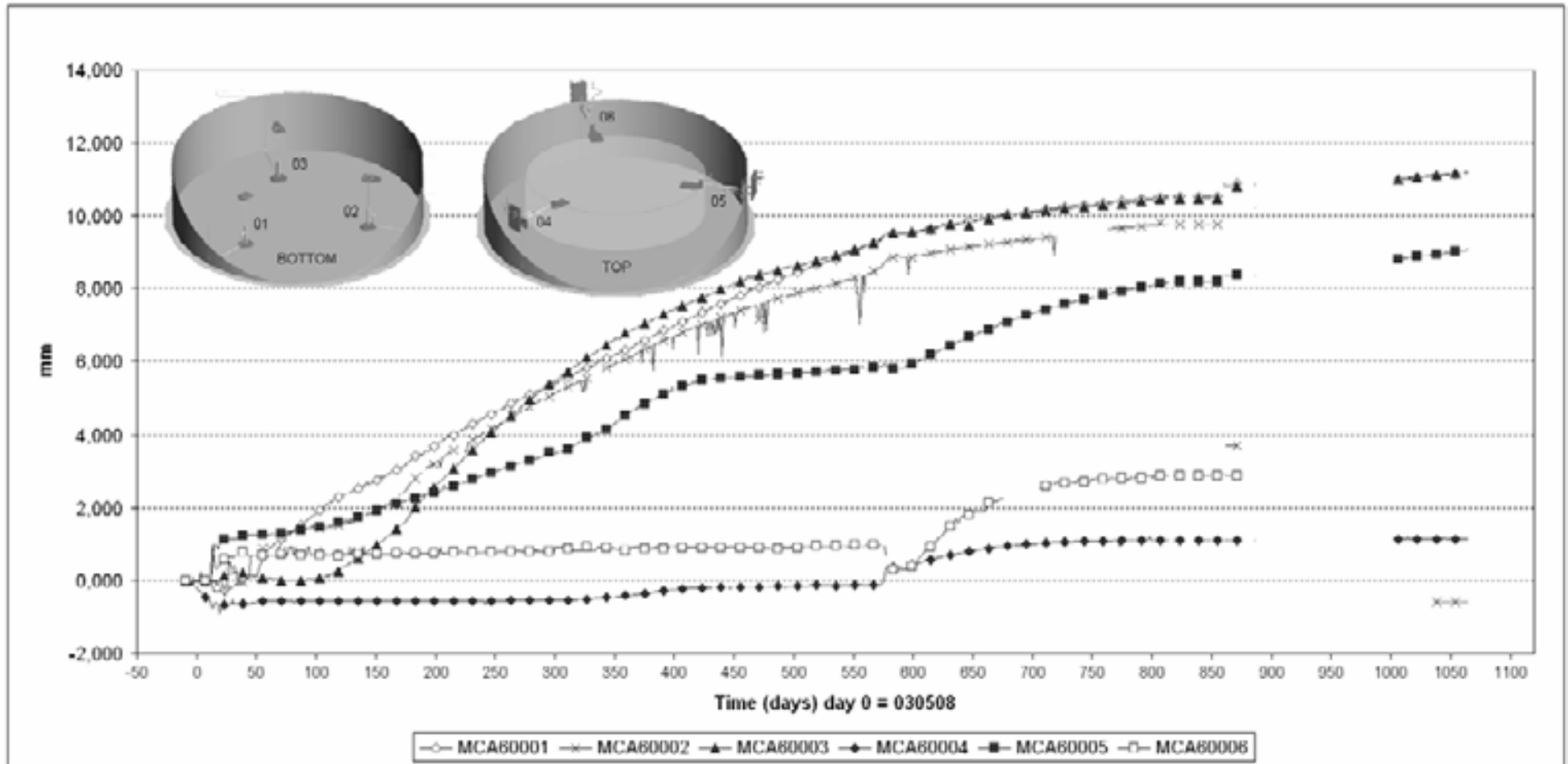
The horizontal sensors showed some fast initial movement at first, with elongation of two sensors and retraction of the third one, what could indicate a canister movement towards this one in the order of 1 mm. Afterwards, one of the elongated sensors, MCA6005, started increasing at a rate similar to the vertical sensors, reaching about 9 mm and still increasing, most likely due to the vertical movement of the canister. The other two sensors have remained more or less constant except for an elongation of between 1 mm and 2 mm occurred during a few months from about day 600 (041228), following the closure and re-opening of the tunnel drainage.



## 5 DATA PLOT deposition hole 3



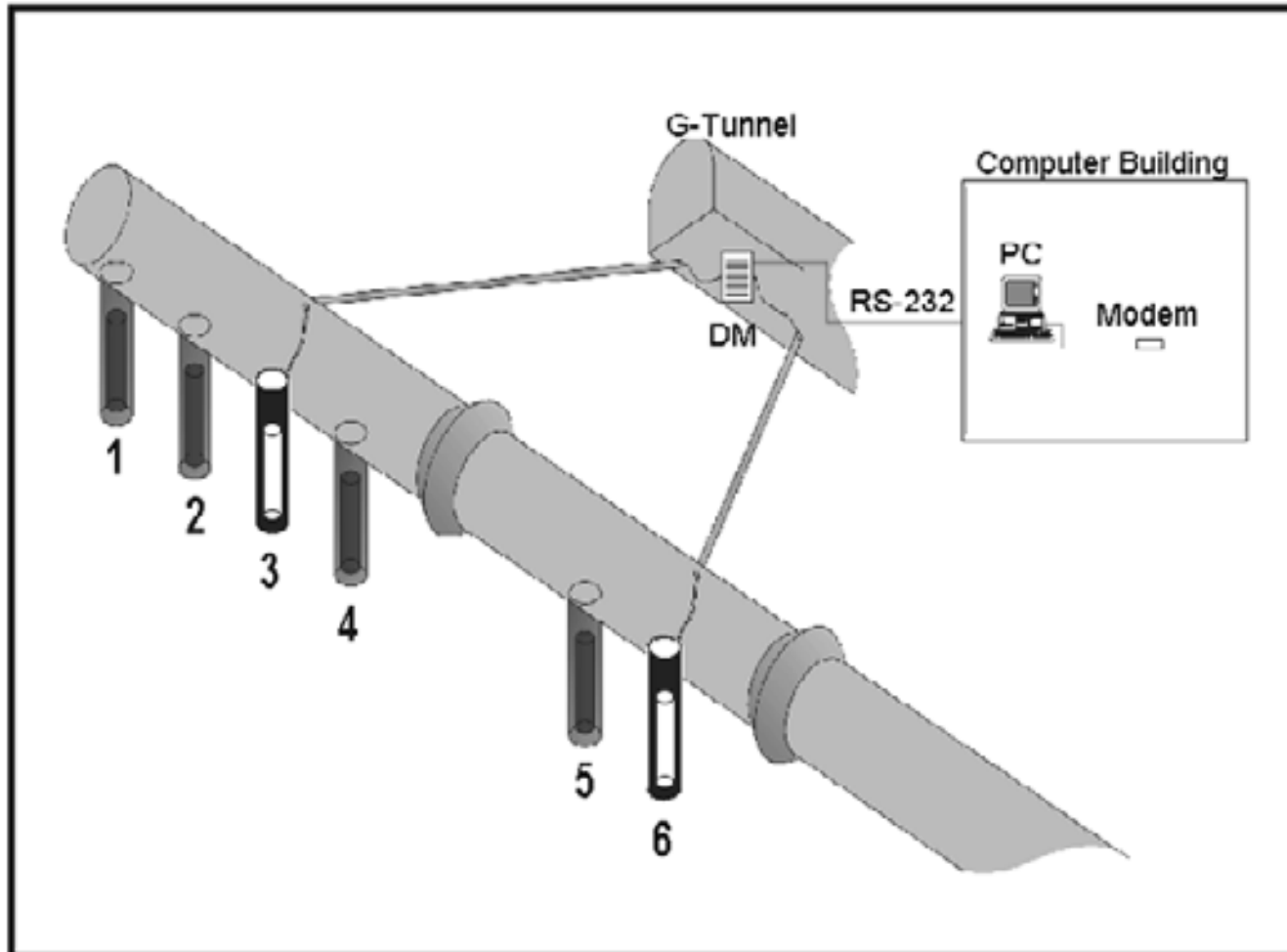
## 6 DATA PLOT deposition hole 6



## 7 MONITORING SCREENS



# PROTOTYPE REPOSITORY



Signal

Displacement

Rel. Displ.

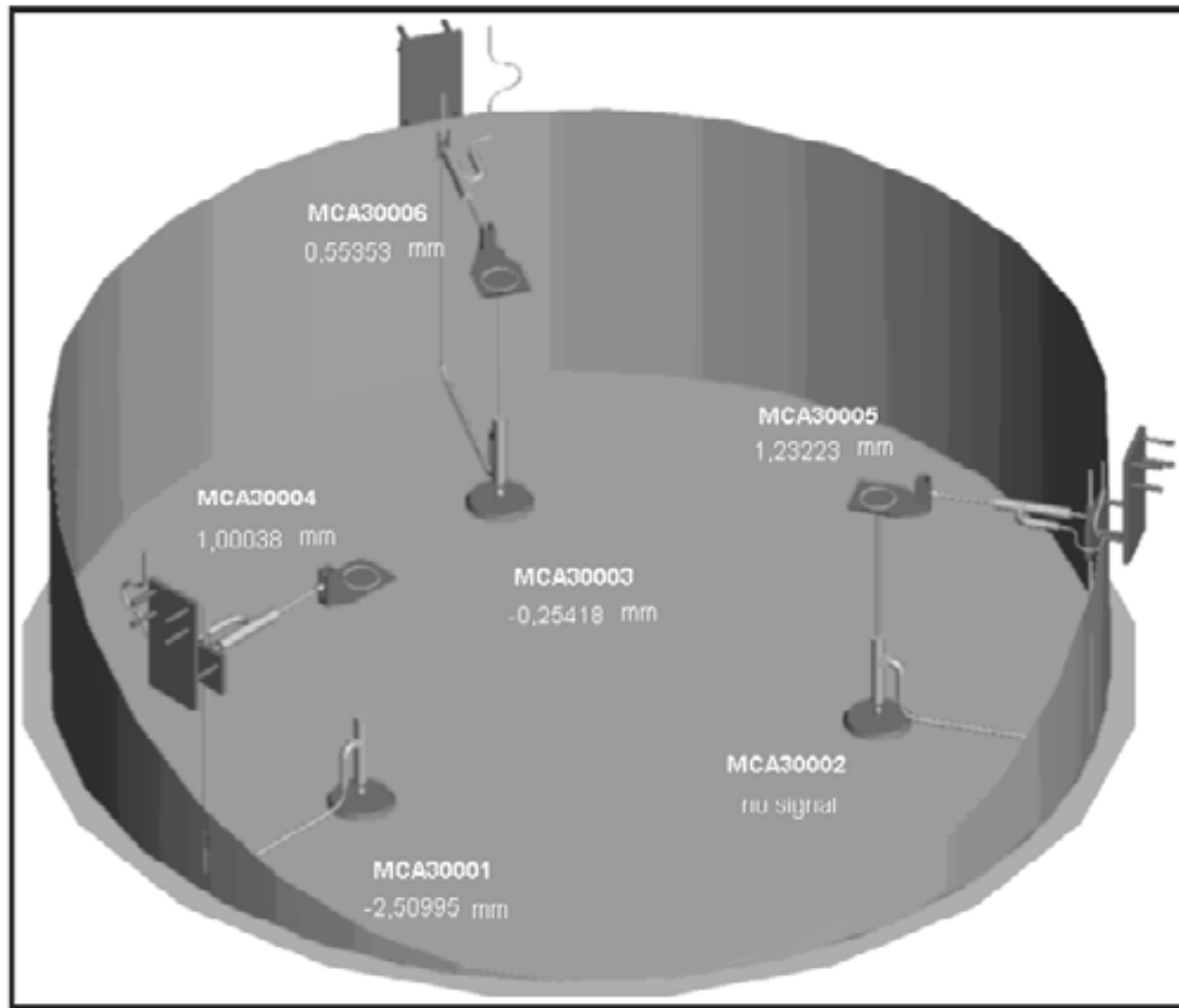
### Deposition Hole 3

MCA30001	-2,50995 mm
MCA30002	no signal
MCA30003	0,25418 mm
MCA30004	1,00000 mm
MCA30005	1,23223 mm
MCA30006	0,55353 mm

### Deposition Hole 6

MCA60001	11,10614 mm
MCA60002	-0,59552 mm
MCA60003	11,19070 mm
MCA60004	1,14874 mm
MCA60005	9,05298 mm
MCA60006	no signal

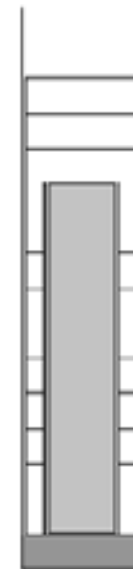
# DEPOSITION HOLE 3



Signal

Displacement

Rel. Displ.

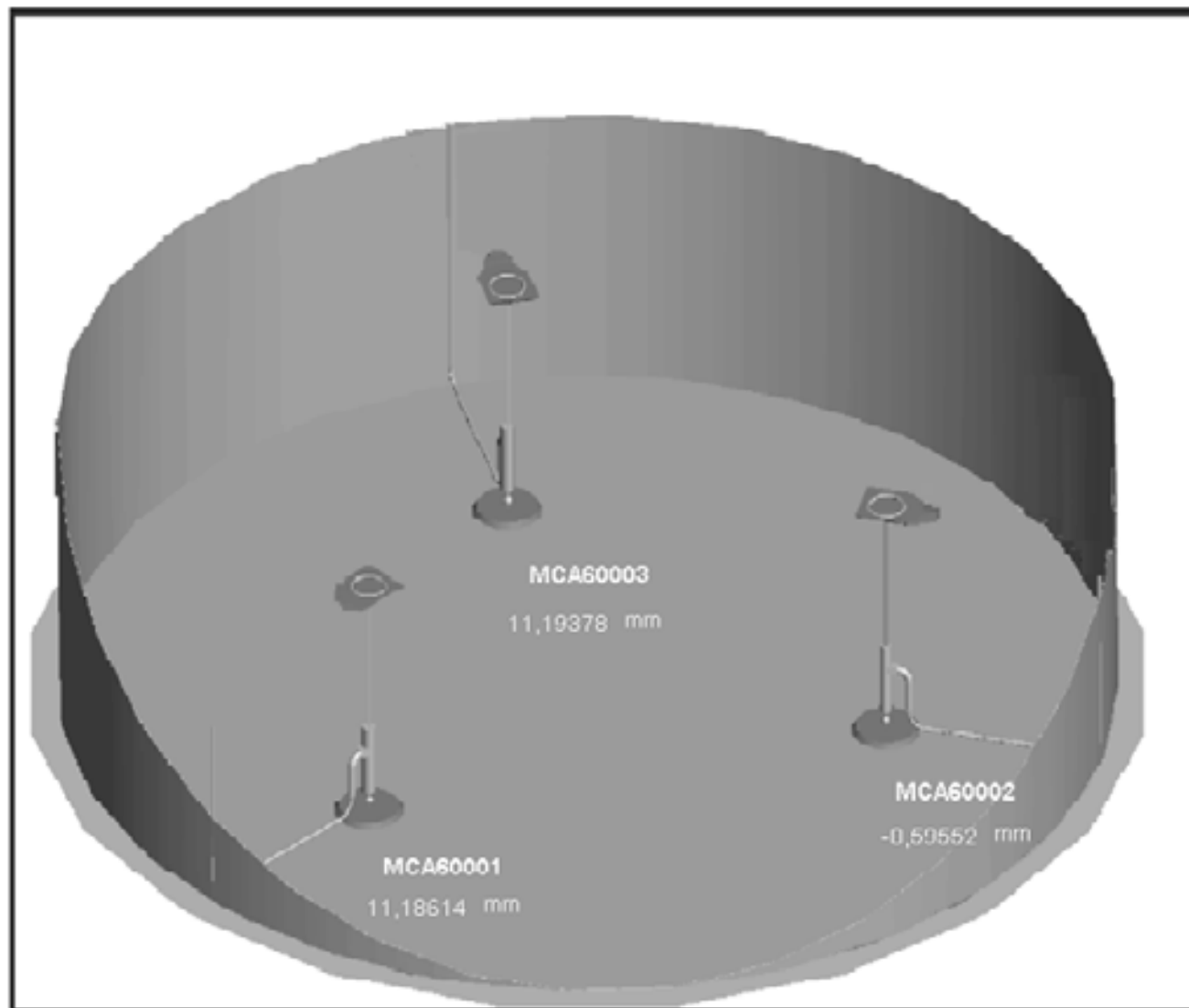


Measuring Section 1

BACK

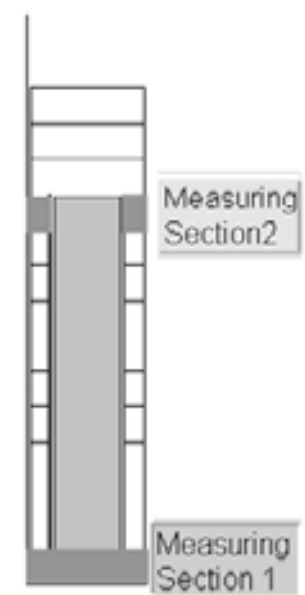


# DEPOSITION HOLE 6



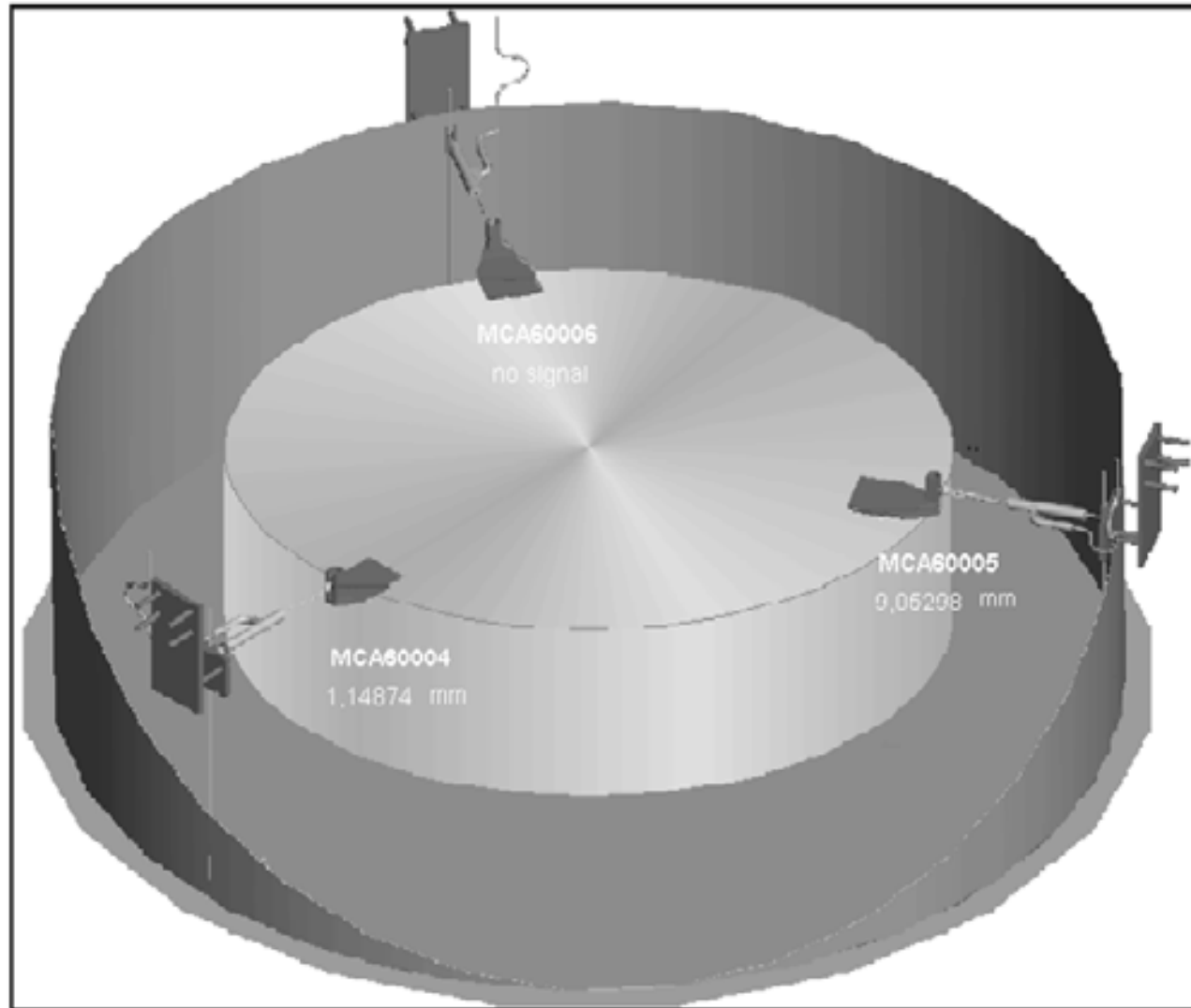
Signal Displacement

Rel. Displ.



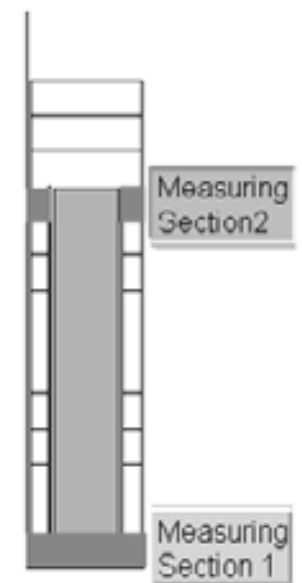
BACK

# DEPOSITION HOLE 6



Signal Displacement

Rel. Displ.



BACK

# **Appendix 9**

## **Geoelectric monitoring**

Wieczorek Klaus, GRS





Gesellschaft für Anlagen-  
und Reaktorsicherheit  
(GRS) mbH

---

# Prototype Repository Project

**Data Report  
Goelectric Monitoring**

Status: 19 July 2006

**Written by: WIE**

**Approved by: ROT**



# Contents

<b>1</b>	<b>Introduction</b>	<b>303</b>
<b>2</b>	<b>Backfill Section 1</b>	<b>305</b>
2.1	Layout of electrode array in the backfill of section 1	305
2.2	Tomograms of the backfill array in section 1	306
2.3	Actual Interpretation	309
<b>3</b>	<b>Backfill Section 2</b>	<b>317</b>
<b>4</b>	<b>Rock Section 2</b>	<b>323</b>
4.1	Layout of electrode array in the rock between deposition boreholes 5 and 6	323
4.2	Tomograms of electrode arrays in the rock	324
4.3	Actual Interpretation	325
<b>5</b>	<b>Buffer in Borehole 5 in Section 2</b>	<b>333</b>





# 1 Introduction

Within the frame of research activities in the prototype repository at Äspö GRS employs measurements of electrical resistivity to monitor water uptake in the drift backfill, the borehole buffer, and desaturation effects around one of the deposition boreholes.

The electrical resistivities in the buffer, the backfill, and around the boreholes are determined by use of multi-electrode arrays. The arrays consist of electrode chains. The resistivity distribution in the areas between the chains is determined by means of tomographic dipole-dipole measurements. The recording unit for these arrays is controlled remotely from Braunschweig / Germany via a telephone connection, which allows daily measurements of the in-situ resistivity distribution. From the measured apparent resistivity values the "true" resistivity distributions in the different parts are computed applying the latest inversion software.

In the geoelectric measurements advantage is taken of the dependence of the electrical resistivity in materials on the water (solution) content. In order to interpret the resistivity values in terms of water content the data are to be compared with laboratory calibration results which are available for the different materials.

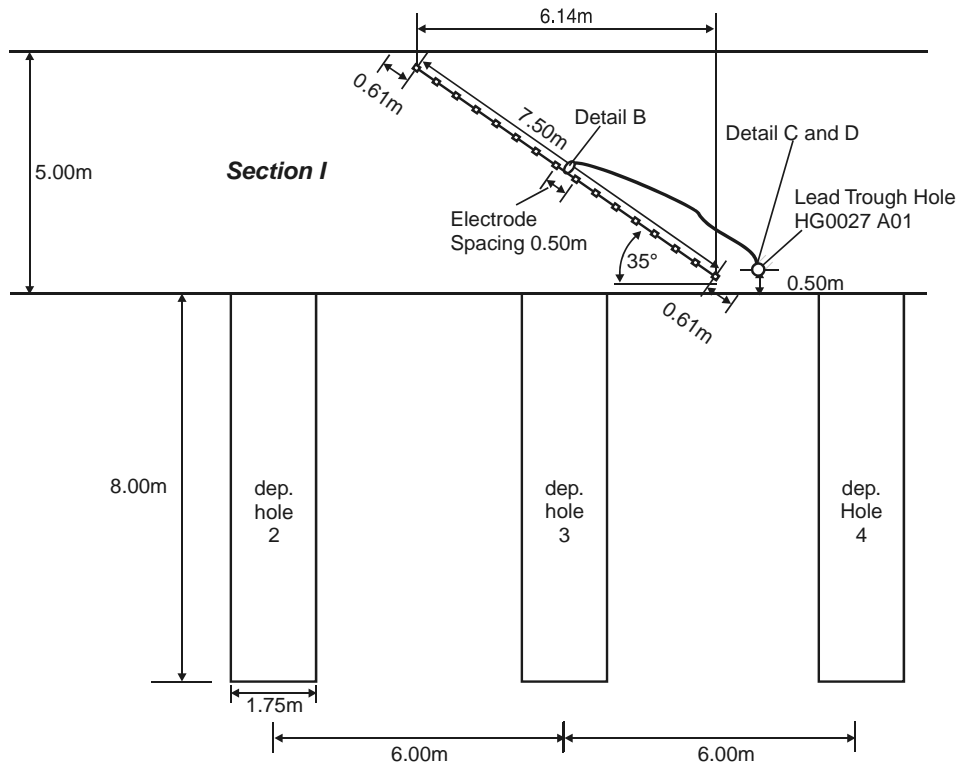
In the following, quarterly calculated inversion data for the different arrays are provided in the form of tomograms. Additional data for smaller time periods can be made available on demand. The tomograms of February 2006 are missing due to problems with the geoelectric system which have been overcome.



## 2 Backfill Section 1

### 2.1 Layout of electrode array in the backfill of section 1

#### Vertical Cross section



#### Plan View

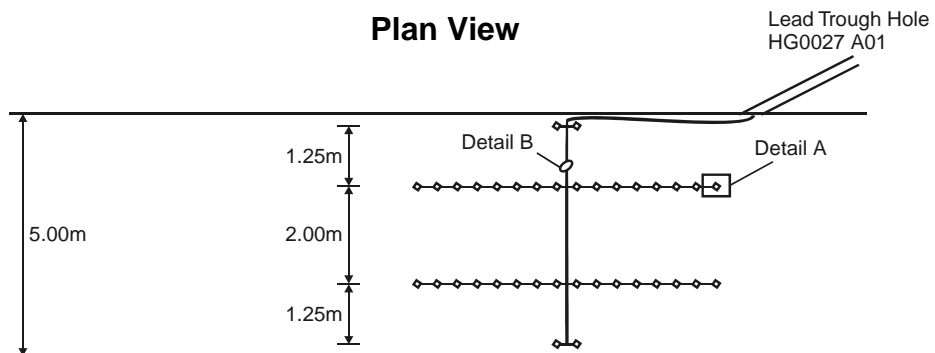
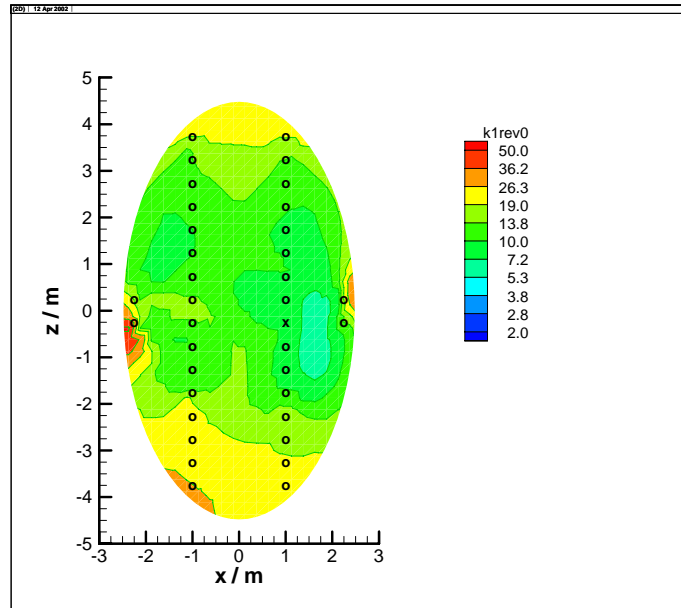
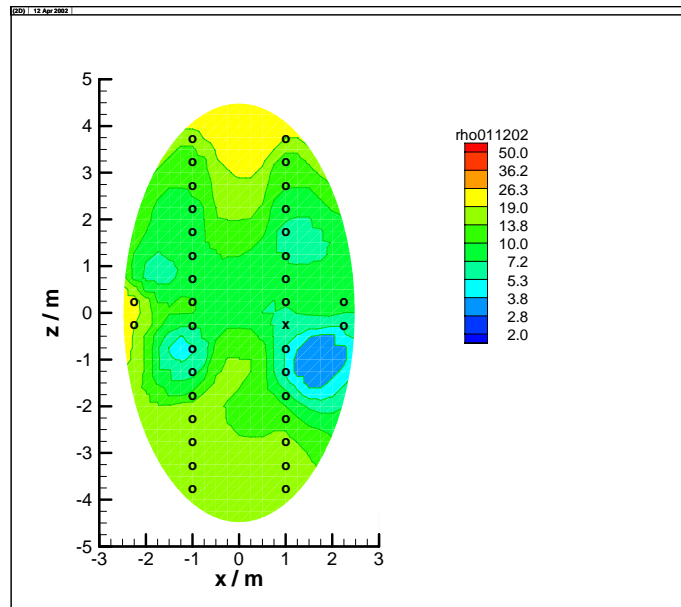


Figure 2-1: Electrode array in the backfill in section 1.

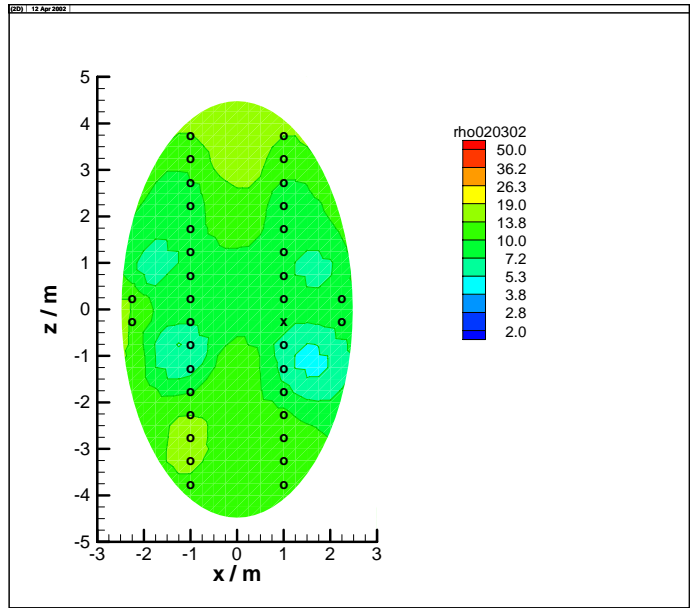
## 2.2 Tomograms of the backfill array in section 1



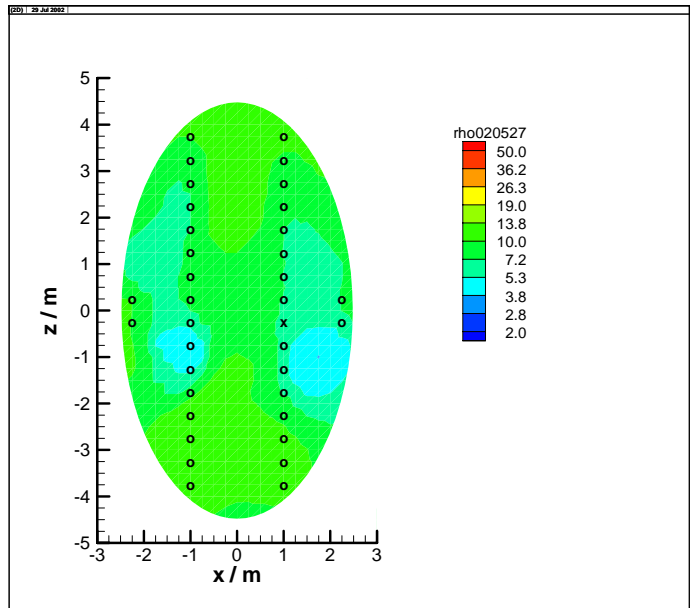
2001-10-27



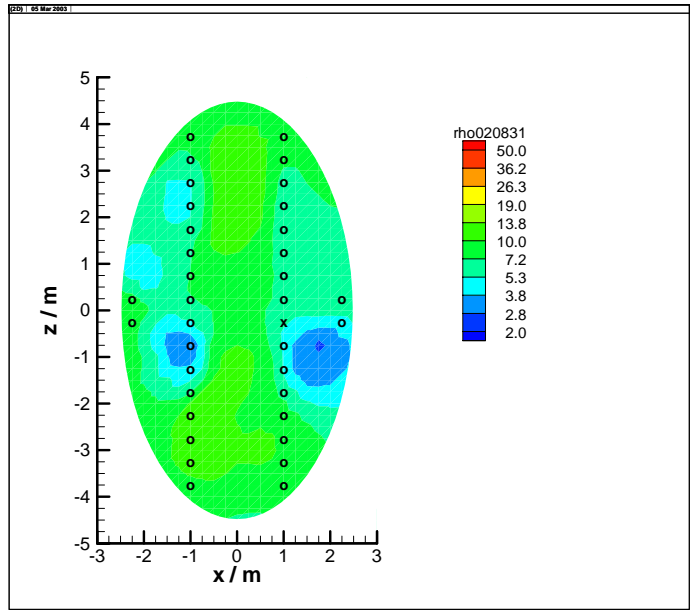
2001-12-02



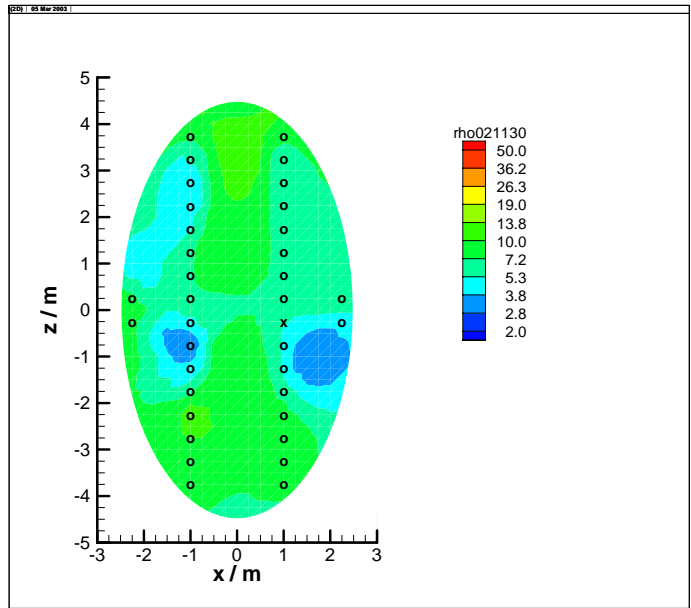
2002-03-02



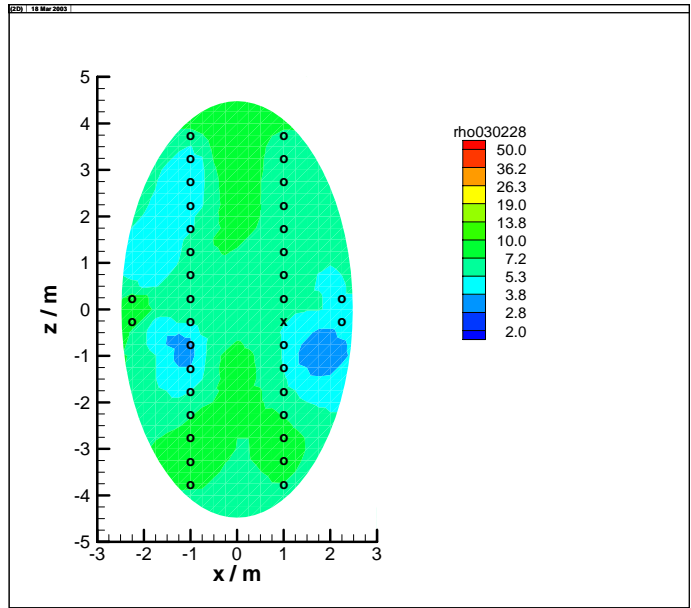
2002-05-27



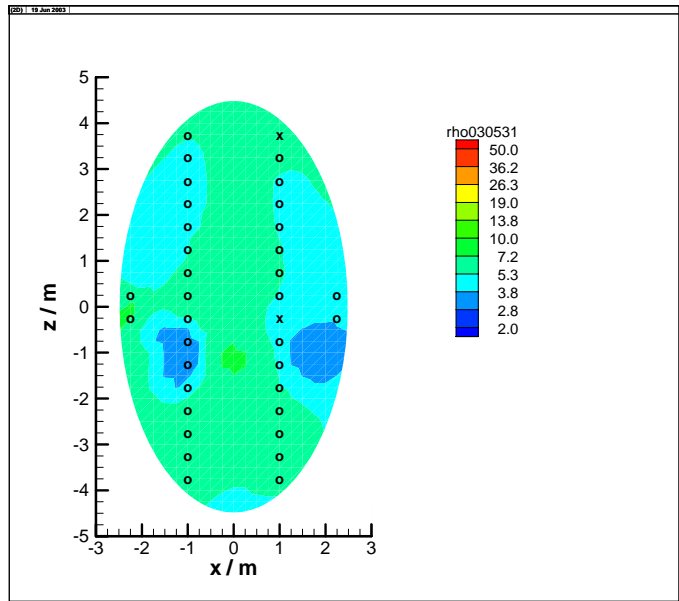
2002-08-31



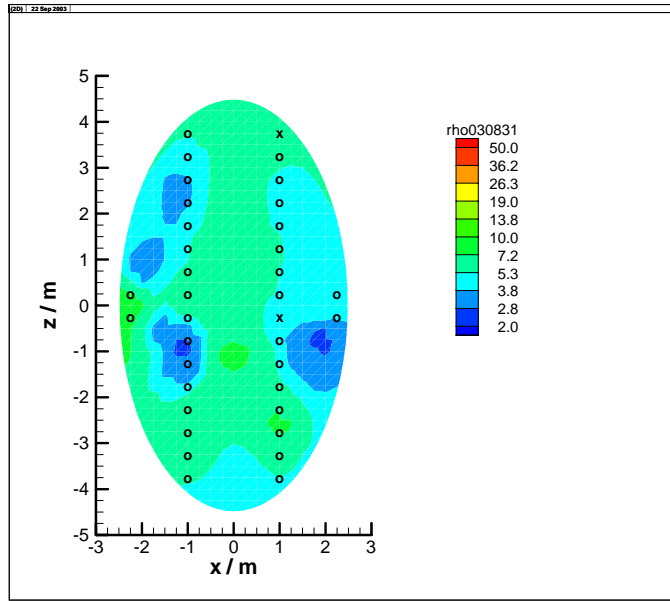
2002-11-30



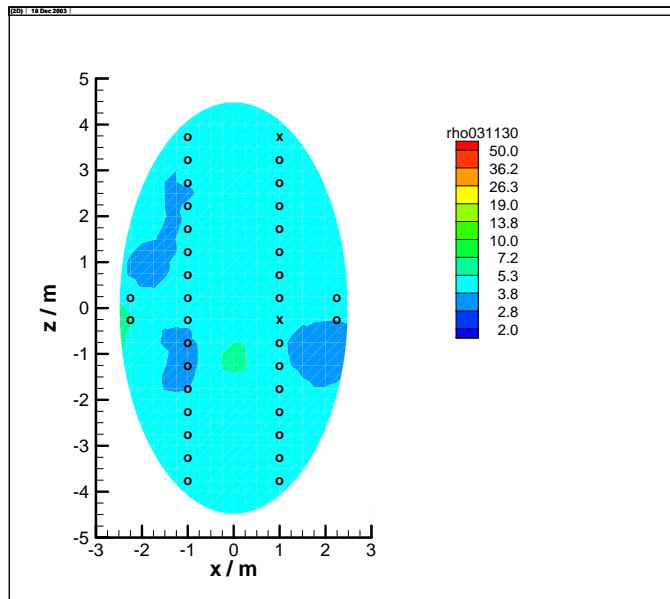
2003-02-28



2003-05-31

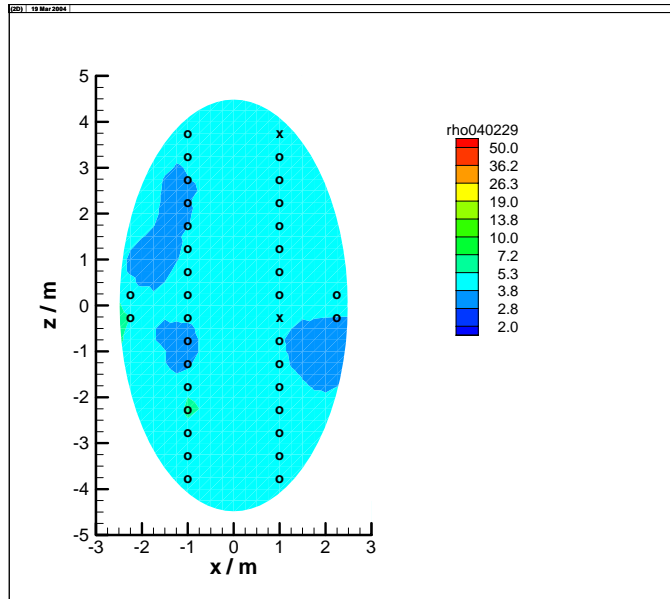


2003-08-31

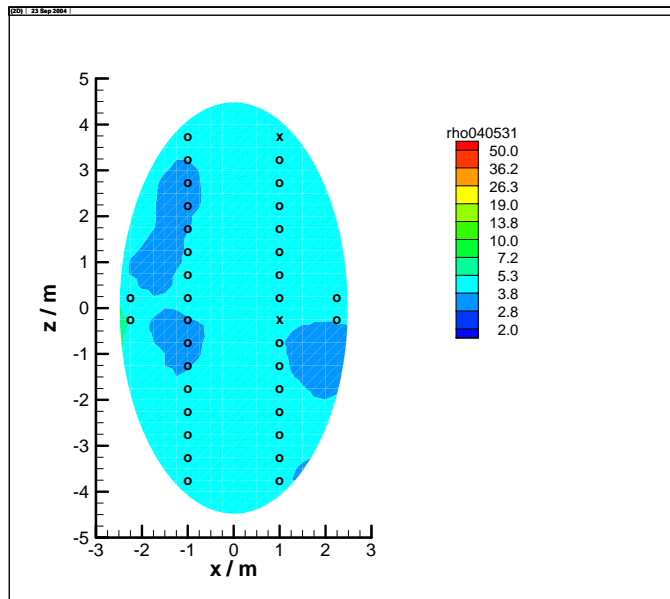


2003-11-30

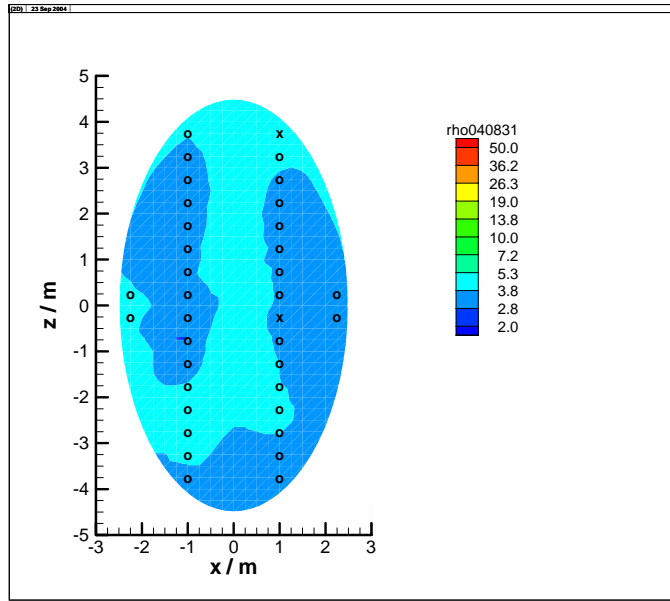




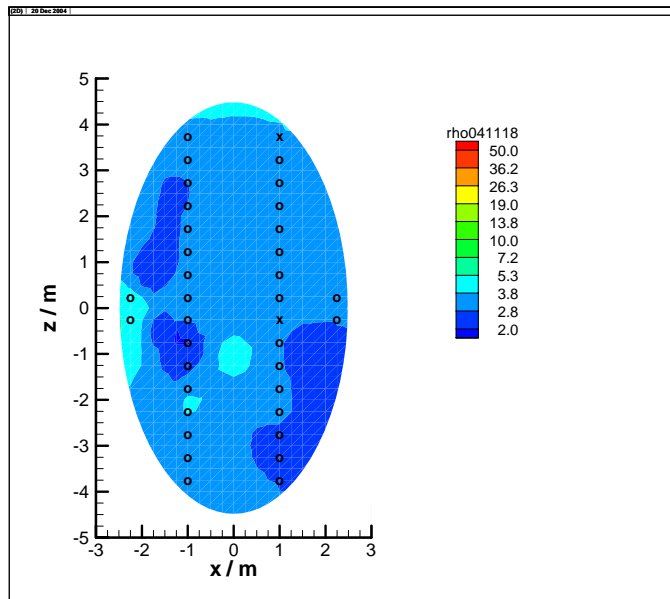
2004-02-29



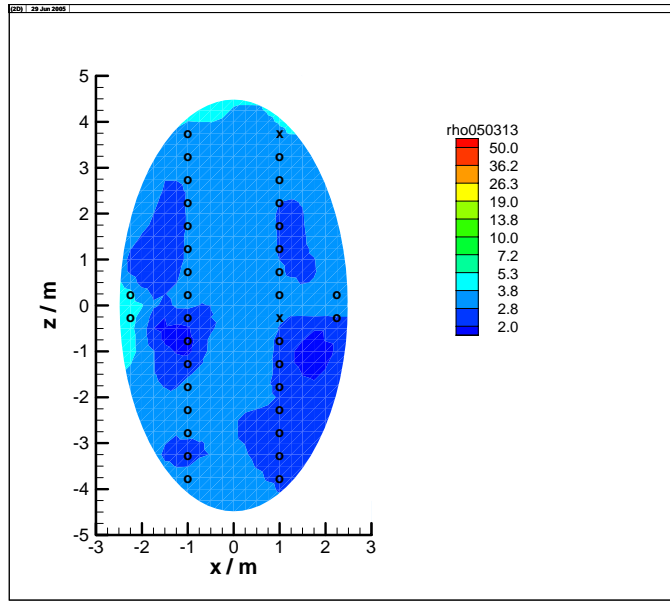
2004-05-31



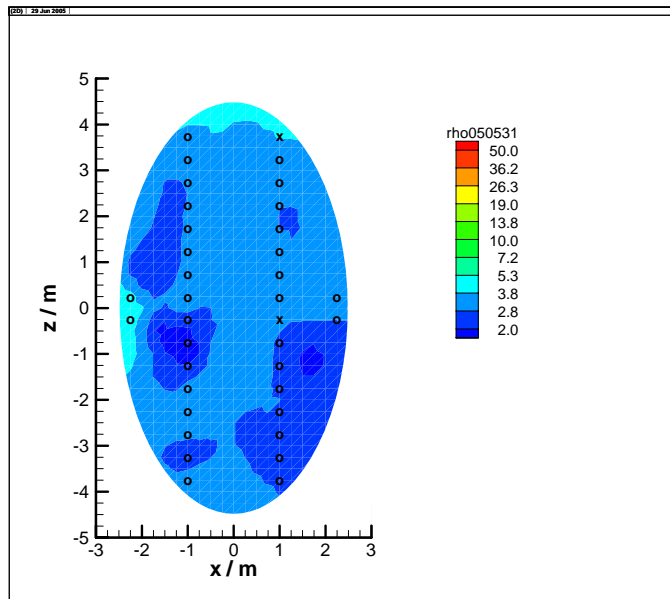
2004-08-31



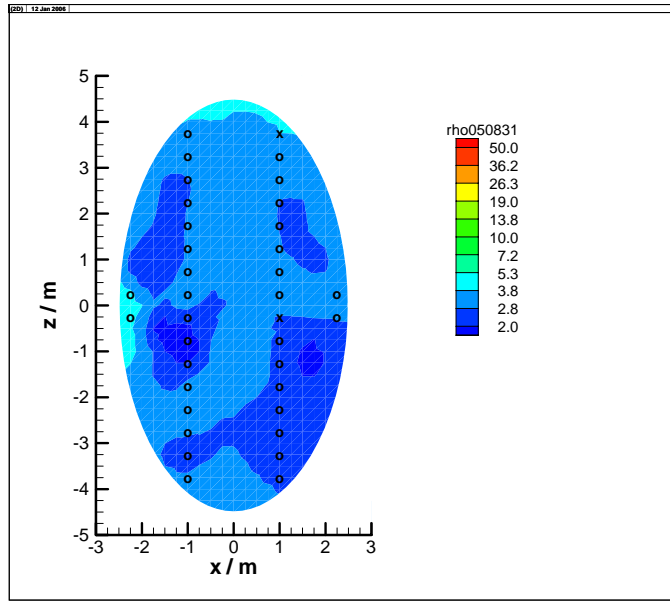
2004-11-18



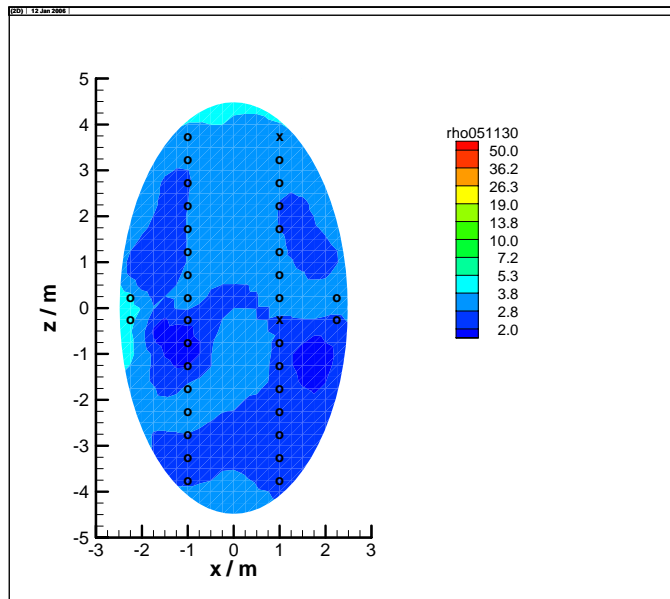
2005-03-13



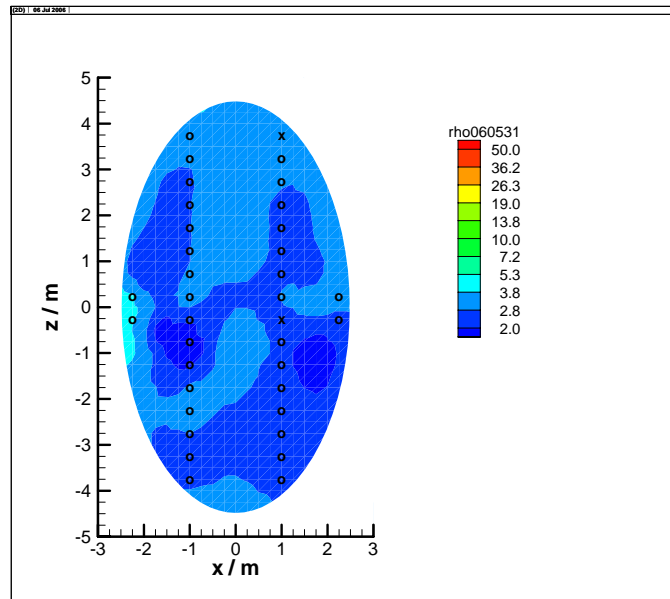
2005-05-31



2005-08-31



2005-11-30



2006-05-31

### 2.3 Actual Interpretation

The initial resistivity value of the backfill in October 2001 is about 10 to 14  $\Omega\text{m}$  corresponding to a water content of 13 to 14%. In the following month the resistivity reduces to about 7 to 10  $\Omega\text{m}$  which corresponds to a water content of about 14 to 16%. However, this reduction in resistivity is most likely generated by the wet (light blue) areas close to the electrode chains. These wet areas are the consequence of moistened backfill used during installation of the electrodes for better covering of the electrode chains. From then on, the resistivity decreases continuously, starting near the drift walls and progressing into the drift centre. Since November 2004, a very homogeneous resistivity distribution has been reached; with a value around 3  $\Omega\text{m}$  corresponding to a water content of 21 - 22 %. Resistivity is still slowly decreasing, but the backfill is not far from full saturation.

Besides this overall trend, minor changes in the tomograms from month to month are visible near the edges of the gallery, especially a light blue area on the right side of the tomograms is more or less pronounced. These are no real anomalies, but are caused by the fact that inaccuracies in the measurements can lead to the accumulation of "ghost" anomalies in areas of lower sensitivity. The areas of lower sensitivity are typically the edges of the model. In case of the blue area on the right side of the tomograms, the sensitivity is more reduced because one of the electrodes (marked with an "x" in the tomograms) is not active, as its cable broke after installation during backfilling.

The resistivity is also slightly decreased by the temperature increase in the backfill. The temperature increase can result in a resistivity reduction by not more than 1  $\Omega\text{m}$ .

On May 2, 2003, the upper right electrode (also marked with an "x" in the tomogram from May 31, 2003) was lost. The reason is probably a cable failure. It is not clear whether this is already a corrosion effect.

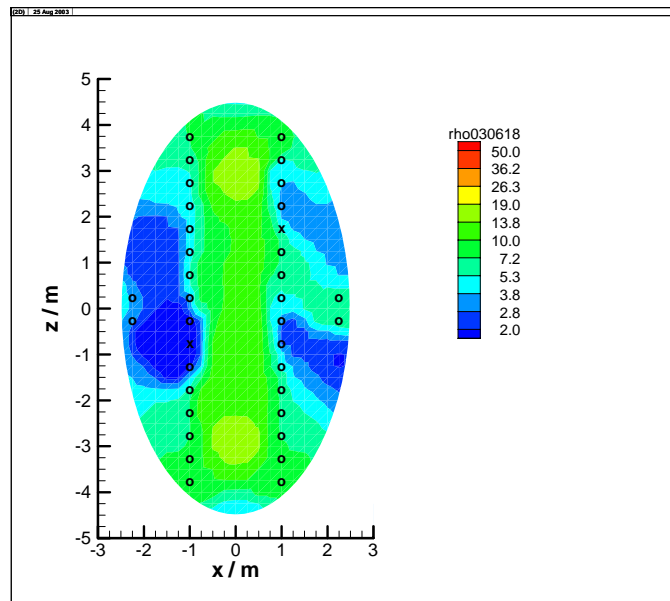


### 3 Backfill Section 2

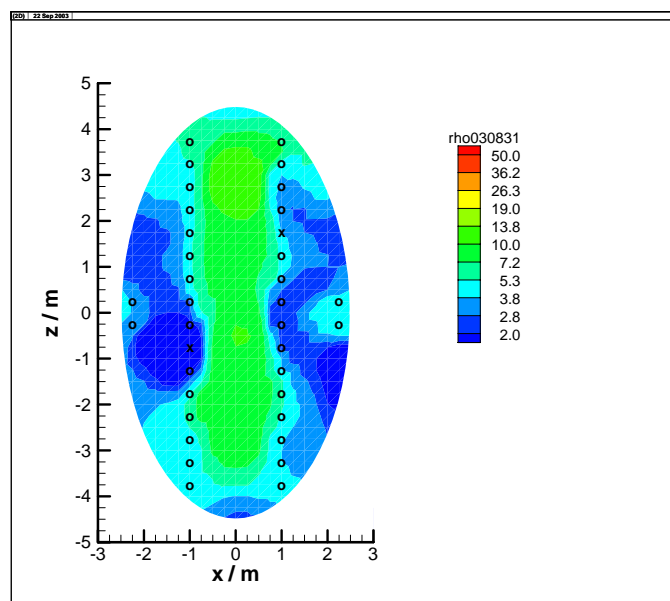
#### 3.1 Layout of electrode array in the backfill of section 2

The array layout in the backfill of section 2 is identical to that located in section 1, except for the fact that the array has been placed above deposition borehole #6 instead of #3.

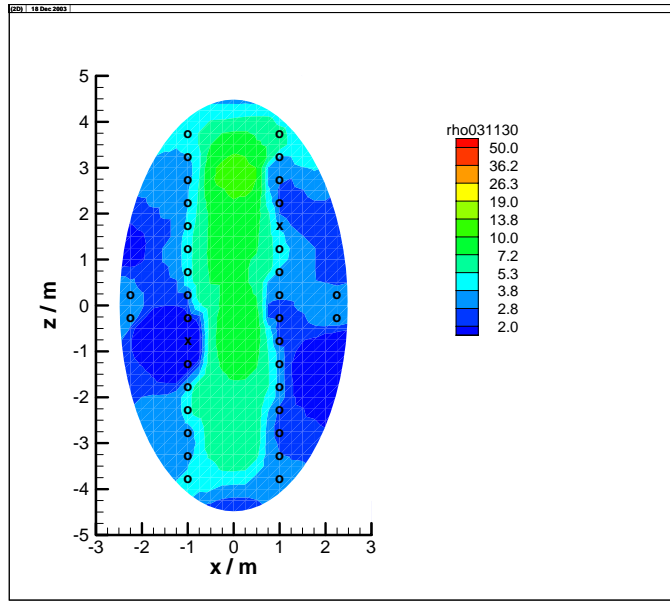
#### 3.2 Tomograms of the backfill array in section 2



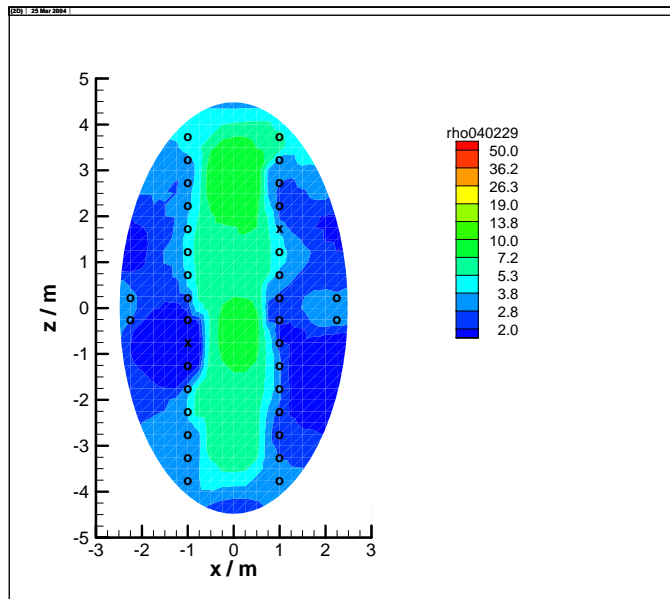
2003-06-18



2003-08-31

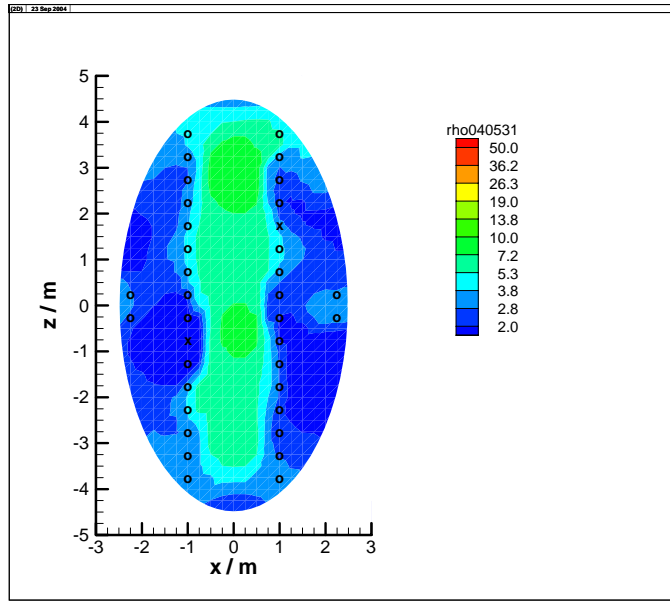


2003-11-30

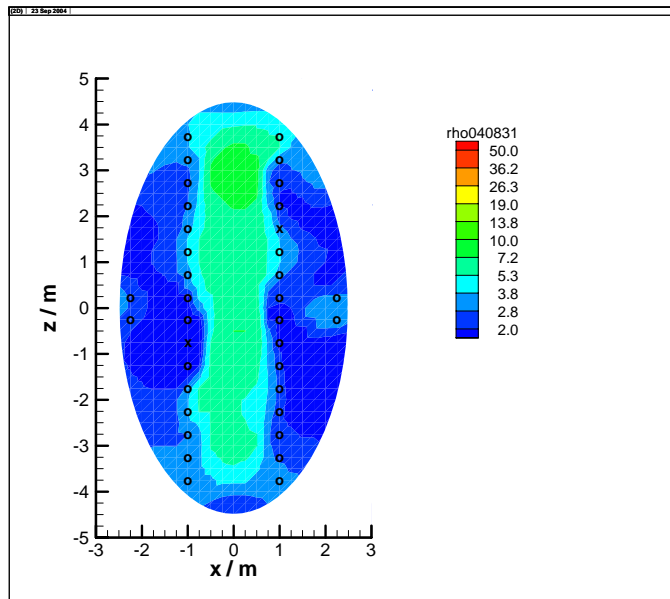


2004-02-29

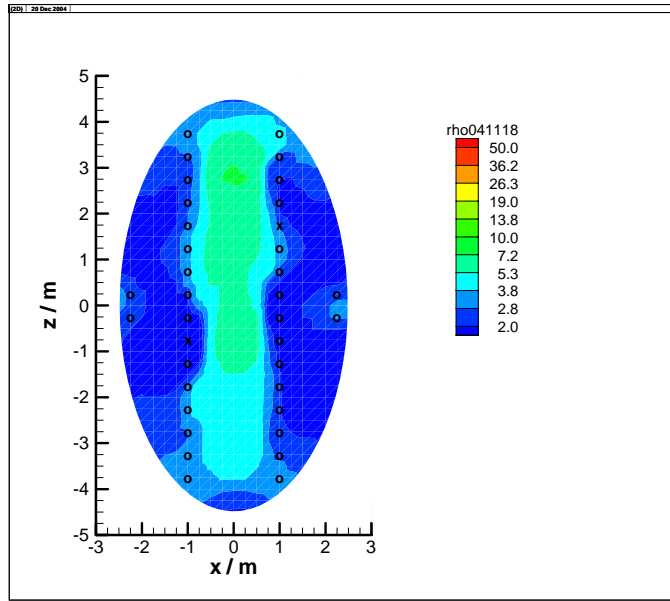




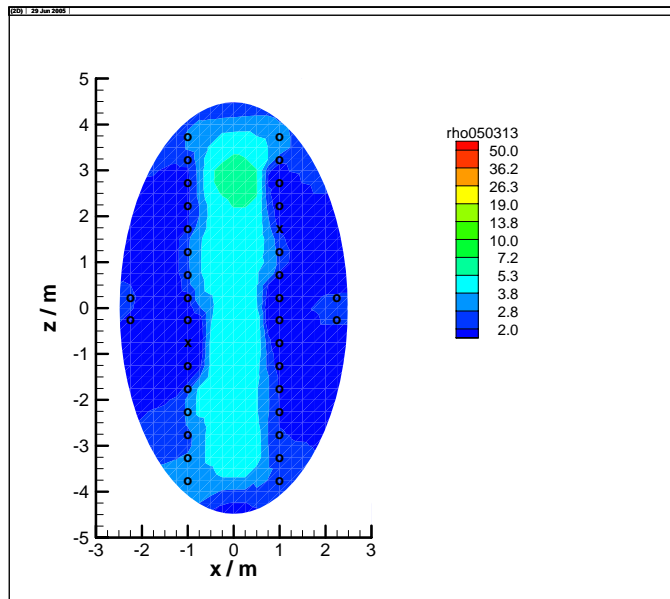
2004-05-31



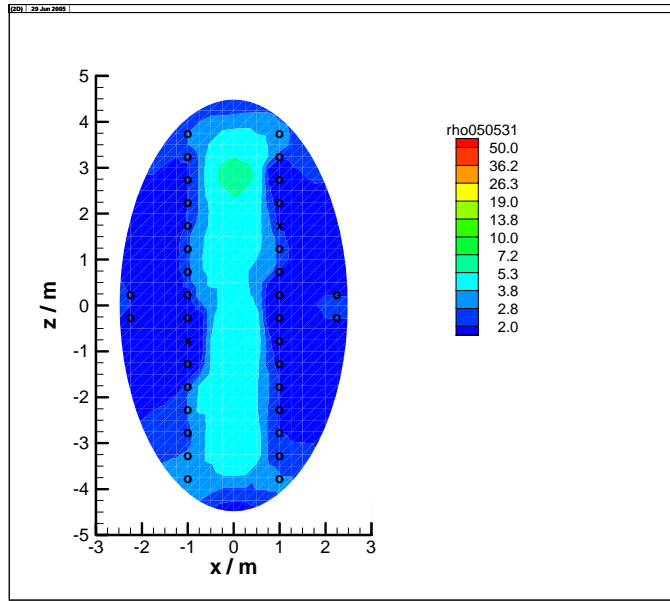
2004-08-31



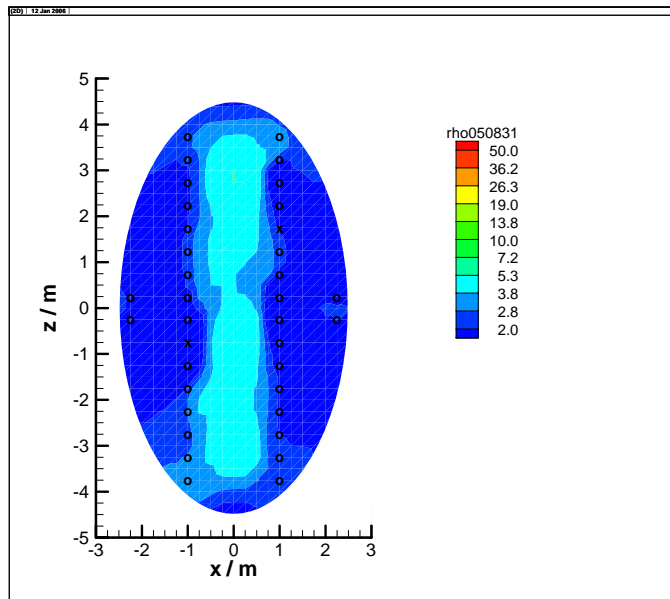
2004-11-18



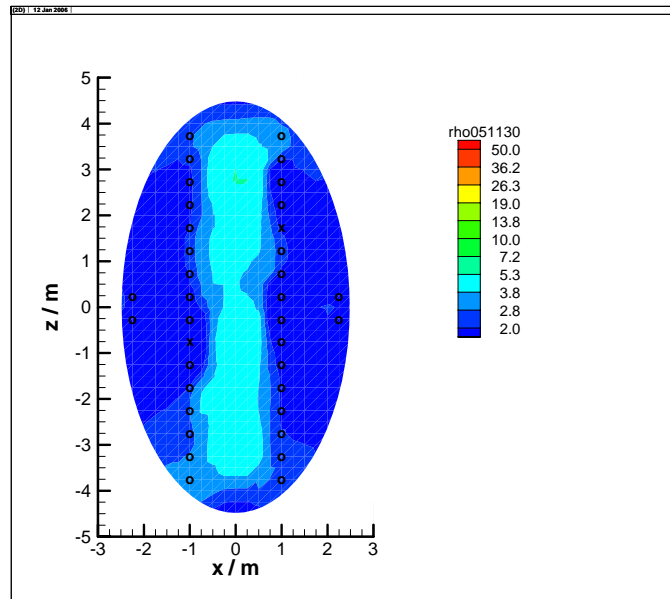
2005-03-13



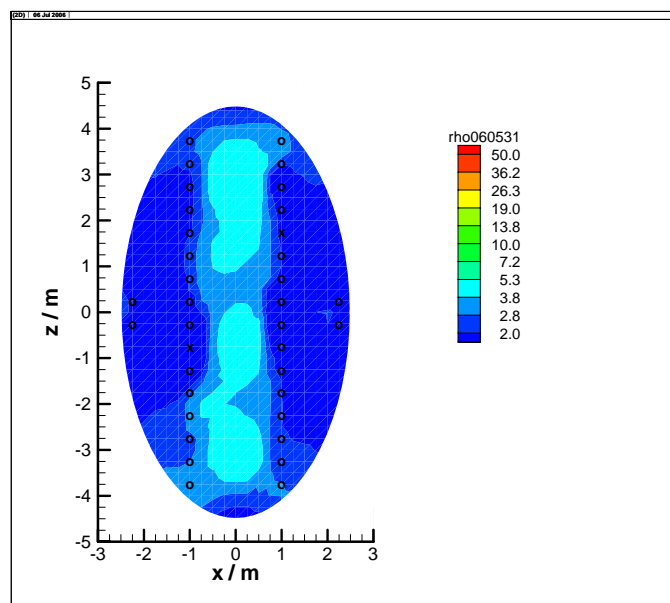
2005-05-31



2005-08-13



2005-11-30



2006-05-31

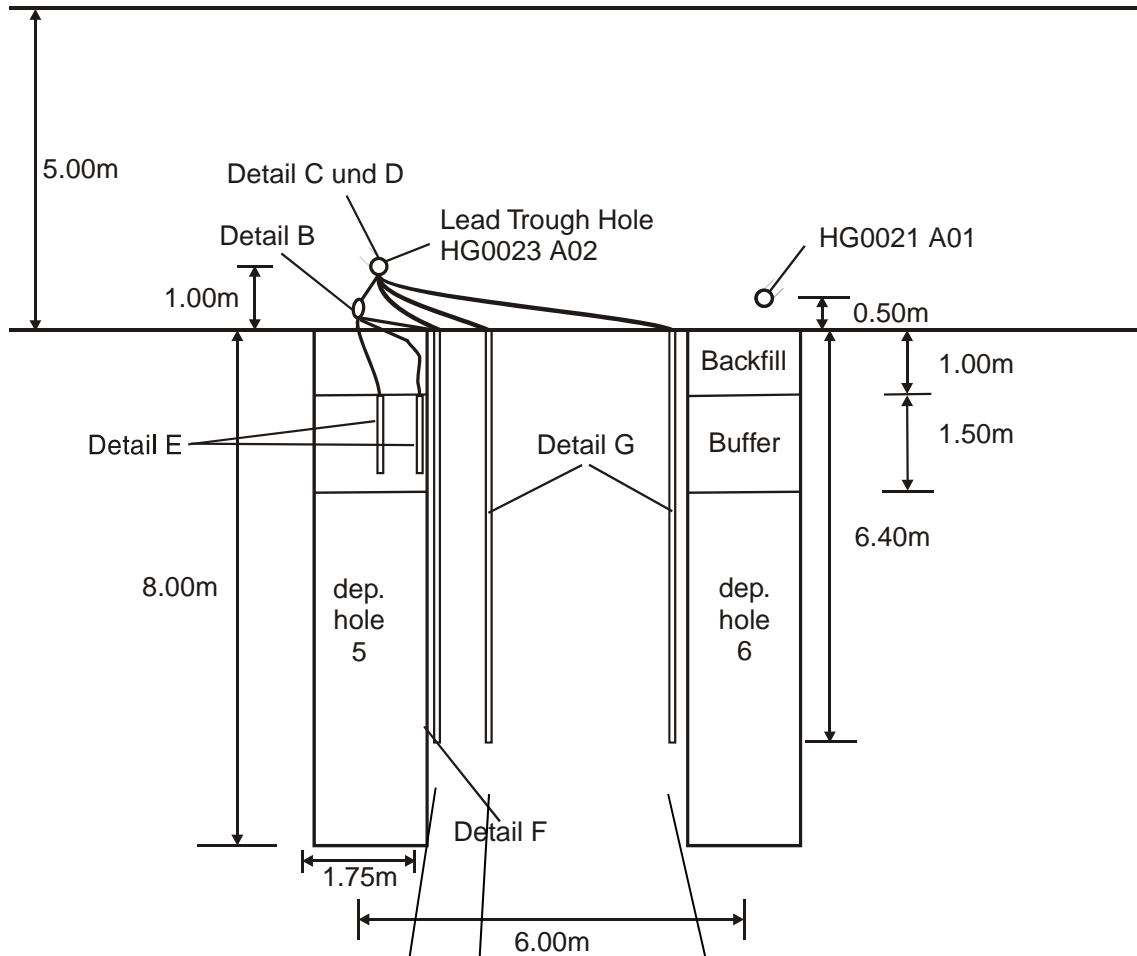
### 3.3 Actual Interpretation

The first measurement performed on June 18, 2003 in section 2 shows a much lower resistivity than the early measurements in section 1. Obviously, the backfill had a considerably higher water content already during installation. This observation was also made during instrumentation. Resistivity is decreasing further from the drift walls. Close to the walls it ranges below  $3 \Omega\text{m}$ ; the backfill is therefore not far from full saturation. In the centre resistivity has decreased to values around  $3 \Omega\text{m}$  corresponding to a water content of 21 to 22%. The central area of higher resistivity is continuously decreasing in size.

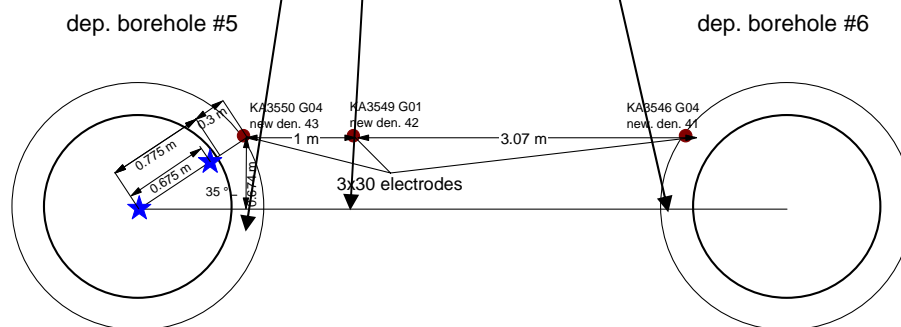
## 4 Rock Section 2

### 4.1 Layout of electrode array in the rock between deposition boreholes 5 and 6

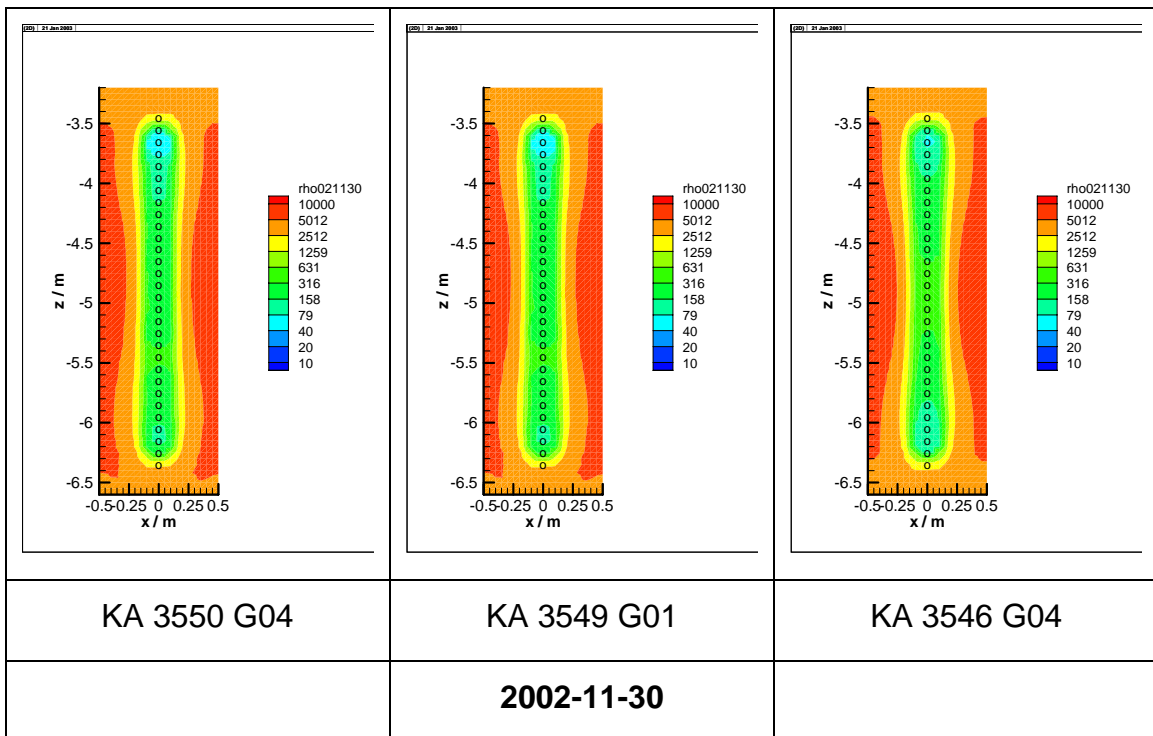
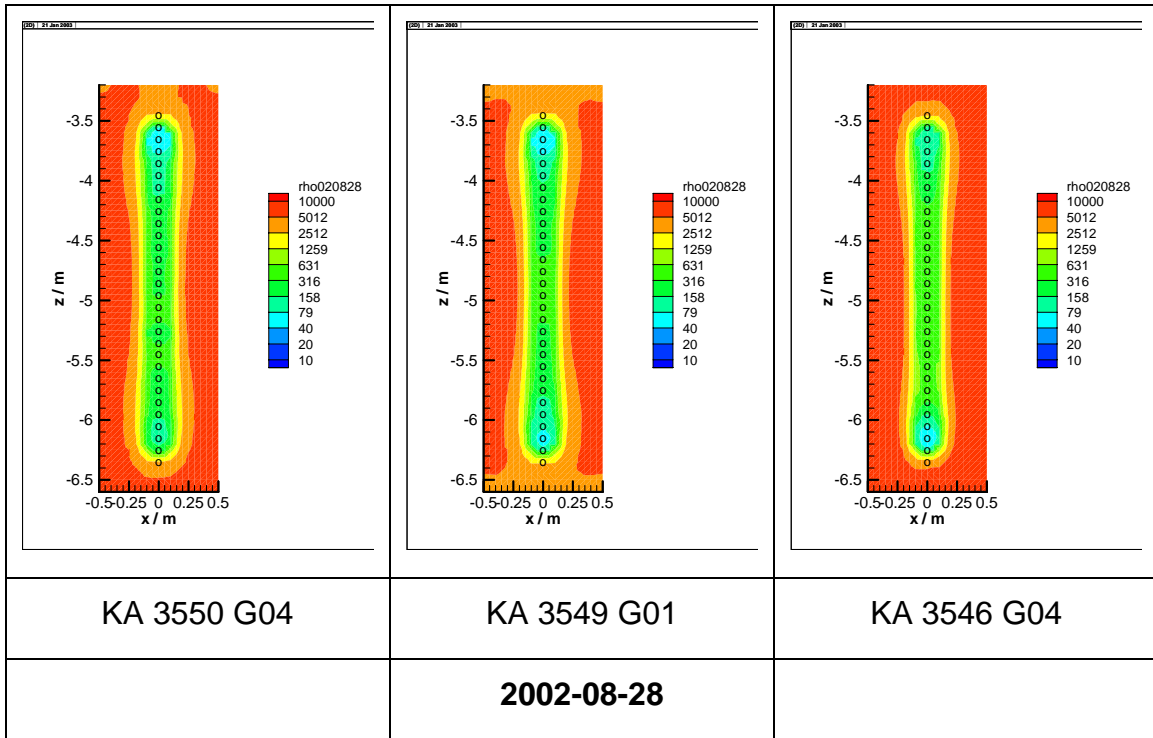
#### A) Vertical cross section

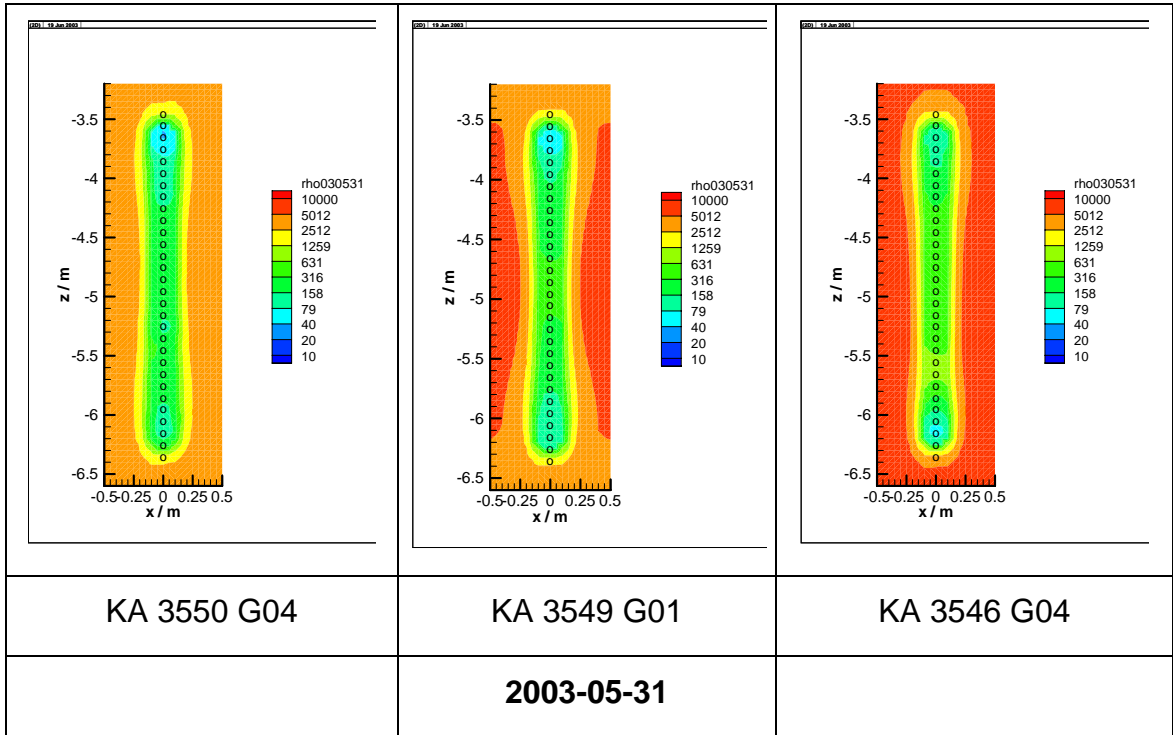
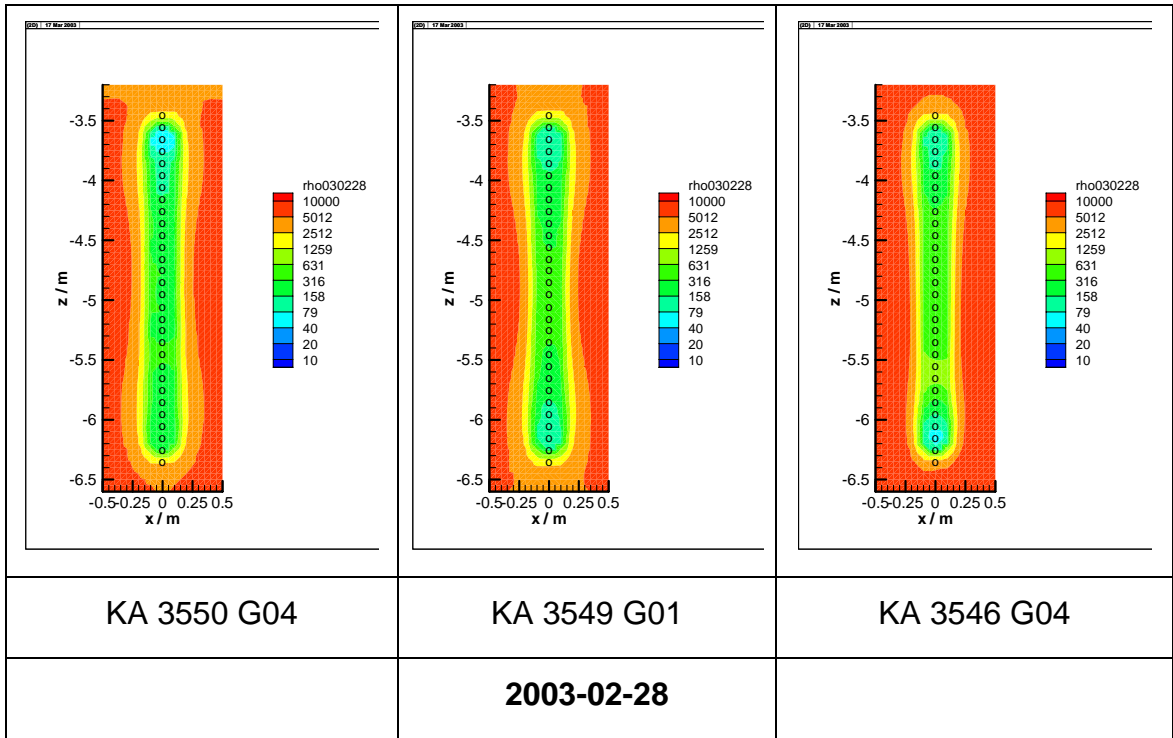


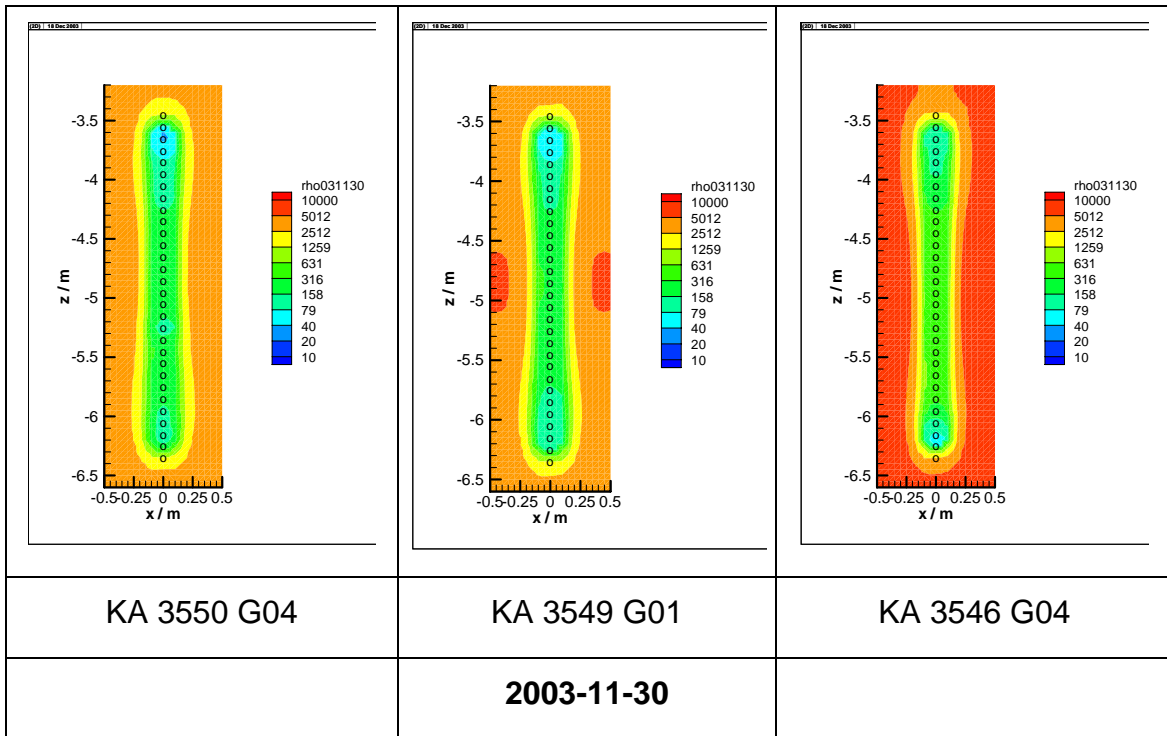
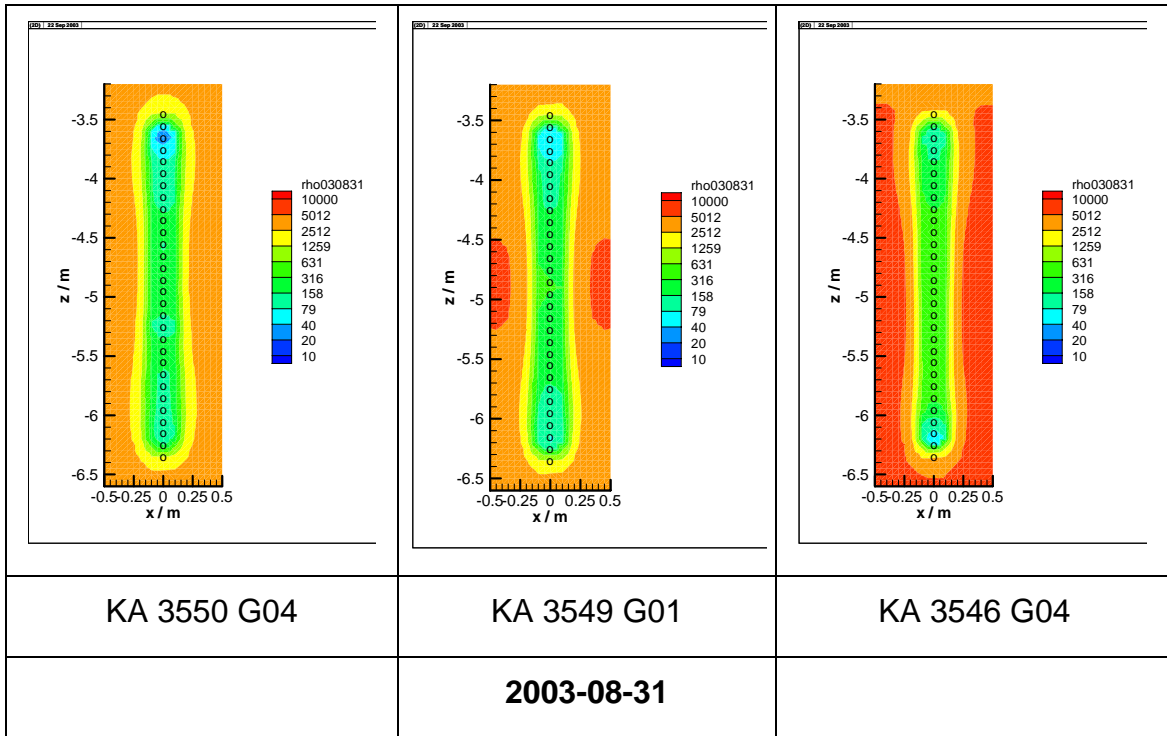
#### B) Plan view



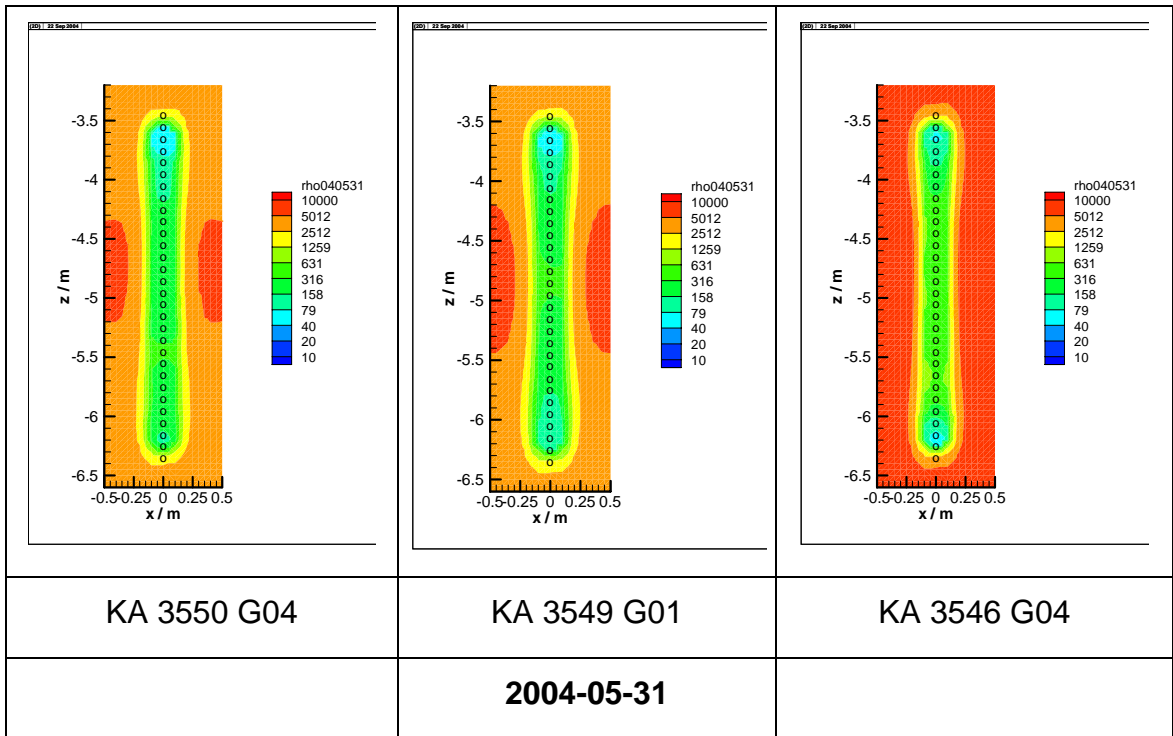
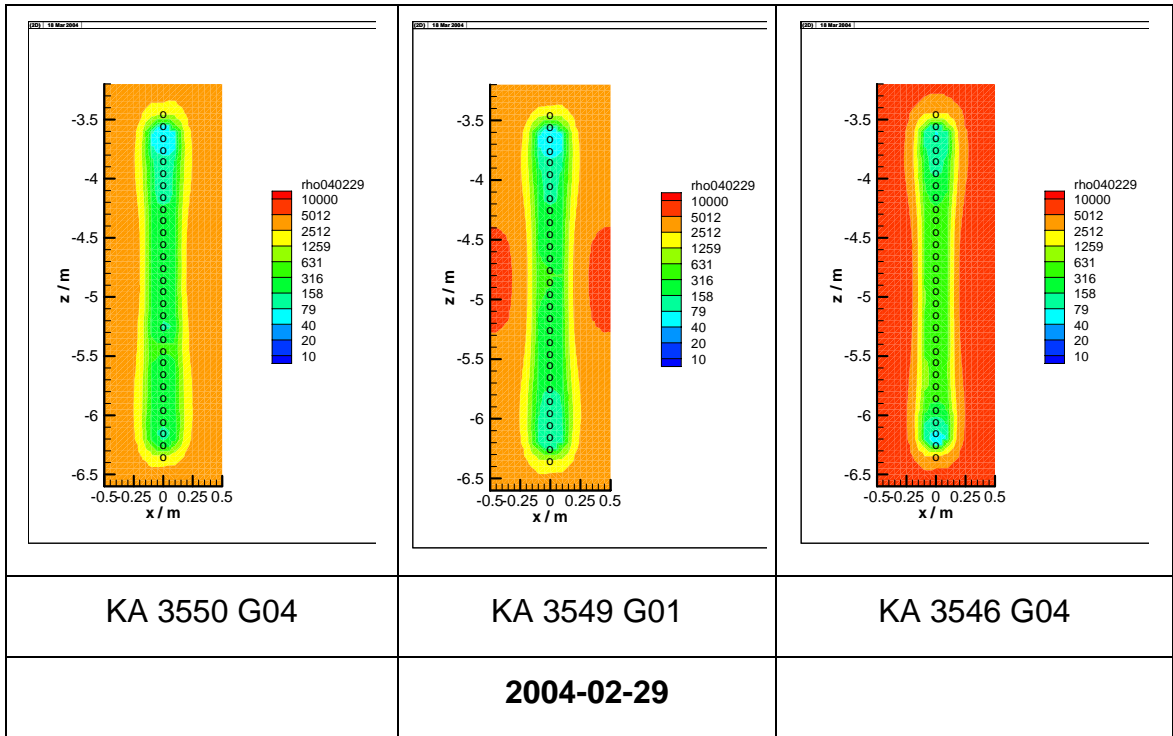
## 4.2 Tomograms of electrode arrays in the rock

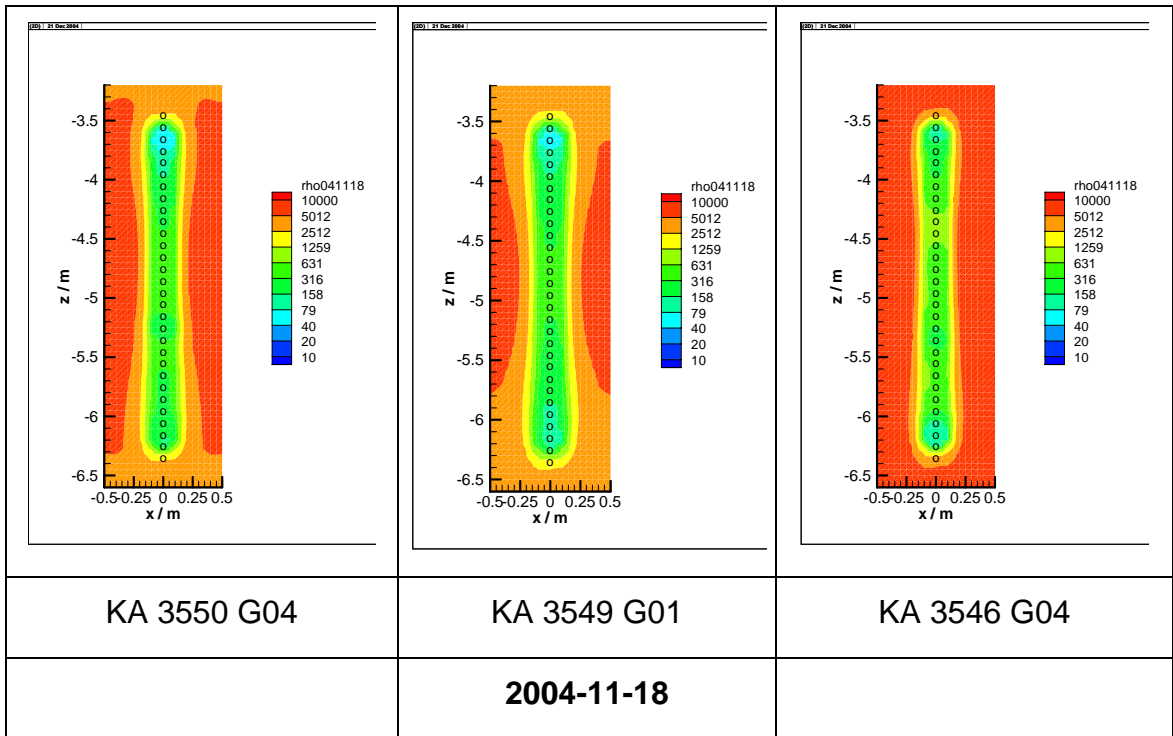
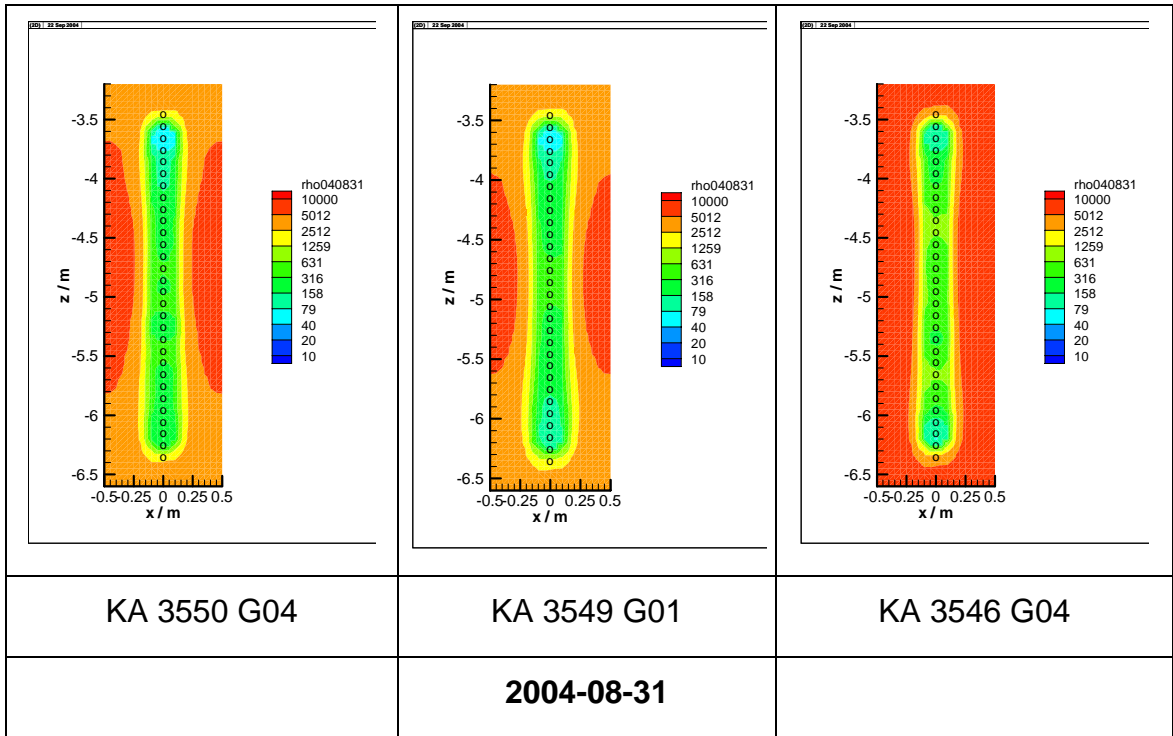


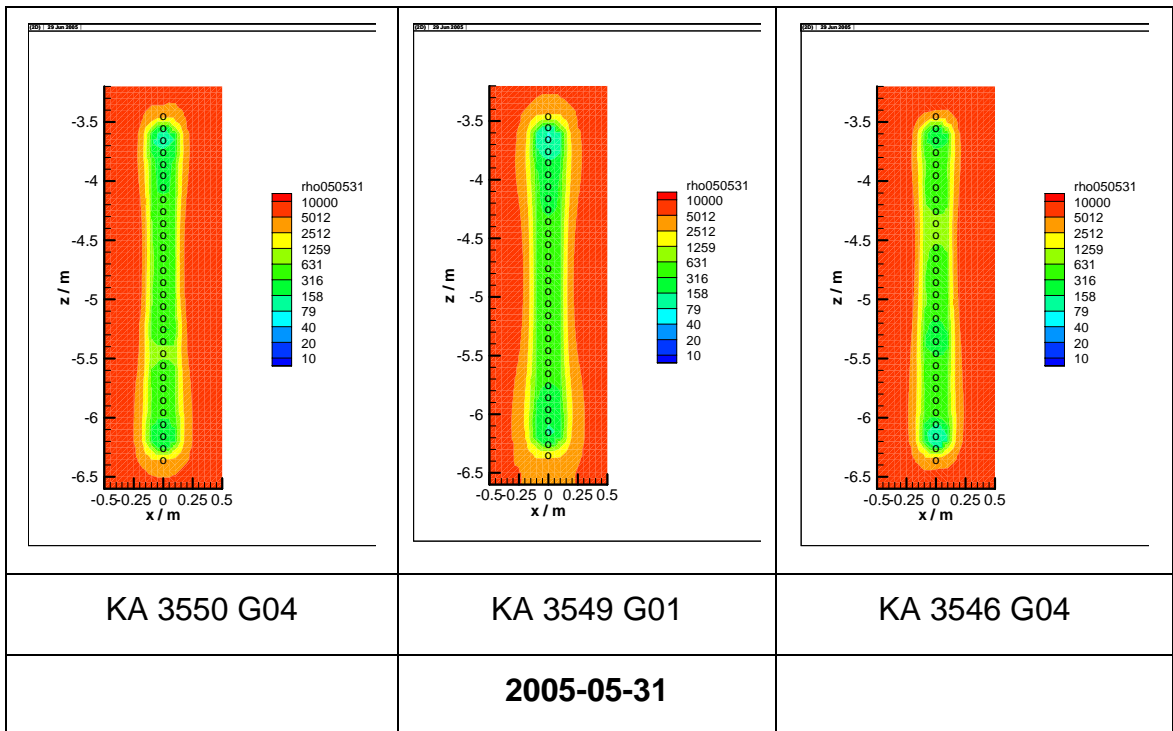
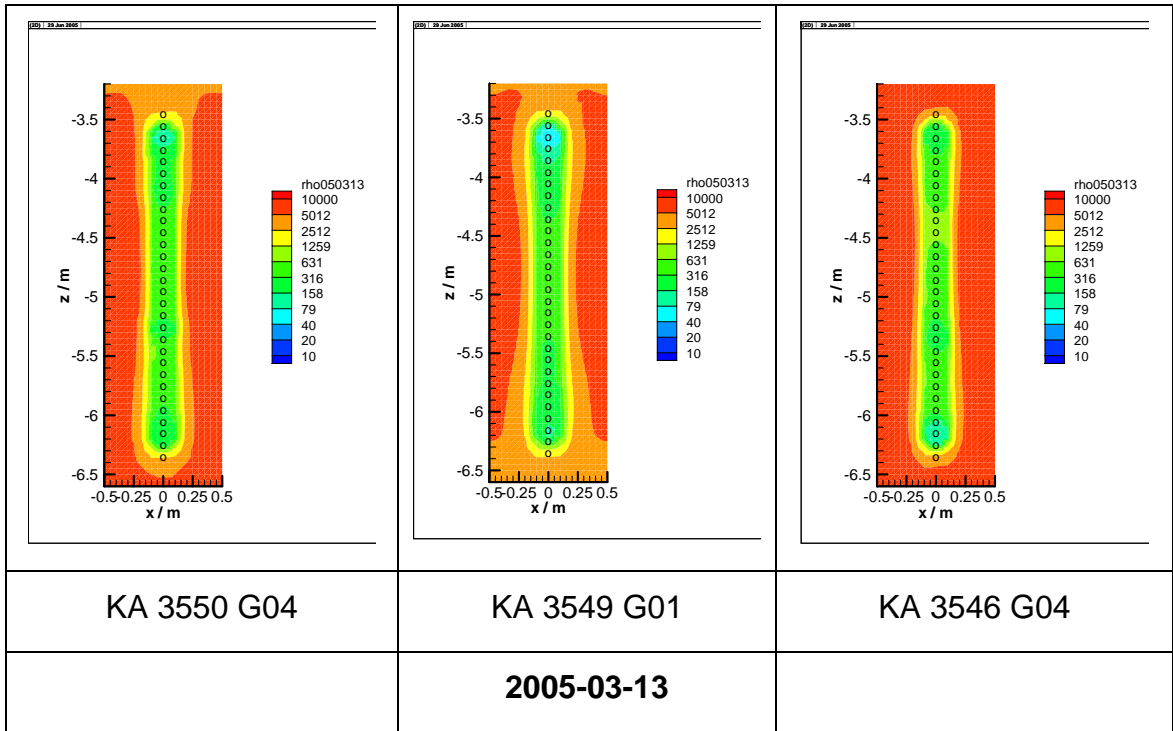


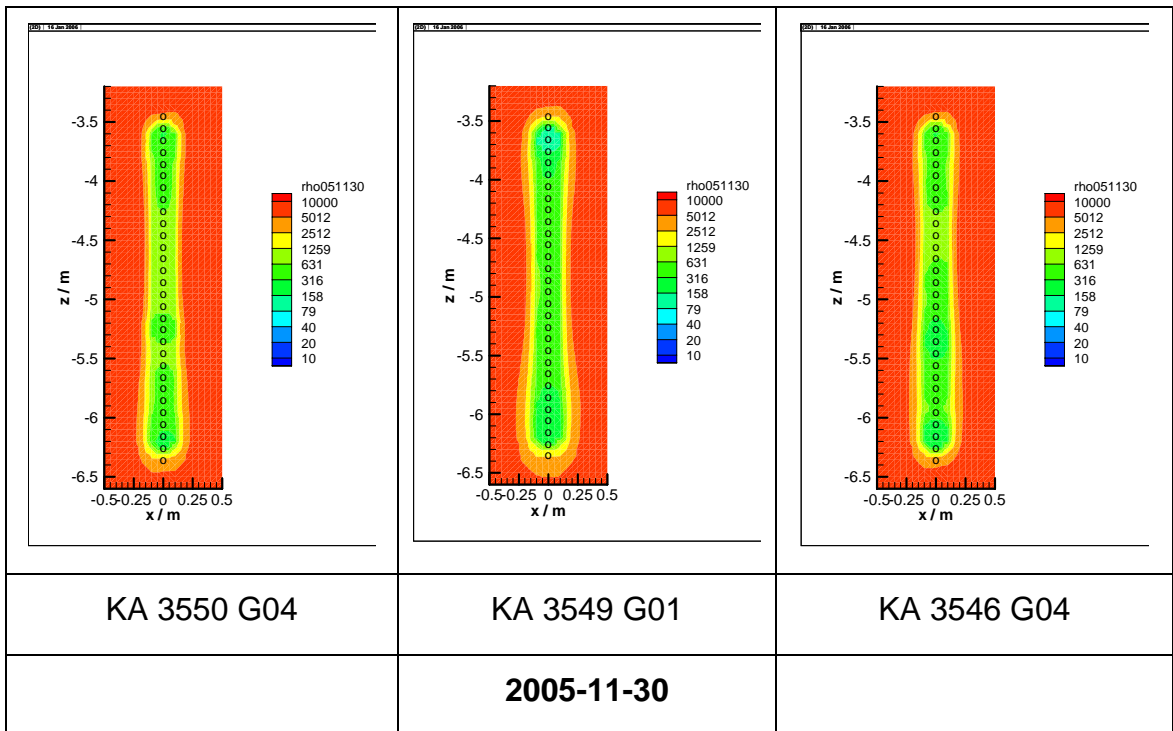
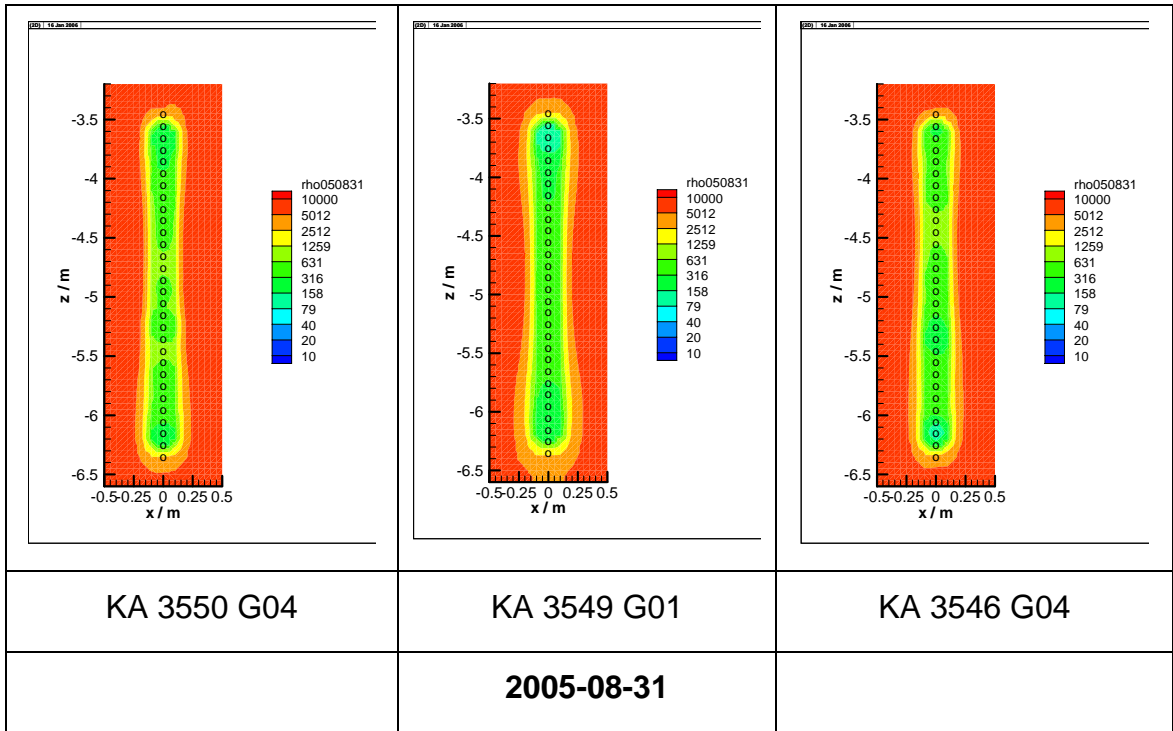


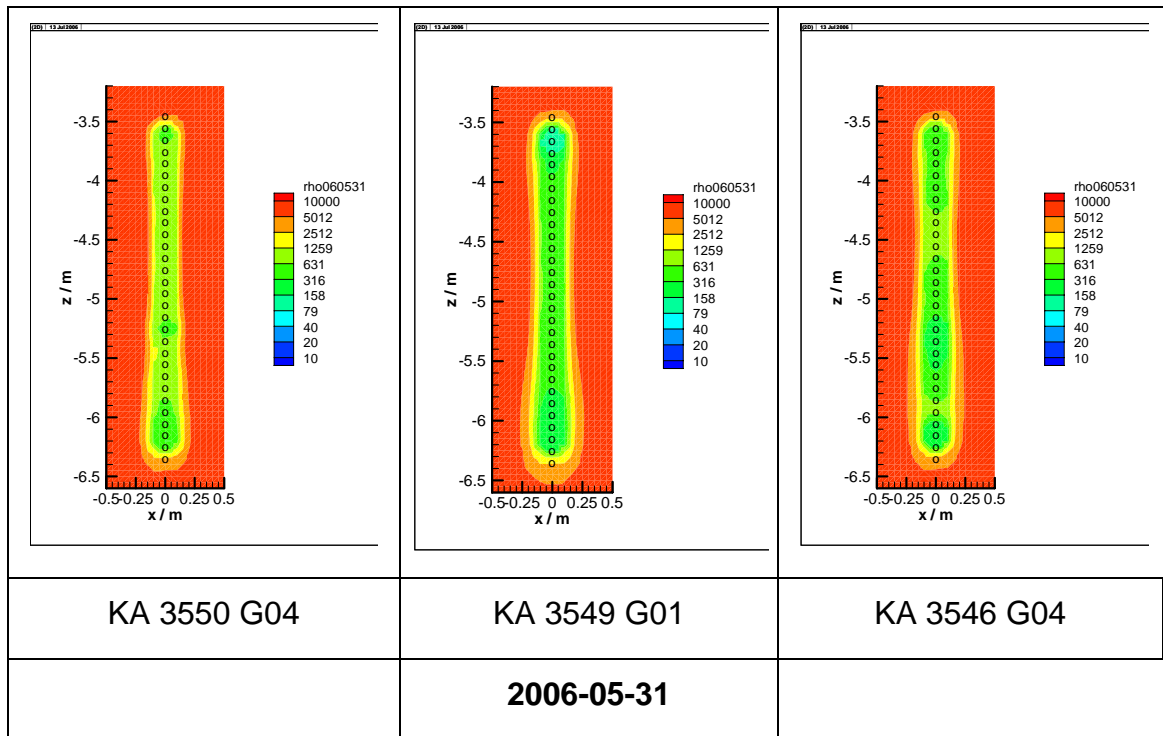












### 4.3 Actual Interpretation

The resistivity distributions along the three electrode chains installed in the rock are quite similar to each other and show no significant variation in time until April 2003. Close to the electrodes, the resistivity ranges around 200  $\Omega\text{m}$ . This value characterizes the water-saturated concrete used for backfilling the electrode boreholes. Further away from the boreholes, the resistivity rises to values of 2000 to 7000  $\Omega\text{m}$  which is characteristic for water-saturated granite.

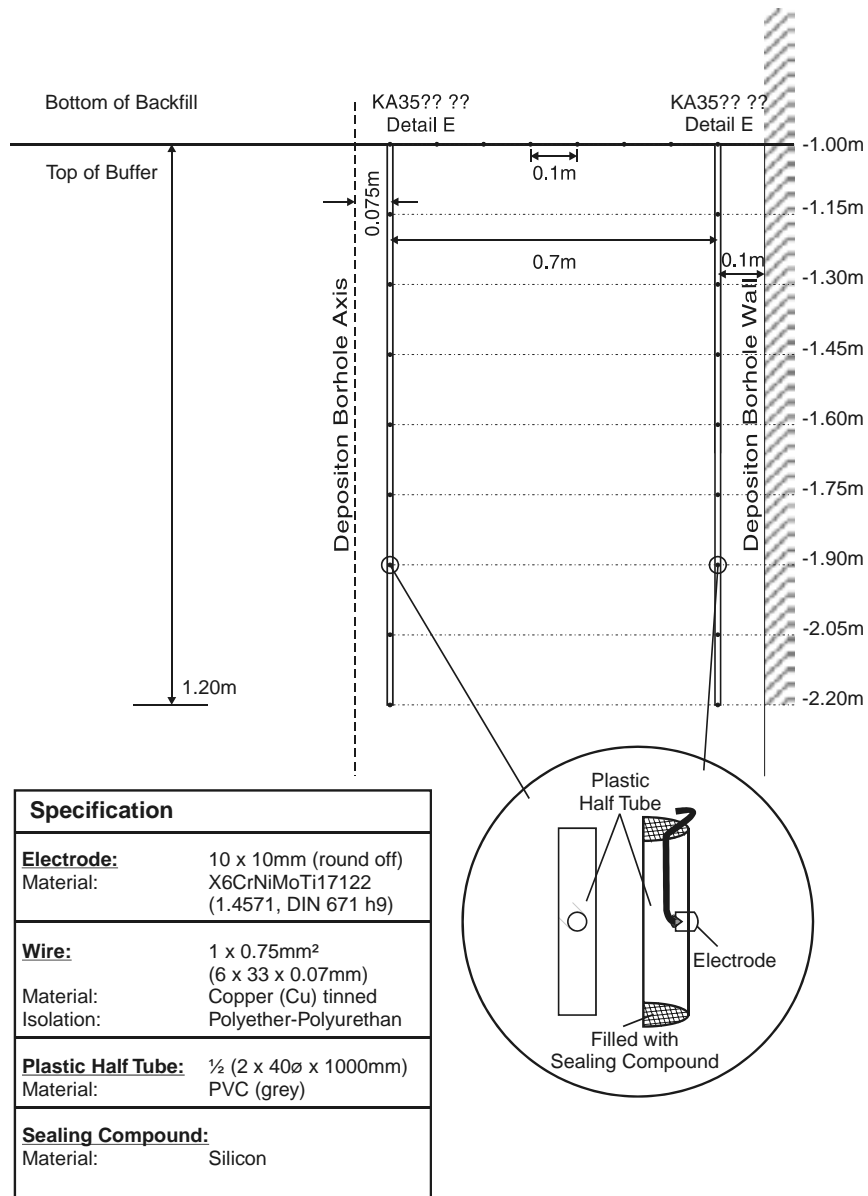
From April 2003 on, there is a slight decrease in resistivity in the rock near deposition hole #5. This coincides with installation of the buffer which also stopped the pumping of water from the open deposition hole. Apparently, this had caused a slight desaturation of the rock which recovered. From February 2004, resistivity seems to slightly increase again. Near the deposition hole #6, no such effect was detected.



## 5 Buffer in Borehole 5 in Section 2

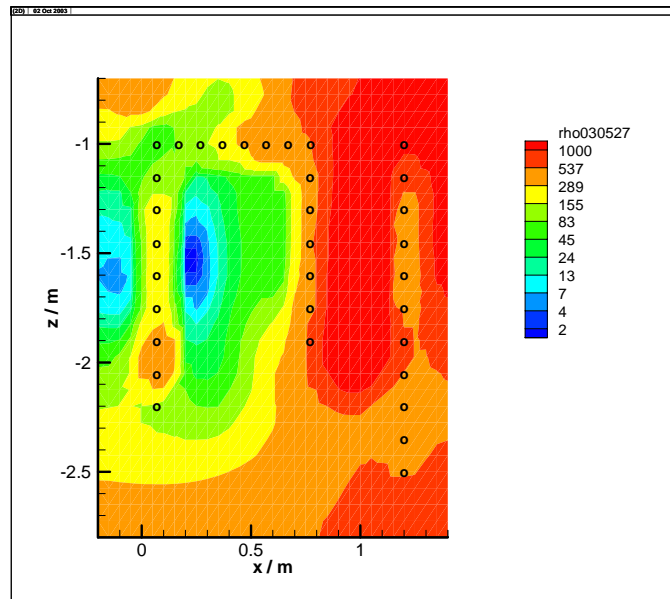
### 5.1 Layout of electrode array in the buffer of deposition boreholes 5

The array is made up of the electrodes located in the buffer at the top of deposition hole #5 (see figure) and of the electrodes in the upper part of borehole KA 3550 G04 in the rock (see figure in section 4.1).

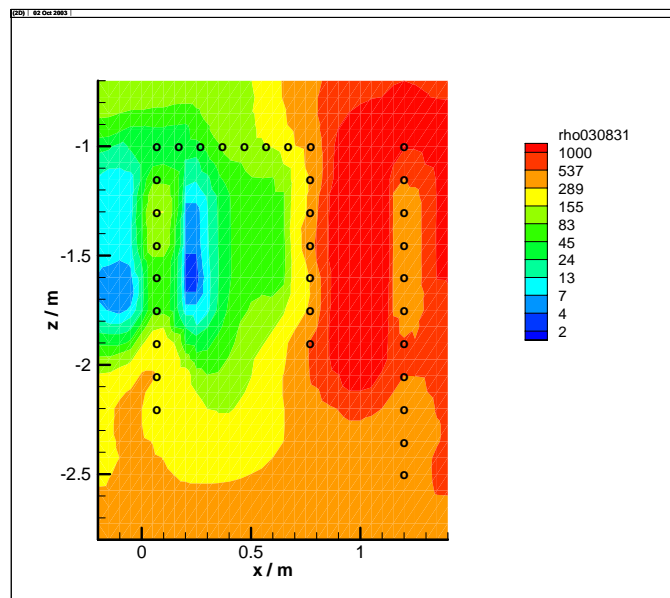


ELECTRODE DETAIL E VERS.01.CDR

## 5.2 Tomograms of electrode array in the buffer

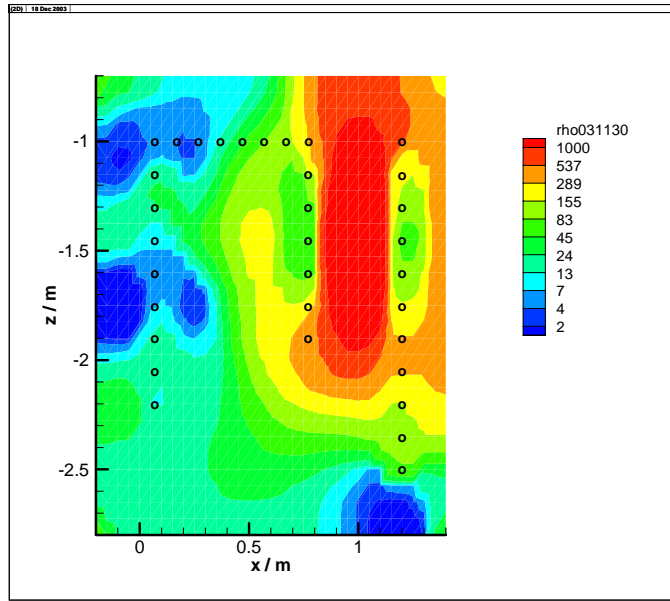


2003-05-27

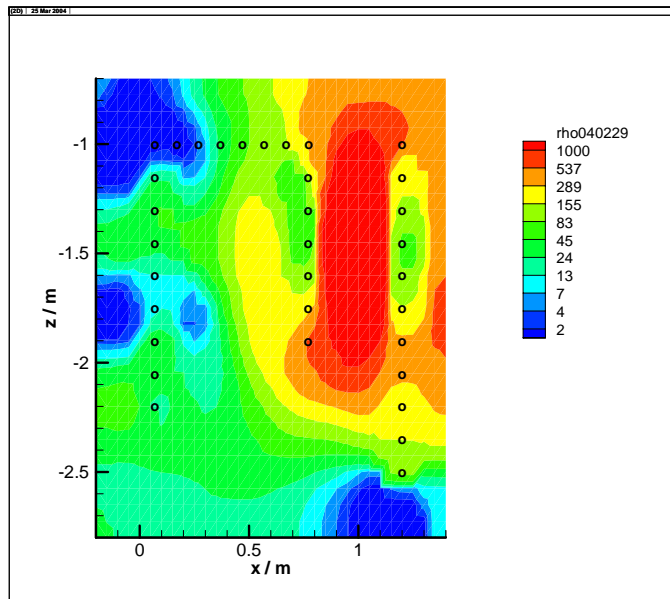


2003-08-31

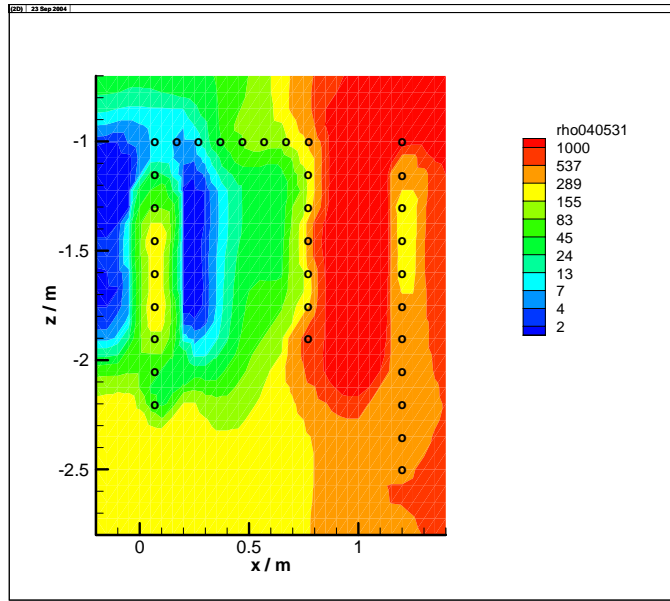




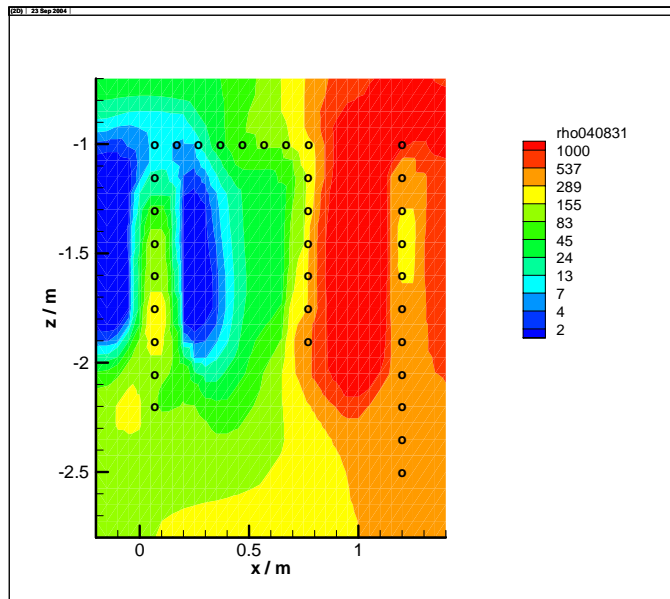
2003-11-30



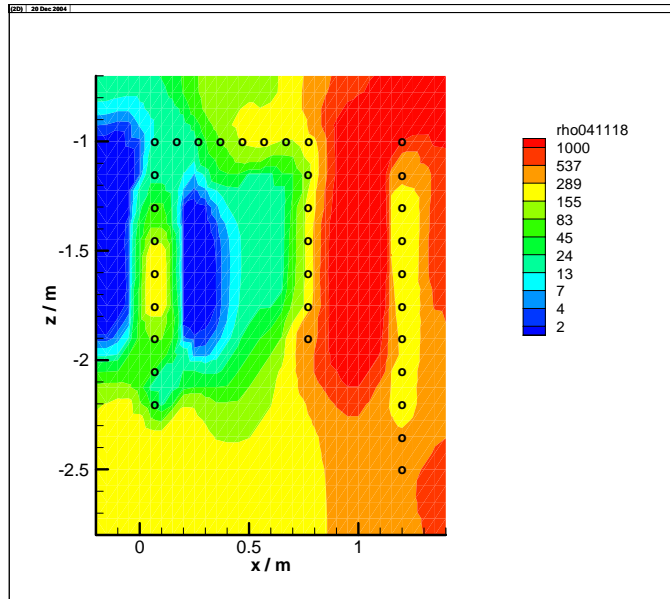
2004-02-29



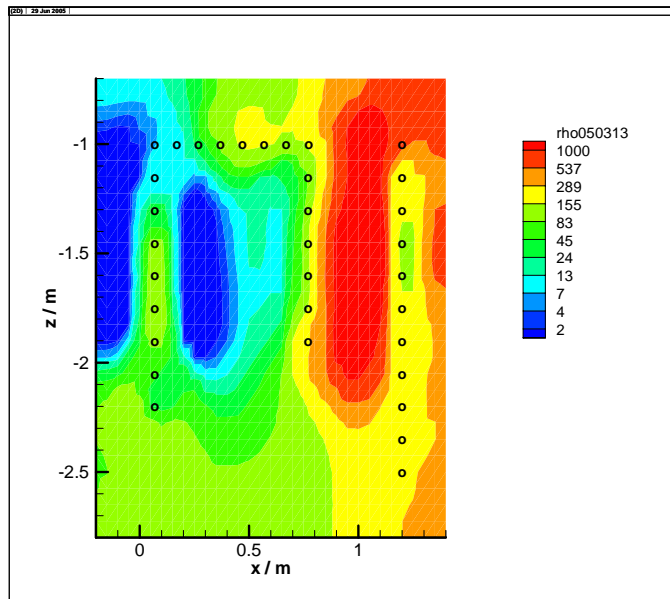
2004-05-31



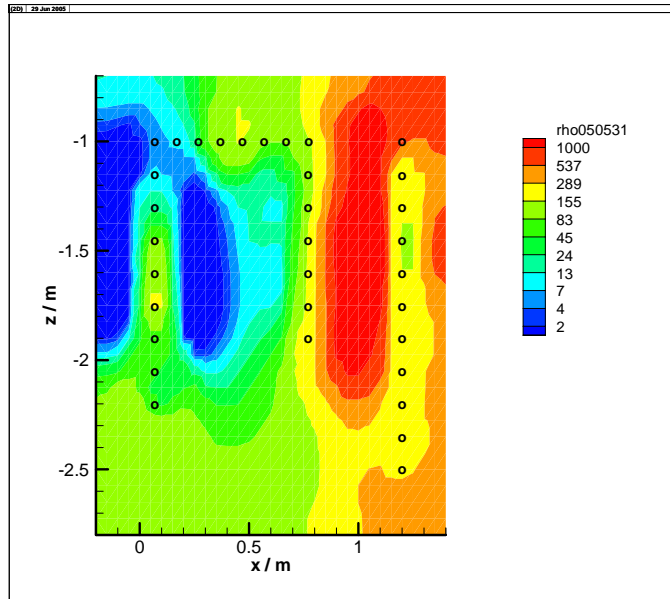
2004-08-31



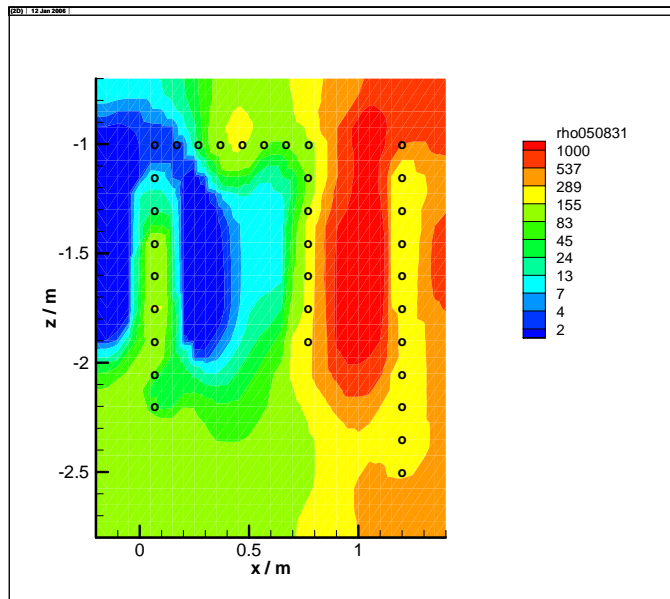
2004-11-18



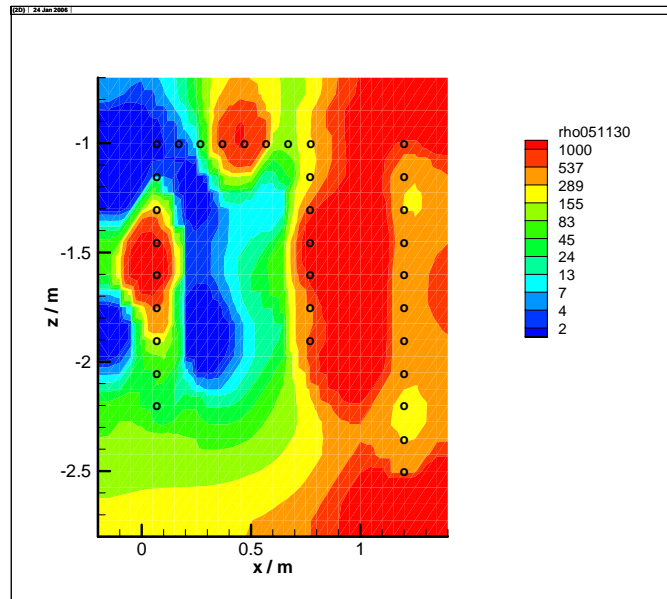
2005-03-13



2005-05-31



2005-08-31



2005-11-30

### 5.3 Actual Interpretation

The tomogram of May 2003 (first measurement) shows the high resistivity (above 1000  $\Omega\text{m}$ ) of the rock on the right side and the low resistivity of the buffer (below 80  $\Omega\text{m}$ ). The picture is somewhat distorted by the fact that along the electrode chains the resistivity is increased compared to the undisturbed buffer. The increased resistivity along the electrode chains can be attributed to the refilling of the electrode boreholes with bentonite powder produced during borehole drilling. It was, however, expected that the difference will diminish with time, especially if the buffer takes up water. The tomograms of the following months show a progressing decrease of resistivity in the buffer. While the overall behaviour is rather clear, it is difficult to interpret buffer resistivity in terms of water content. In nearly all the buffer monitored by the array the resistivity has decreased to values below 24  $\Omega\text{m}$  by November 2004 and below 13  $\Omega\text{m}$  by end of May 2005. The tomogram of November 2005 shows two high resistivity anomalies in the buffer. These are not real, but result from the fact that two electrodes have been lost between September and November, 2005. The accuracy of the results is reduced by the loss of electrodes. From November 2005 on, more electrodes failed (possibly due to corrosion) so that a tomographic evaluation was no longer possible. The injection current of the electrode pairs which are still working is still increasing, which is a hint to a further decrease in resistivity, meaning the buffer is still taking up water.



## **Appendix 10**

### **Stress and strain in the rock**





# **BBK**

## **STRESS AND STRAIN MEASUREMENT OF THE ROCK MASS PROTOTYPE TEST AT ÄSPÖ**

Measuring period

2005-12-01 – 2006-05-31

Martin Edelman

Kennert Röshoff

2006-07-19

---

BergByggKonsult AB Ankdammsgatan 20 171 43, Solna, Sweden

Tel. 08-7595050 Fax. 08-7595065



# 1 Extent

BBK AB and NCC Teknik have, on commission of SKB, ÄSPÖ Hard Rock Laboratory, performed rock mechanical measurements in the Prototype tunnel at Äspö. The measurement program comprises registration of the stress and strain response around the two deposition holes during drilling and heating of the rock mass.

In the first phase, the response of the rock mass was monitored during the drilling of the two canister holes. The second phase, which is the subject of this report, includes the response registered during a heating phase. The heating experiment started on 2003-05-08 and will continue for about five years.

The goal of the instrumentation is to monitor the stress, strain and deformation changes due to heating of the rock mass surrounding the deposition holes. Instrumentation has been installed to monitor the relative changes in intact rock as well as across fractures.

The commission extends over field measurement and evaluation.

BBK AB is responsible for measuring equipment, the mobilization, field measurement, the computer processing. BBK AB and NCC Teknik are responsible for the interpretation and reporting of the measurements.

This report presents the measurement results during the period of the heating phase from 2005-12-01 to 2006-05-31.



## 2 Technical background

### 2.1 Summary of instruments installed

The instrumentation for monitoring rock mechanical response was installed in two stages. The instruments used to monitor the drilling phase of the canister boreholes were installed within vertically drilled boreholes located 0.3m from the periphery of the deposition hole. These instruments are referred to as primary instruments in the following section. Following drilling of the deposition holes, complementary instruments were then installed within boreholes drilled from within the deposition holes.

The following numbers and types of instruments were selected for installation to allow monitoring of stresses and strains within the host rock surrounding the deposition holes.

**Table 2.1. Summary of primary instruments**

Parameter measured	Instrument type	Total number installed
Compressive stress change in intact rock	Geokon model 4350 biaxial stressmeter	8
Compressive and tensile stress change in intact rock	Geokon model 4360-1 Soft stress cell	8
Vertical movements in intact rock, over single fractures and within fracture zones	Geokon model 4430 deformation meter	17
Vertical strain measurements in intact rock and over single fractures	Geokon model 4200 strain gauge	7

**Table 2.2. Summary of complementary instruments**

Parameter measured	Instrument type	Total number installed
Horizontal deformation perpendicular to the axis of the deposition hole	Geokon model 4430 displacement transducer	32
Vertical strains beneath the deposition hole	Geokon model 4200 strain gauge	8

The layout of the primary instruments around the deposition holes is shown in Figures 2.1 and 2.2. A total of eight 60mm diameter boreholes (four around each of the two deposition holes) were drilled. The majority of the instruments were installed within these boreholes. These holes are designated as A, C, E and G- 5 and 6. In addition, a total of four 76mm diameter boreholes (two at each deposition hole) were drilled to shallower depths to allow installation of the soft stress cell meters. These larger diameter holes are designated as H and D-5 and 6.

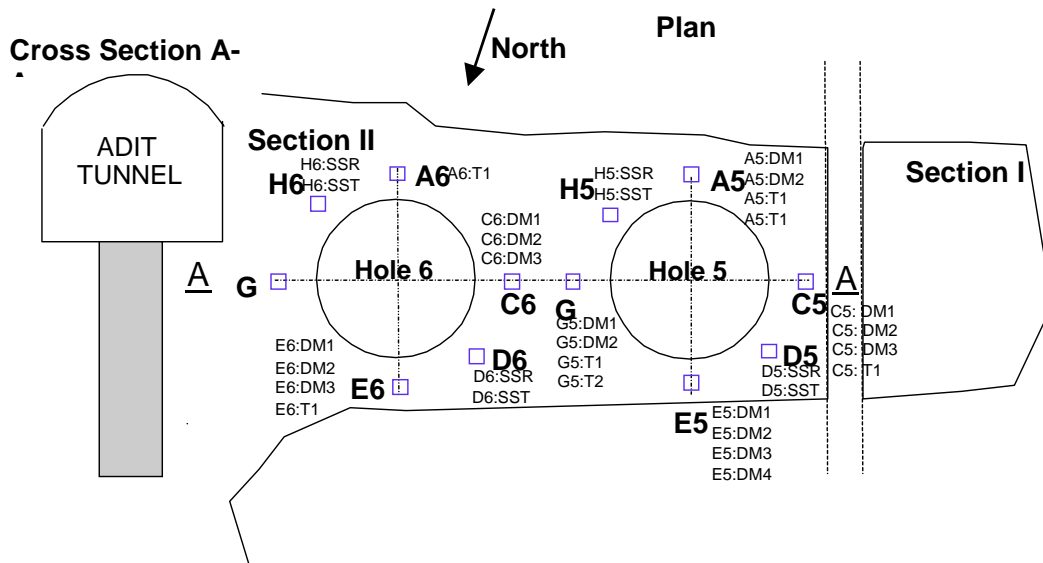


Figure 2.1 Primary instrument locations in plan view

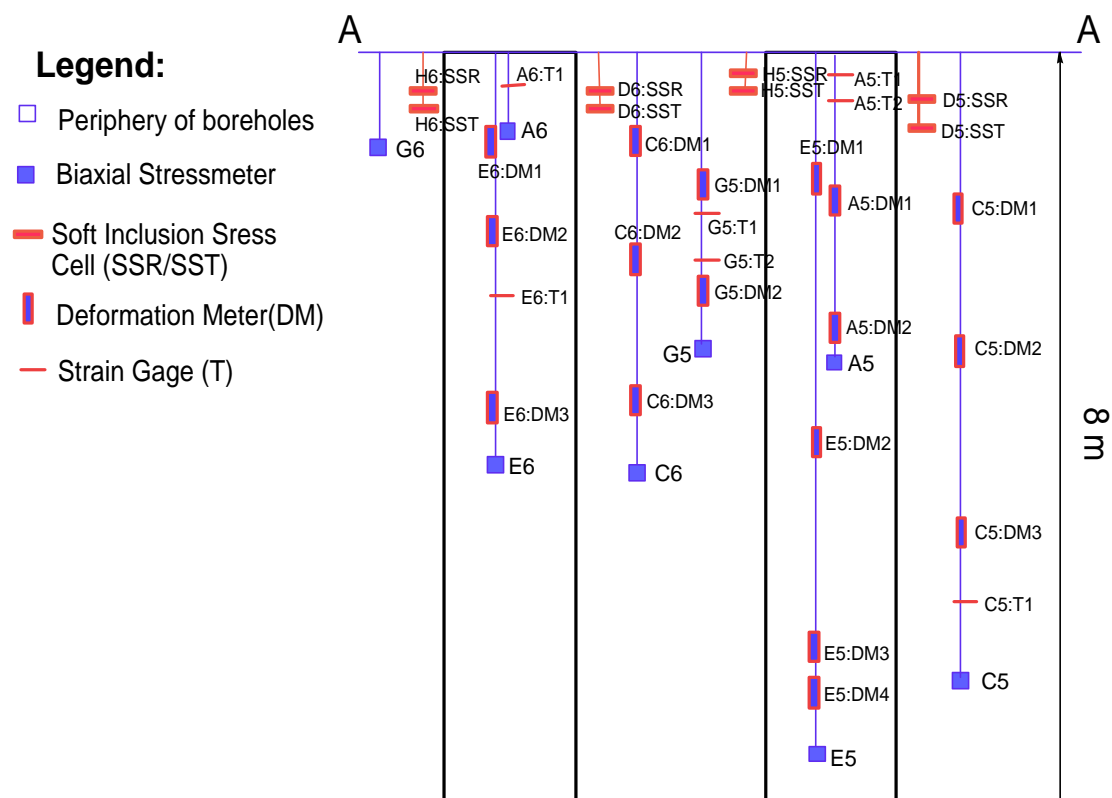
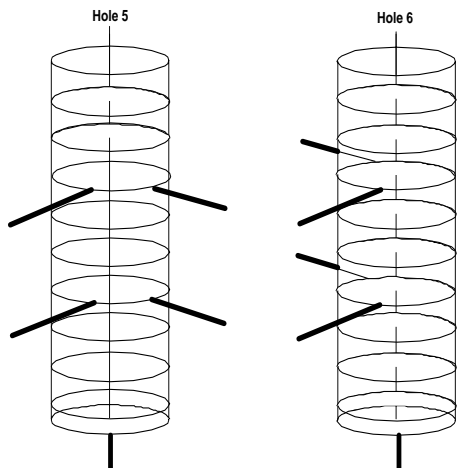
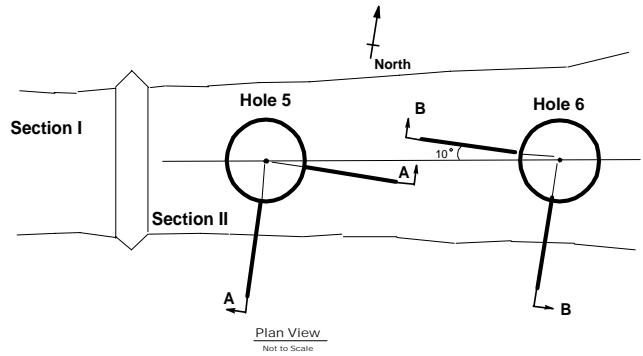


Figure 2.2 Primary instrument locations in elevation view

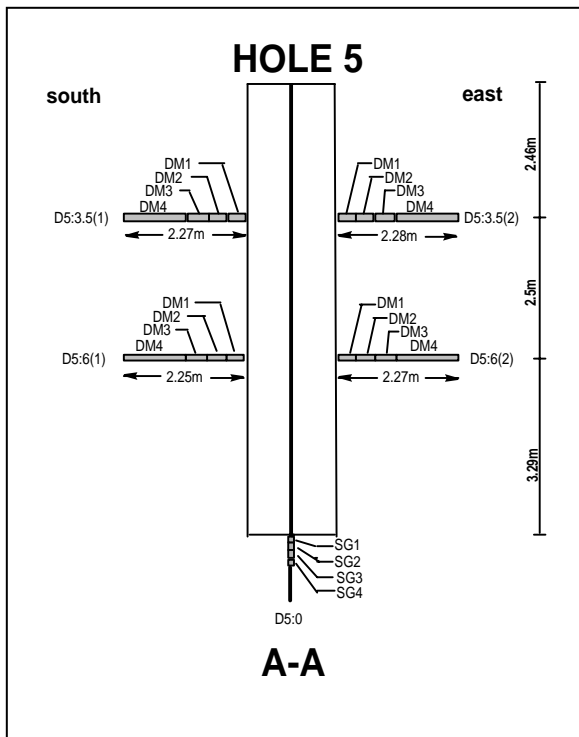
Installation of the complementary instruments took place following drilling of ten boreholes having about a 75mm diameter from within the two deposition boreholes. The locations of these ten boreholes are shown schematically as well as in plan and elevation in Figures 2.3 to 2.6. The instruments installed within these boreholes consisted of displacement transducers ranging in length from 0.3m to 1.2m, and strain gauges which were 0.15m in length.



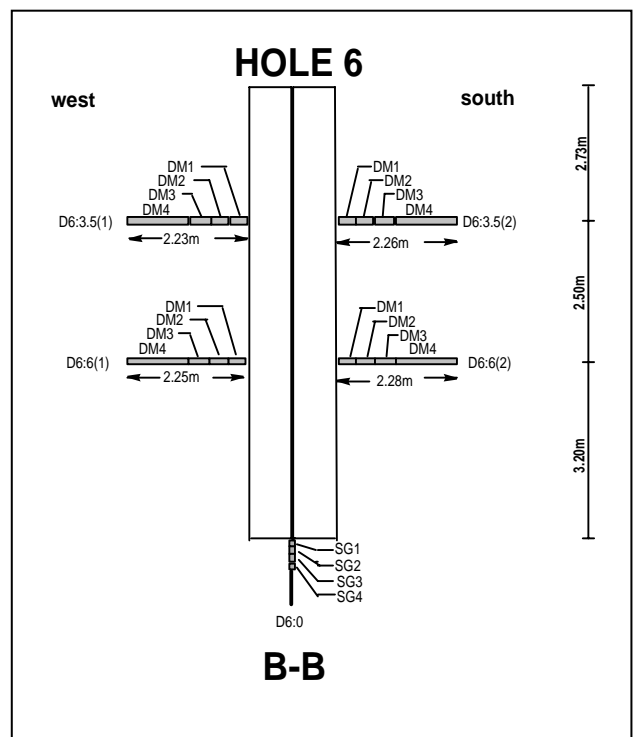
**Figure 2.3** Schematic view of complementary boreholes



**Figure 2.4** Plan view of complementary boreholes



**Figure 2.5** Elevation view of complementary instruments in Deposition Hole 5

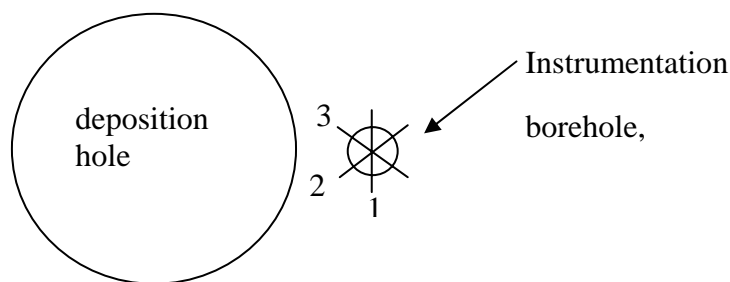


**Figure 2.6** Elevation view of complementary instruments in Deposition Hole 6

## 2.2 Stress measurements

### 2.2.1 Vibrating wire embedment biaxial stressmeters

The Geokon model 4350 vibrating wire biaxial stressmeter was installed for monitoring stress changes. This instrument was designed to measure compressive stress changes in rock, salt, concrete or ice. The instrument consists of a stiff high-strength steel cylinder, which is grouted into a BX (60 mm) size borehole. Stress changes in the host material cause the cylinder to deform, and the deformations in the plane perpendicular to the borehole are measured by means of two sets of three vibrating wire sensors spaced at  $60^\circ$  intervals (measurements are made at two levels within the cylinder). The gauges also include two longitudinal strain sensors and temperature sensors. The deformation of the steel cylinder, and resulting changes in resonate frequency of the vibrating wires, are used to determine both the magnitude and orientation of the change in stress in the host material.



Installation of the stressmeter gage is accomplished by inserting the gage into a grout-filled borehole using a setting tool and self-aligning setting rod. The stress cell is orientated so that the first vibrating wire is orientated tangentially to the canister hole. The second wire is orientated  $60^\circ$  from tangential direction and the third wire is orientated  $120^\circ$  from tangential direction.

### 2.2.2 Vibrating wire soft inclusion stress cell

The Geokon model 4360 soft inclusion stress cell is designed to measure changes in borehole diameters caused by changes in stress in rock and concrete. In use, an instrumented steel ring is installed in a borehole and pre-stressed in place by forcing platens into contact with the borehole walls. A vibrating wire strain gage measures the deformation of the ring, which is also the deformation of the borehole. Both compressive and tensile measurements can be made. Unlike the biaxial stressmeters that contain sets of 3 vibrating wires, the soft stress cells measure deformation changes in only one direction. For this reason the soft stress cells are installed in pairs to measure stress changes tangential and radial to the deposition holes.



## **2.3 Deformation gages**

Deformations around the deposition holes are measured with deformation gages installed both within the same boreholes used for the biaxial stressmeters, as well as in the horizontal complementary boreholes.

The Geokon model 4430 Deformation gage is designed to measure longitudinal deformations in boreholes. The deformation meter consists of a tube with an anchor at each end. Within the tube a beam of graphite will transfer any distance changes between the two anchors to a vibrating wire sensor. In each deformation meter a temperature sensor is included for temperature corrections.

## **2.4 Embedded strain gages**

At some particular locations, Geokon model 4200 strain gages have been installed over single fractures. This model gauge is designed for direct embedment in cast concrete and for installation in grouted boreholes. A steel wire is tensioned between two end blocks and the strain of the wire is measured using the vibrating wire principle. Deformations in the rock mass induced movements of the hard cement causing the two end blocks to move in relation to each other across a joint, thereby altering the tension in the wire. The tension in the wire is measured by plucking the wire and measuring its resonant frequency of vibration using an electromagnetic coil.

## **2.5 Cement**

Special expansive grout was used to insure that the gage is in complete contact with the surrounding rock. The instruments are grouted in special cement from Denmark named Densitop T2. This cement is chosen to have as similar properties as the rock as possible. The compression strength is 150 Mpa. The coefficient of expansion is approximate 8.5 microstrain/C° that is similar to hard rock as granite and as 85 % of common concrete.

## **2.6 Registration**

Two datalogger type Campbell CR10X have recorded the measurements, which have typically been recorded once every four hours during the period 2005-12-01 to 2006-05-31.



## 3 Computer processing of field data

### 3.1 Evaluation of stresses from biaxial stressmeters

The stress changes are evaluated from the measured deformations registered by the vibrating wires.

#### 3.1.1 Radial deformations

Radial deformation for each of the vibrating wires are calculated with the equation:

$$V_r = (R_1 - R_0) * \text{Gagefactor} \quad (\text{mm/ digit})$$

$V_r$  = Radial deformation for each of the vibrating wires

$R_1$  = Deformation reading in digits (= frequency<sup>2</sup> / 1000)

$R_0$  = Deformation zero reading in digits (= frequency<sup>2</sup> / 1000)

#### 3.1.2 Calculation of deformation to stresses

The magnitude and the direction of the stress changes are determined from the measured radial deformation of the sensor in three directions.

The equations below give the magnitude and the direction of the maximum stress increase and reduction in a plane perpendicular to the borehole axes:

##### Maximal stress increase

$$p = \frac{1}{2} \left[ \frac{1}{3B} \left( (2V_{r_1} - V_{r_2} - V_{r_3})^2 + 3(V_{r_2} - V_{r_3})^2 \right)^{1/2} + \frac{1}{3A} (V_{r_1} + V_{r_2} + V_{r_3}) \right]$$

$V_{r_1}$  = Radial deformation for vibrating wire 1

$V_{r_2}$  = Radial deformation for vibrating wire 2

$V_{r_3}$  = Radial deformation for vibrating wire 3

$A, B$  = Coefficients depending on the sensor geometry and the material properties

##### Maximal stress reduction

$$q = \left[ \frac{1}{3A} (V_{r_1} + V_{r_2} + V_{r_3}) - p \right]$$

### The angle of the maximal stress increase

The angle in the plane perpendicular to the borehole axes is measured clockwise from the tangential direction of the canister hole.

$$\theta = \frac{1}{2} \cos^{-1} \left[ \frac{V_{r_1} - A(p+q)}{B(p-q)} \right]$$

### **3.2 Evaluation of stress from soft inclusion stress cells**

The eight soft inclusion stress cells each contain one vibrating wire which is mounted at a 90° angle from measured direction of stress. Therefore an increase in the readings in digits indicates a reduction on borehole diameter.

The change in the diameter of the borehole is calculated as follows:

$$D = (R_1 - R_0) * G$$

Where  $R_1$  and  $R_0$  are the current and initial readings respectively, in units of digits (frequency<sup>2</sup> / 1000), and

G is the gage factor in units of (mm/digit)

### **3.3 Evaluation of deformation**

Deformation measurements taken with the Geokon Model 4430 deformation meters were calculated as temperature compensated deformation with the following equations:

$$\text{Deformation}_{\text{corr}} = ((R_1 - R_0) * C) + ((T_1 - T_0) * K) + L_c$$

Where  $R_1$  and  $R_0$  are the current and initial readings respectively, in units of digits (frequency<sup>2</sup> / 1000),

$T_1$  and  $T_0$  are the current and initial temperatures respectively in C°,

C is the gage specific calibration factor

K is the thermal coefficient based on the following equation:

$$K = ((R_1 * M) + B) * C$$

$$\text{Where } M = 0.000295, \text{ and } B = 1.724$$

$L_c$  is the gage length correction based on the following equation:

$$L_c = (17.3 * 10^{-6}) * (\text{Length of the deformation meter} - \text{transducer length}) * (T_1 - T_0)$$

For the gages installed at the Prototype project the transducer length is 267 mm

### 3.4 Evaluation of strain

Strain measurements taken with the Geokon Model 4200 gages were calculated as temperature compensated strain with the following equation:

$$\mu\mathcal{E}_{true} = (R_1 - R_0) * GF * B + (T_1 - T_0)(C_1 - C_2)$$

$\mu\mathcal{E}_{true}$  = temperature compensated microstrain

$R_1$  and  $R_0$  = Digits reading

$GF$  = theoretical gage factor

$B$  = batch calibration factor

$C_1$  and  $C_2$  are the coefficients of expansion of steel and concrete, 12.2 microstrain/ C° and 8.5 microstrain/C°.

### 3.5 Material parameters

Material parameters used in the calculations are as the following:

- Young's modulus of intact rock 69 Gpa
- Poisson's ratio of intact rock 0.25
- Coefficients of expansion of steel 12.2 microstrain/ C°
- Coefficients of expansion of concrete 8.5 microstrain/C°

### 3.6 Processing

The raw data which have been collected using Multilogger software have been processed using Microsoft Excel software.



## 4 Results

### 4.1 Overview and comments

The measurement results are presented graphically for each of the sensors in the following sections for the primary and complementary instruments.

The increase in temperature that was noted for the end of the last period can still be seen in the beginning of this period, especially for the sensors around deposition hole 6. There have not been any rapid or large changes in the readings and the noise have generally become less throughout this period.

It should be noted that the readings are currently uncompensated for the temperature effects.

#### 4.1.1 Biaxial stress meter results

The readings are mostly stable and there are fewer problems with noise throughout this period compared with the previous two periods.

Vibrating wire 6 (Vr6) in sensor A5 started presenting values again after about 11 months of malfunction. Vr1 in sensor A5 and Vr1 in sensor E6 have stopped giving values during the period. Vr4 in sensor C5 are unstable towards the end of the period.

There are no or very small changes in stress around canister hole 5. A few of the sensors around canister hole 6 show a tendency of increased stress with around 5 MPa. The temperature around this hole has also increased somewhat in the beginning of the period and ranges between 31 to 48 degrees C.

#### 4.1.2 Soft inclusion stress cell

There have been no stress changes for the sensors around deposition hole 5, and no or a very small stress decrease for the sensors around deposition hole 6. Generally the stress sensors are showing very steady values with almost no noise throughout the period. The temperature readings are somewhat unstable.

#### 4.1.3 Deformation measurements in vertical primary boreholes

The deformation meters display stable readings with very small changes. There are some noise towards the end of the period at G5Def\_1 and G6Def\_2. The temperature have decreased to some extent around deposition hole 5 and increased around deposition hole 6, but the changes are less than a few degrees C.

#### **4.1.4 Strain measurements in vertical primary boreholes**

The noise that appeared at the end of the last period continued throughout this period, but the tendencies of the registrations can still be seen. There are no or very small changes in strain. The temperature increased somewhat around deposition hole 6.

#### **4.1.5 Deformation measurements in D5 horizontal complementary boreholes**

In general there are small or no changes in deformation. However, sensor D5\_6\_1Def1 and D5\_6\_2Def1 show a compression of about 0.2mm. There is some noise at sensor D5\_35\_1Def1, and sensor D5\_6\_1Def1 stopped displaying values in mid April.

#### **4.1.6 Deformation measurements in D6 horizontal complementary boreholes**

These sensors are still exposed to some noise but not as much as for last period. Sensor D6\_35\_1Def4 stopped displaying readings in April after a few weeks of instability. The changes in deformation are small and in the range of 0.1mm. The temperature have increased a few degrees.

#### **4.1.7 Strain measurements in complementary boreholes**

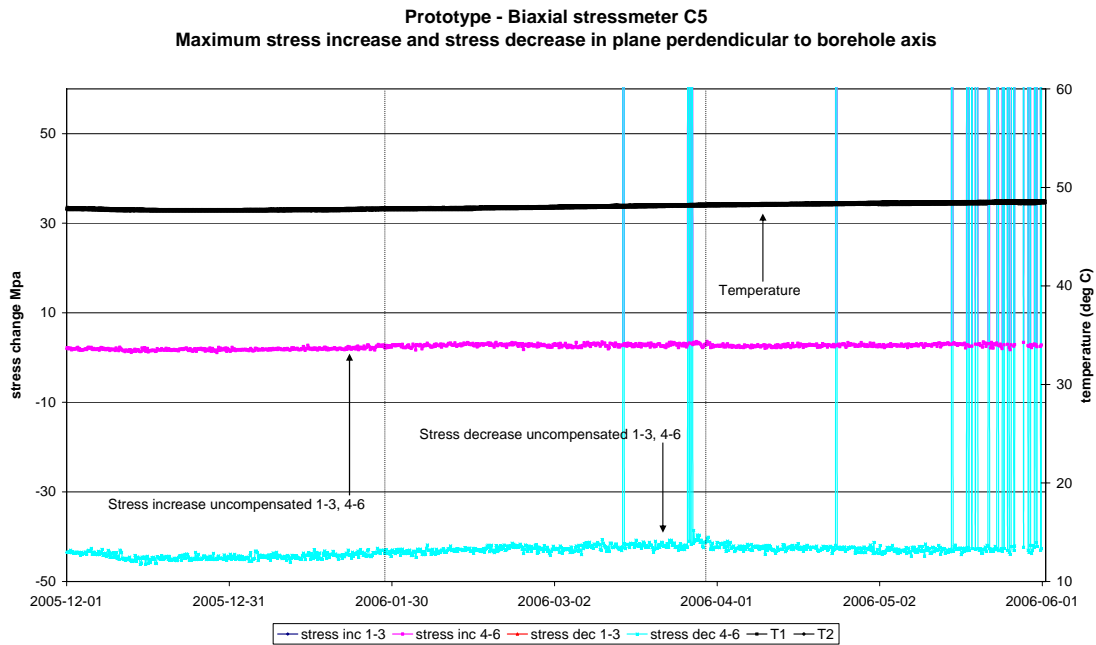
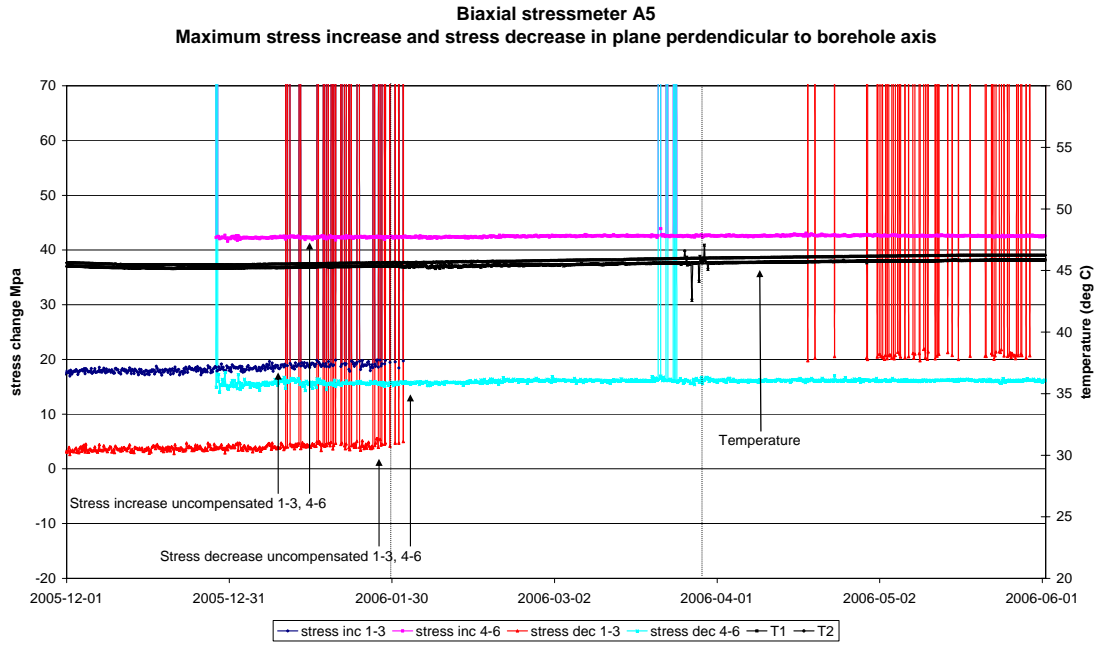
The readings from the strain gauges at deposition hole 5 are stable with small changes. D5\_0Str\_1 show a compression of 5 micro strain while D5\_0Str\_2 and D5\_0Str\_4 present a tension of 5 micro strain. The temperature is steady.

The temperature at deposition hole 6 have increased somewhat to about 45 degrees C. The strain gauges show a lot of noise but the tendencies are compressions with a maximum of 25 micro strain.

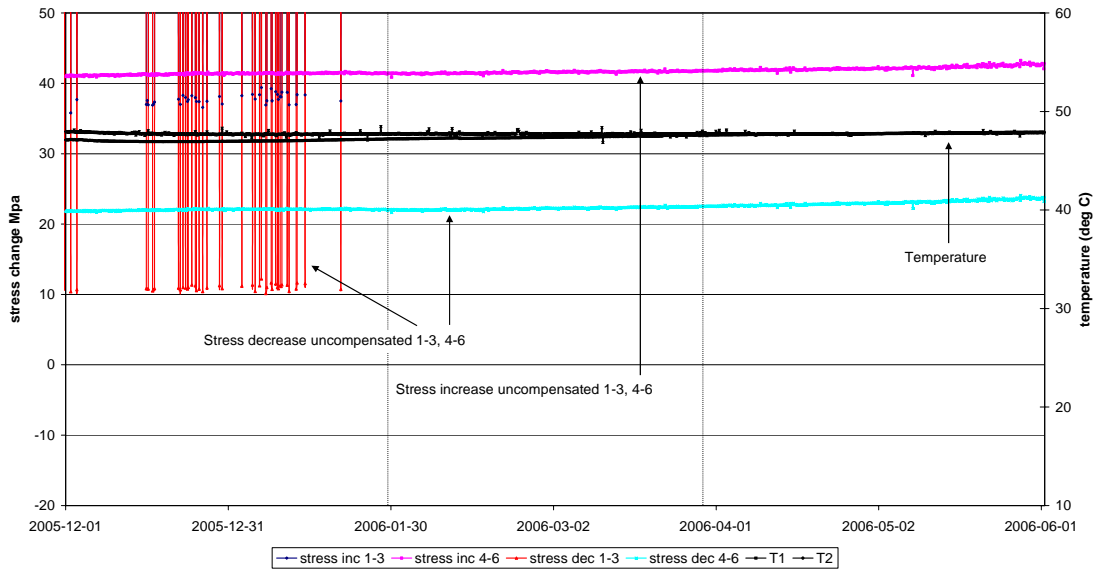


## 4.2 Graphical presentation of results

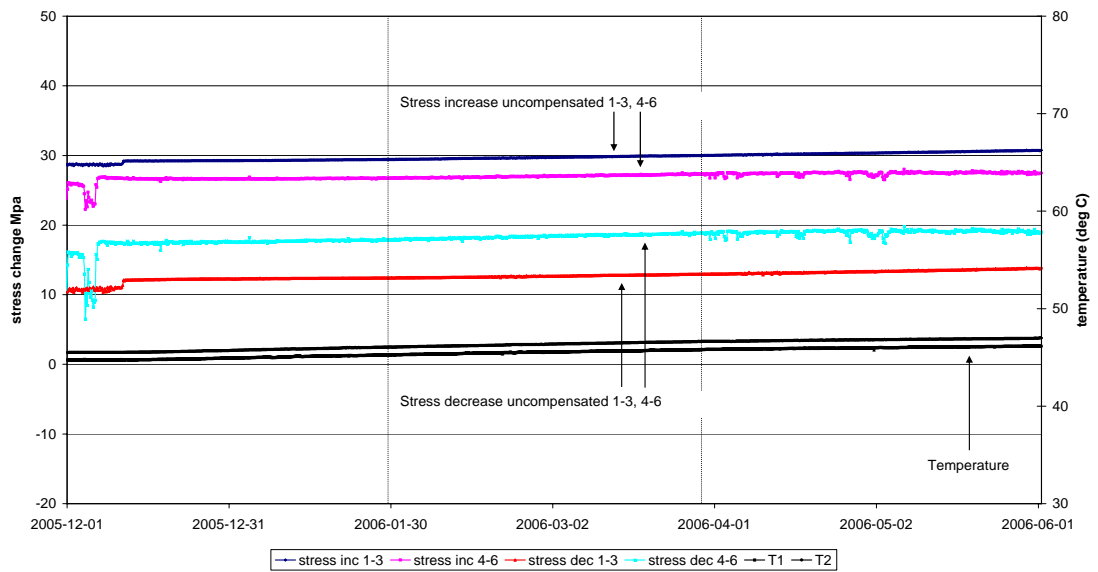
### 4.2.1 Biaxial Stressmeter results



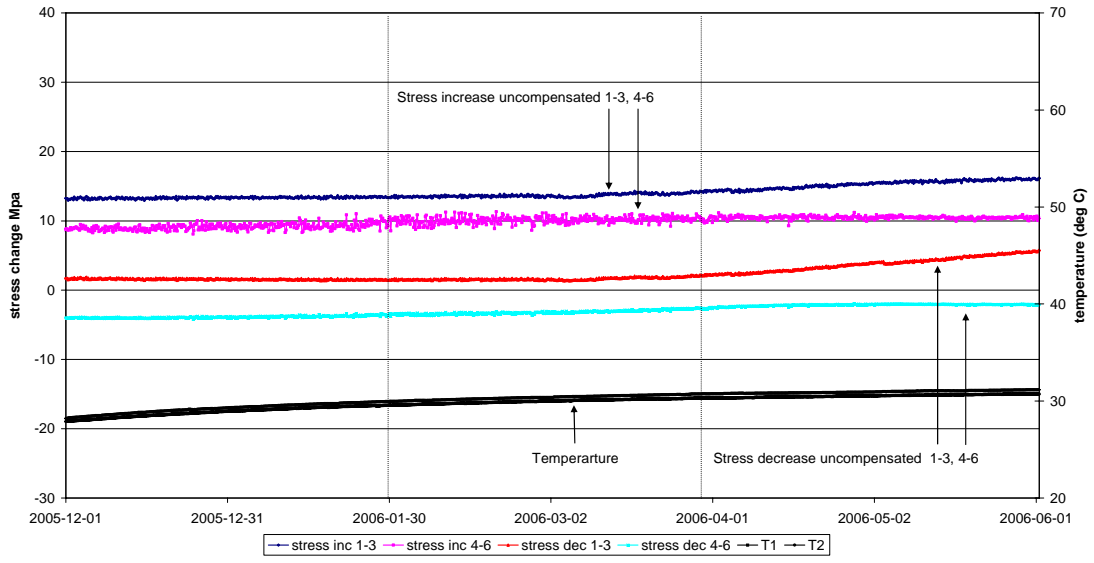
**Biaxial stressmeter E5**  
**Maximum stress increase and stress decrease in plane perpendicular to borehole axis**



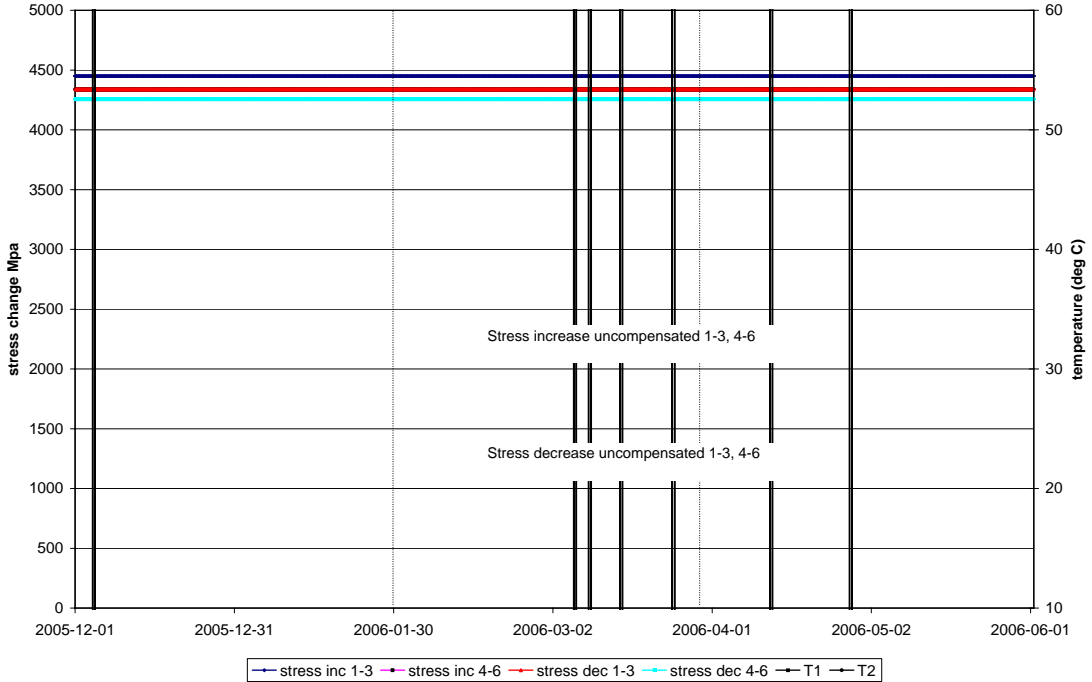
**Biaxial stressmeter G5**  
**Maximum stress increase and stress decrease in plane perpendicular to borehole axis**



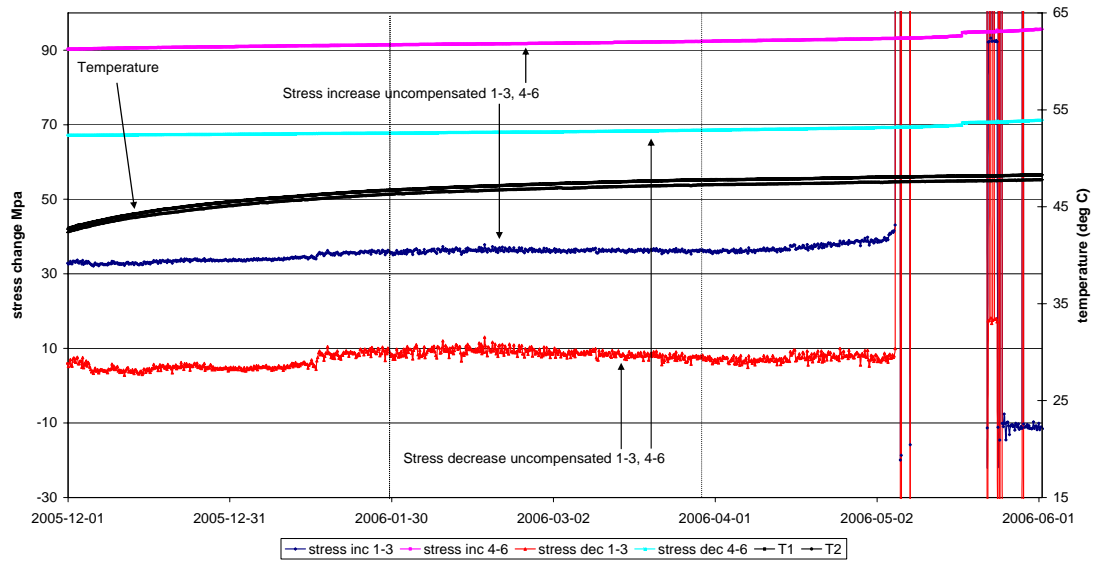
**Biaxial stressmeter A6**  
**Maximum stress increase and stress decrease in plane perpendicular to borehole axis**



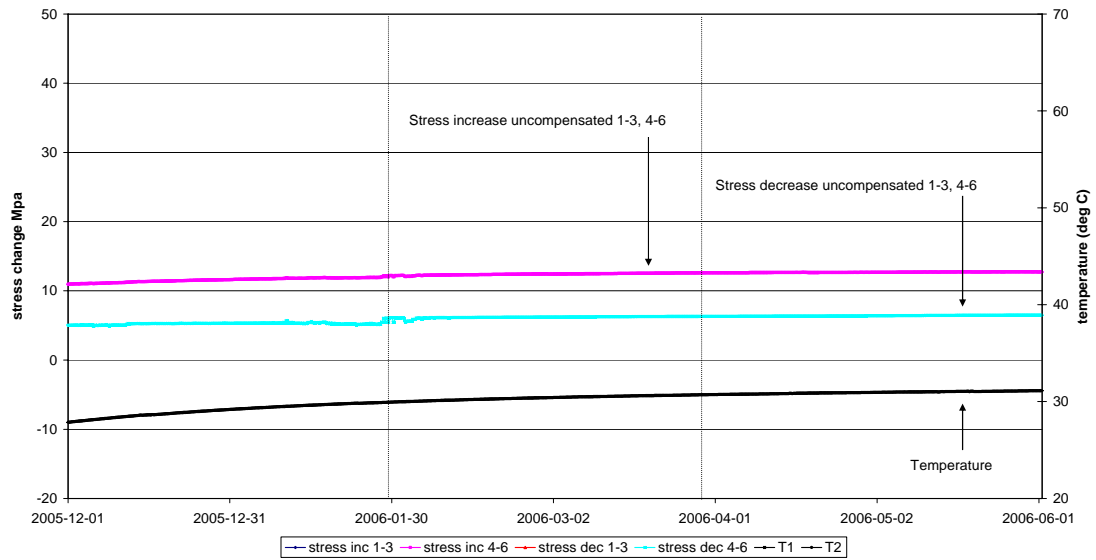
**Biaxial stressmeter C6**  
**Maximum stress increase and stress decrease in plane perpendicular to borehole axis**



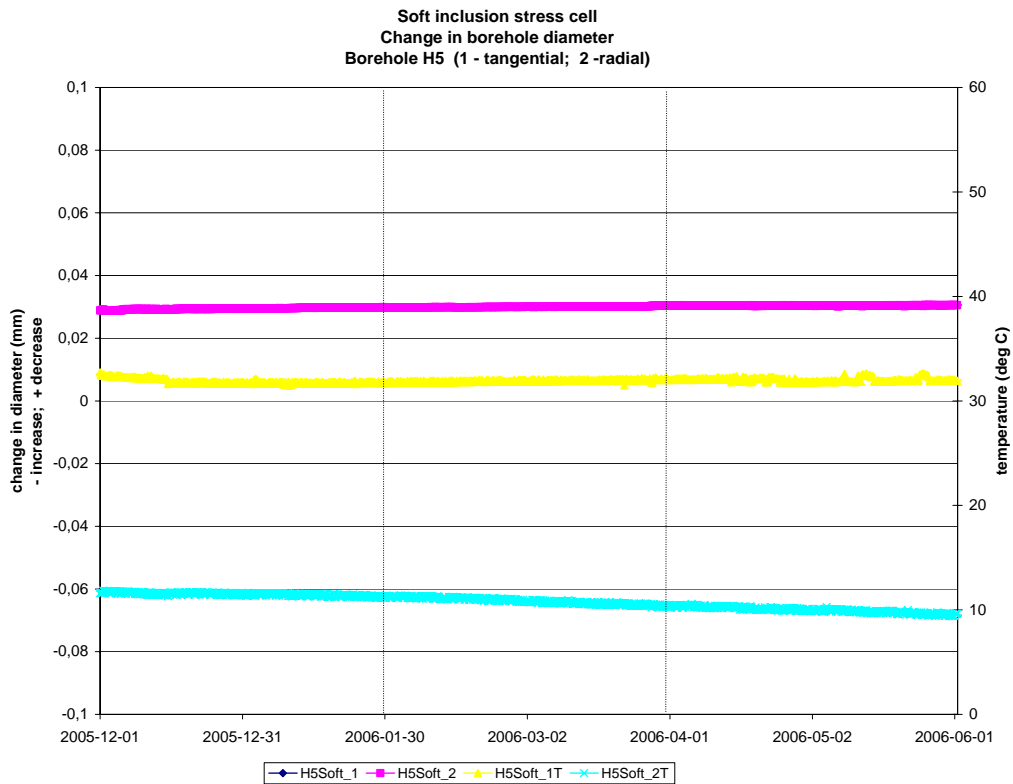
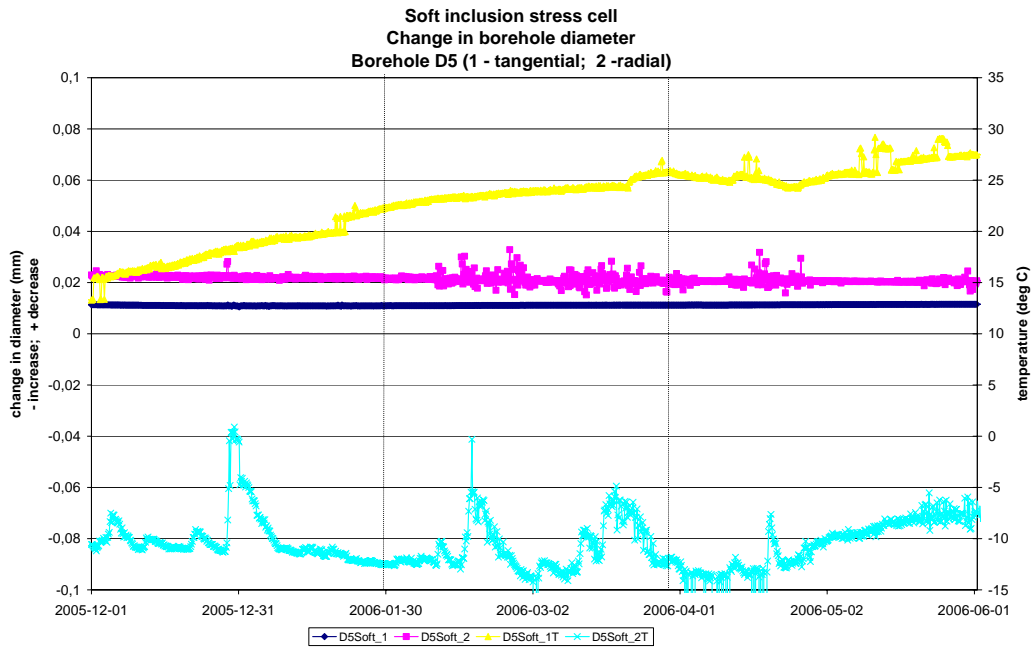
**Biaxial stressmeter E6**  
**Maximum stress increase and stress decrease in plane perpendicular to borehole axis**

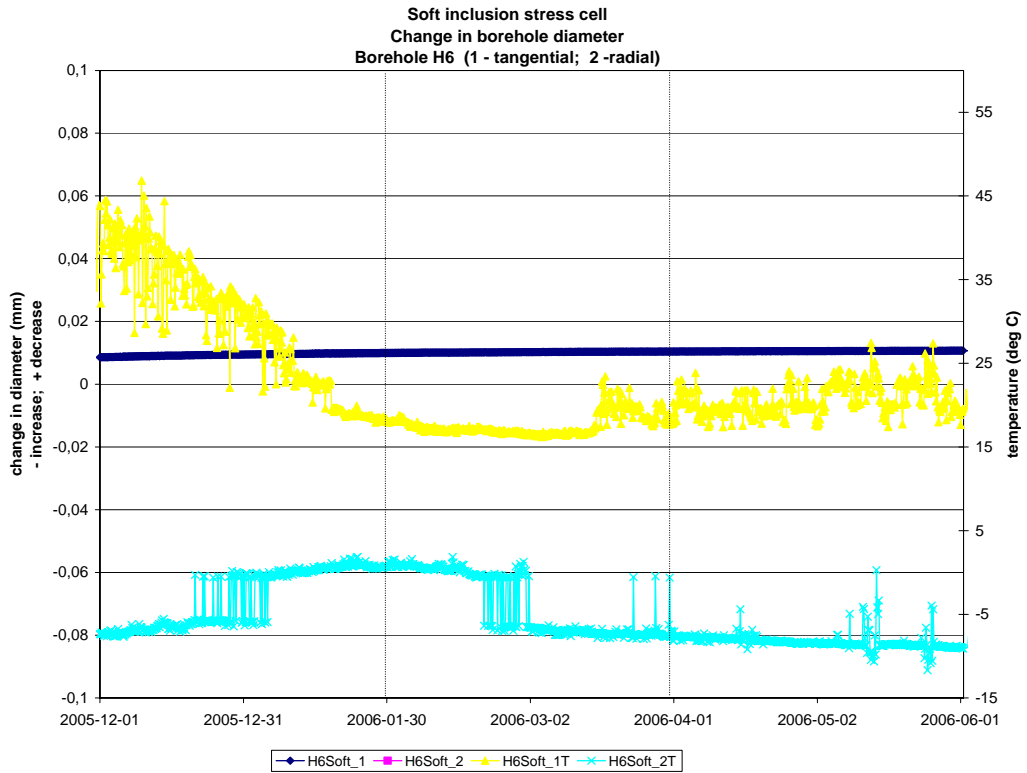
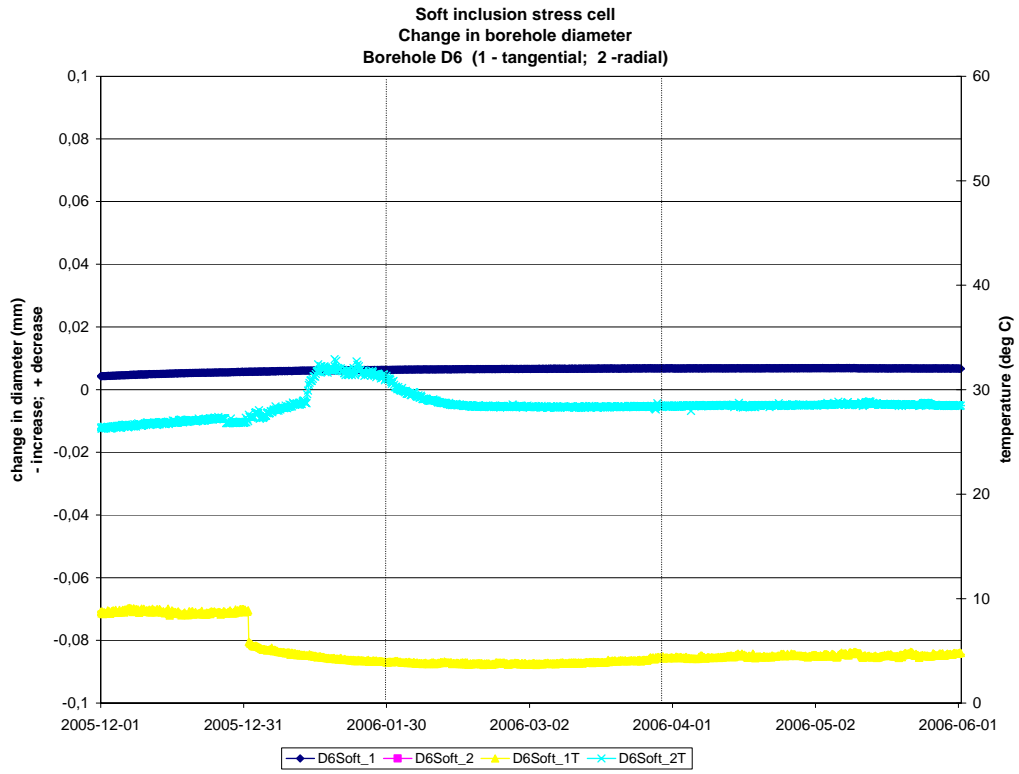


**Biaxial stressmeter G6**  
**Maximum stress increase and stress decrease in plane perpendicular to borehole axis**

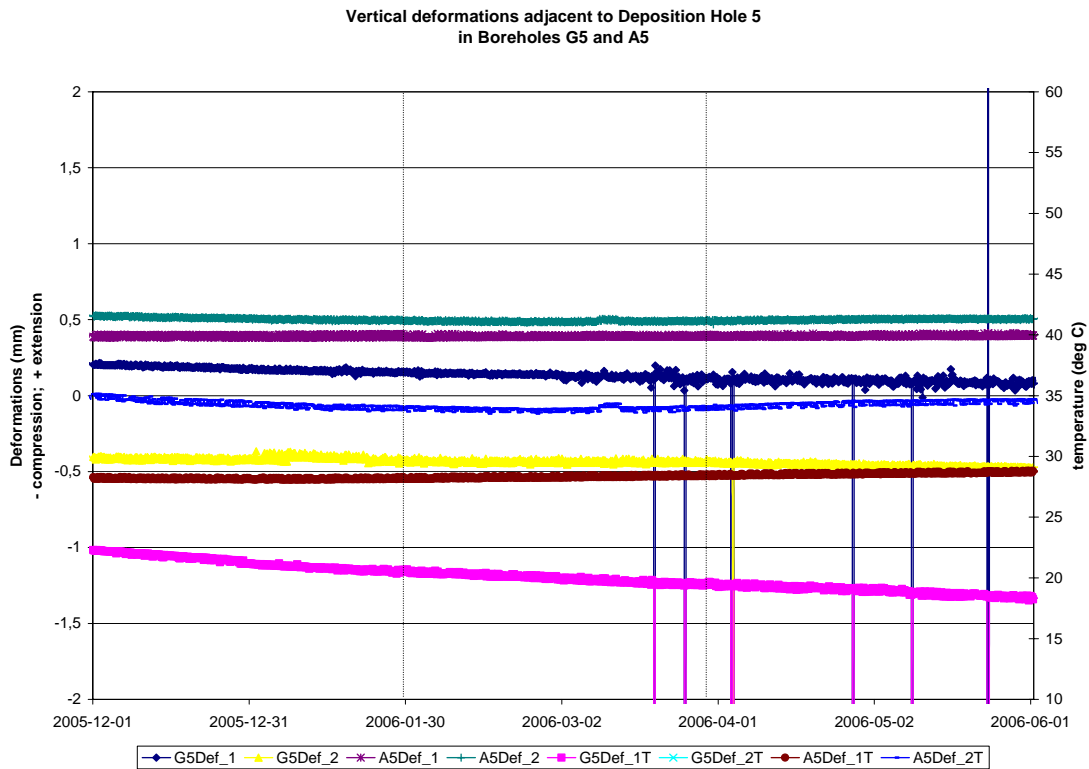
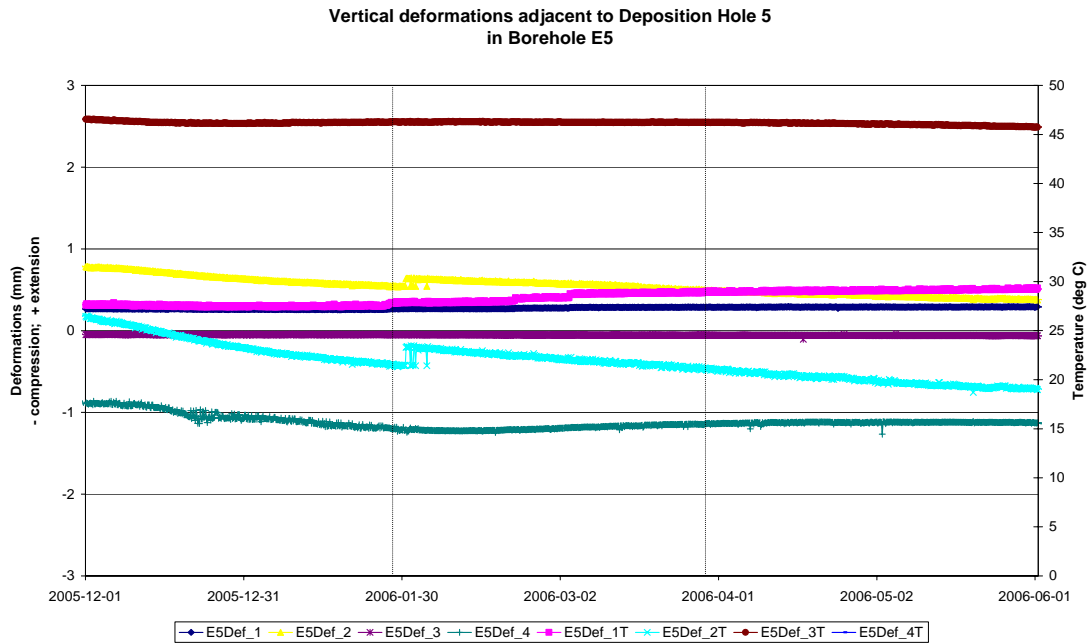


## 4.2.2 Soft inclusion stress cell results

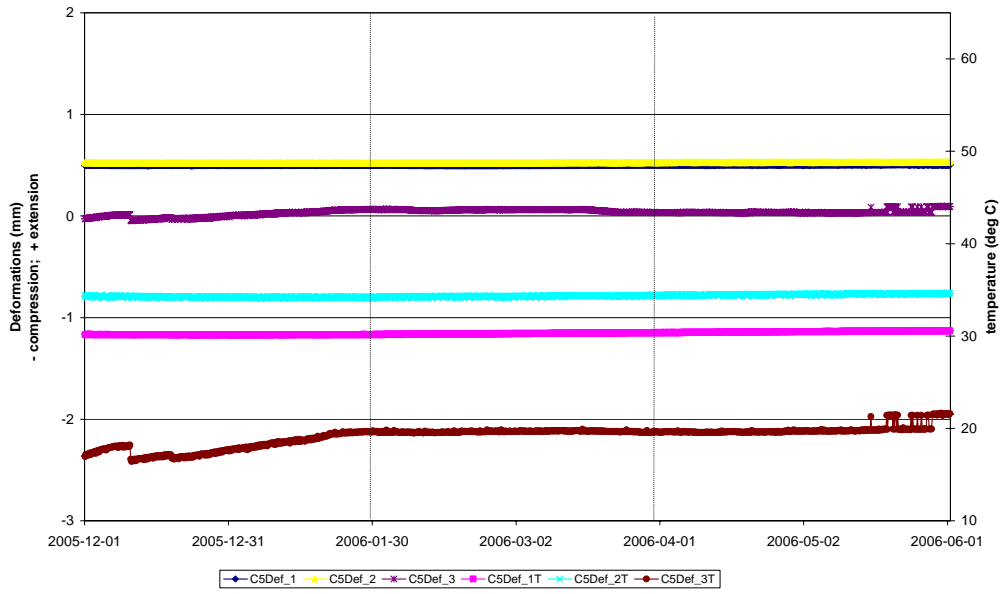




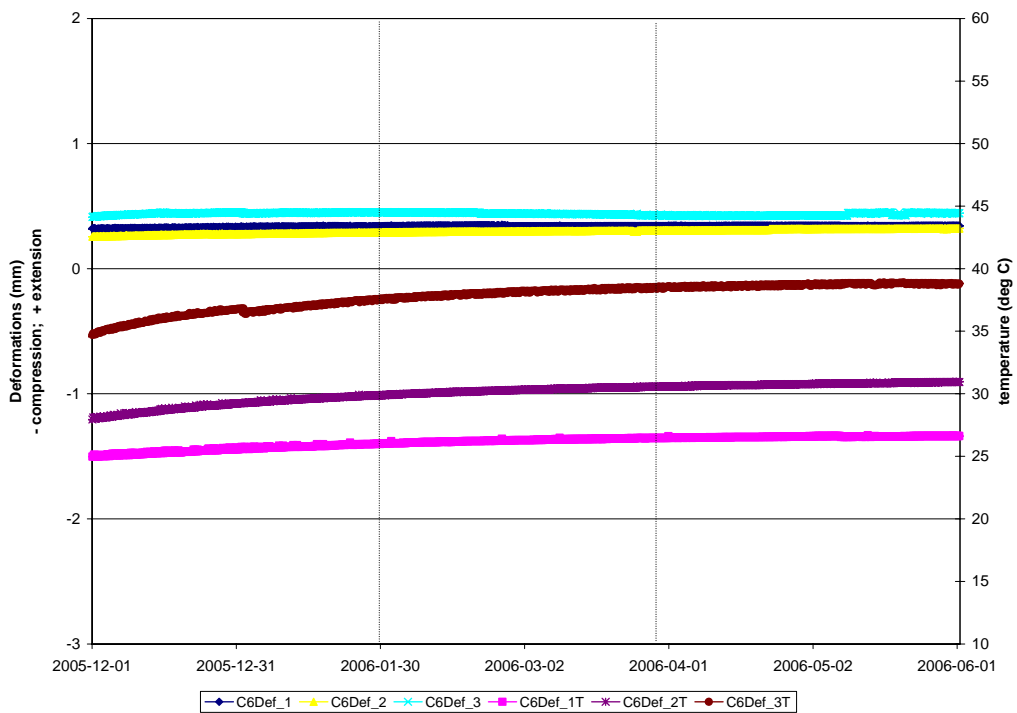
### 4.2.3 Deformation measurements in vertical primary boreholes



Vertical deformations adjacent to Deposition Hole 5  
in borehole C5

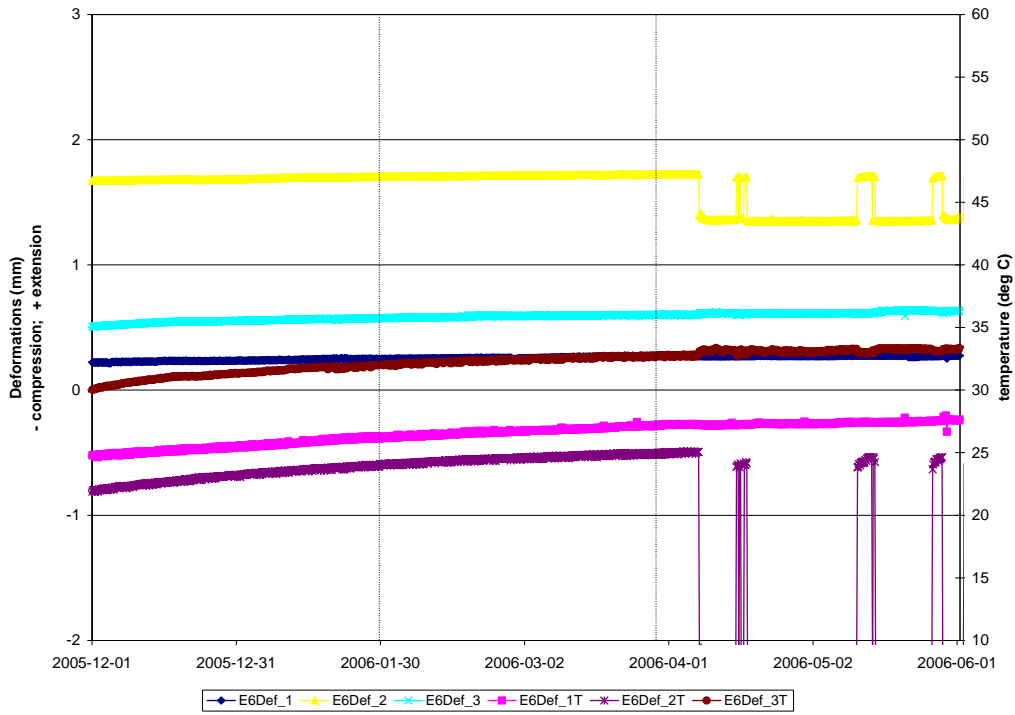


Vertical deformations adjacent to Deposition Hole 6  
in borehole C6



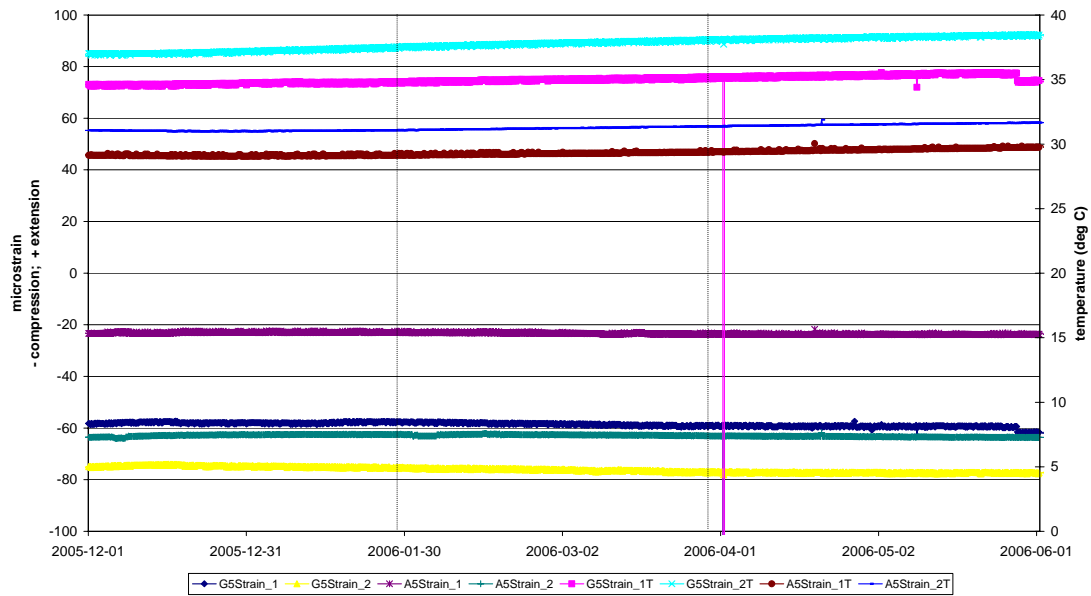


Vertical deformations adjacent to Deposition Hole 6  
in borehole E6

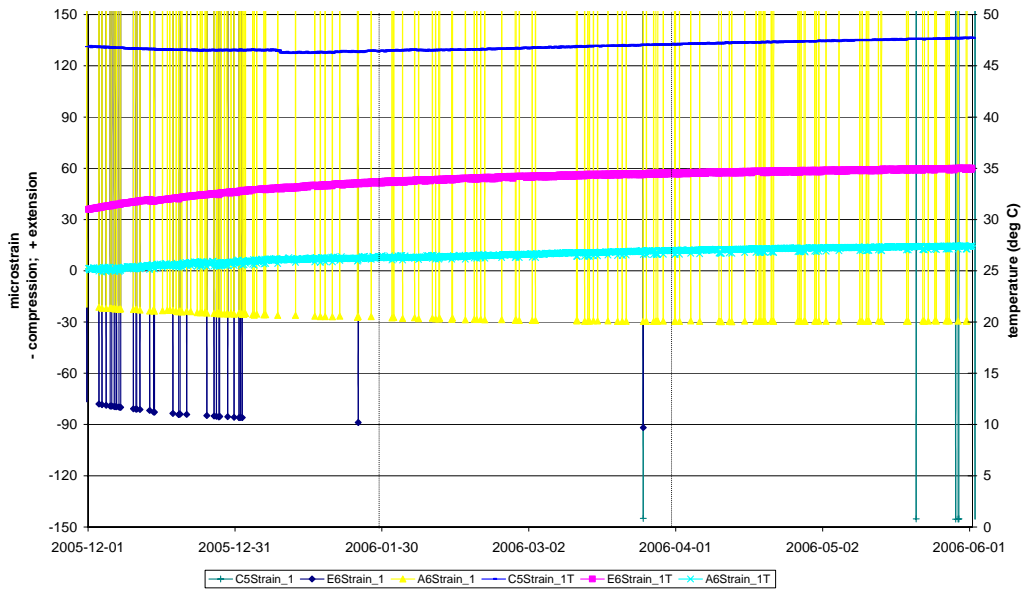


#### 4.2.4 Strain measurements in vertical primary boreholes

Vertical strain adjacent to Deposition Hole 5

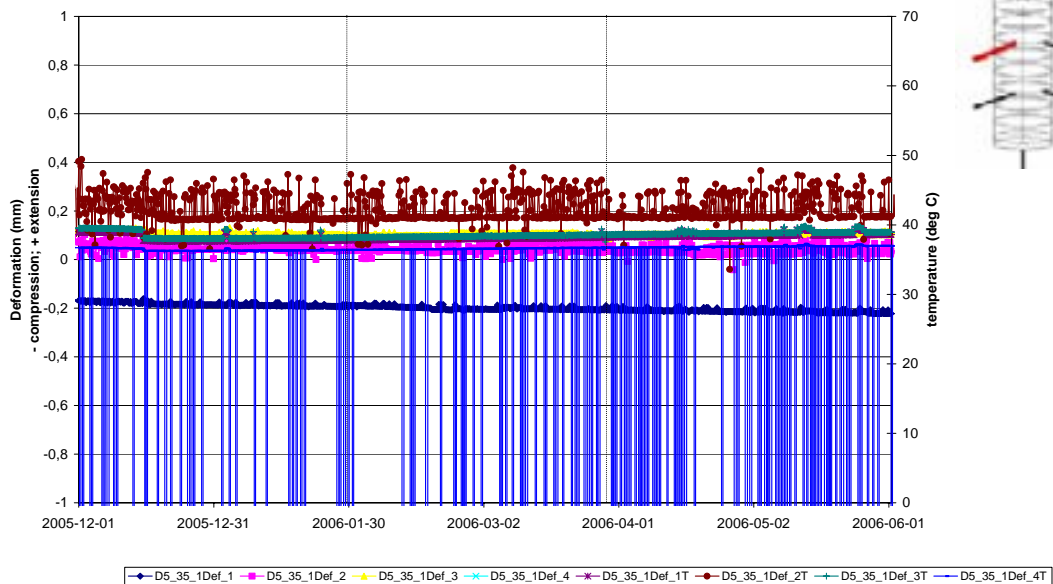


Vertical strain adjacent to Deposition Holes 5 and 6

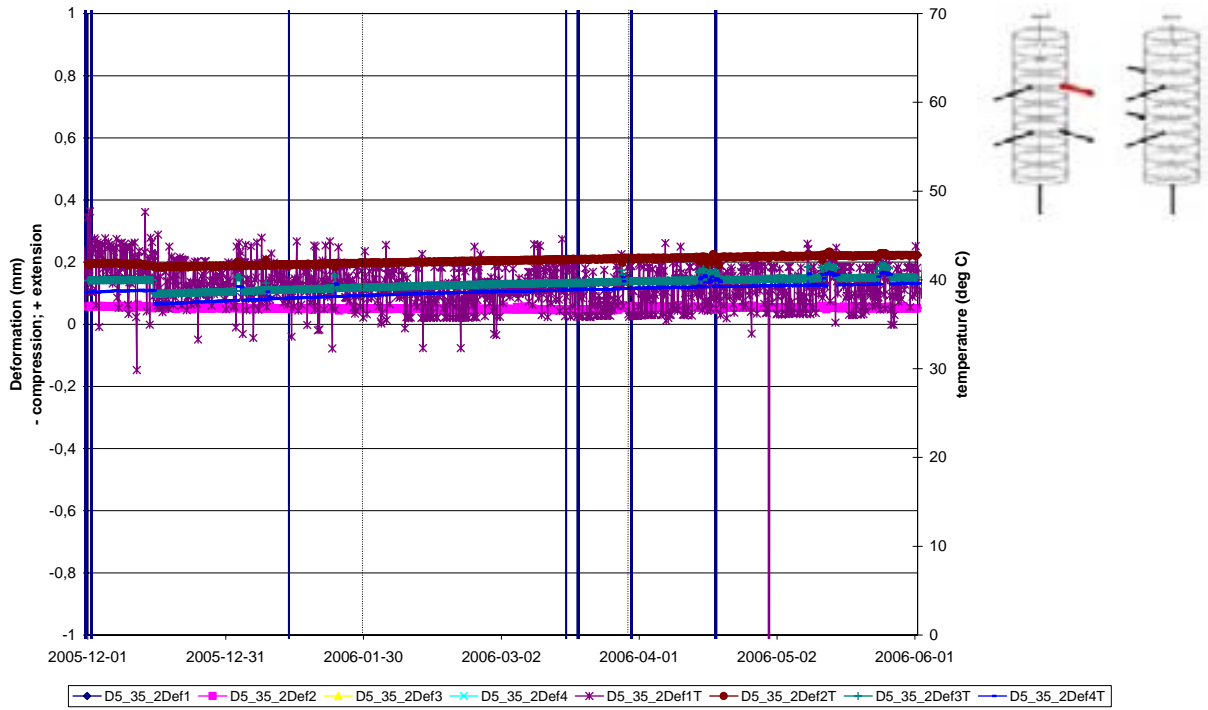


#### 4.2.5 Deformation measurements in horizontal complementary boreholes

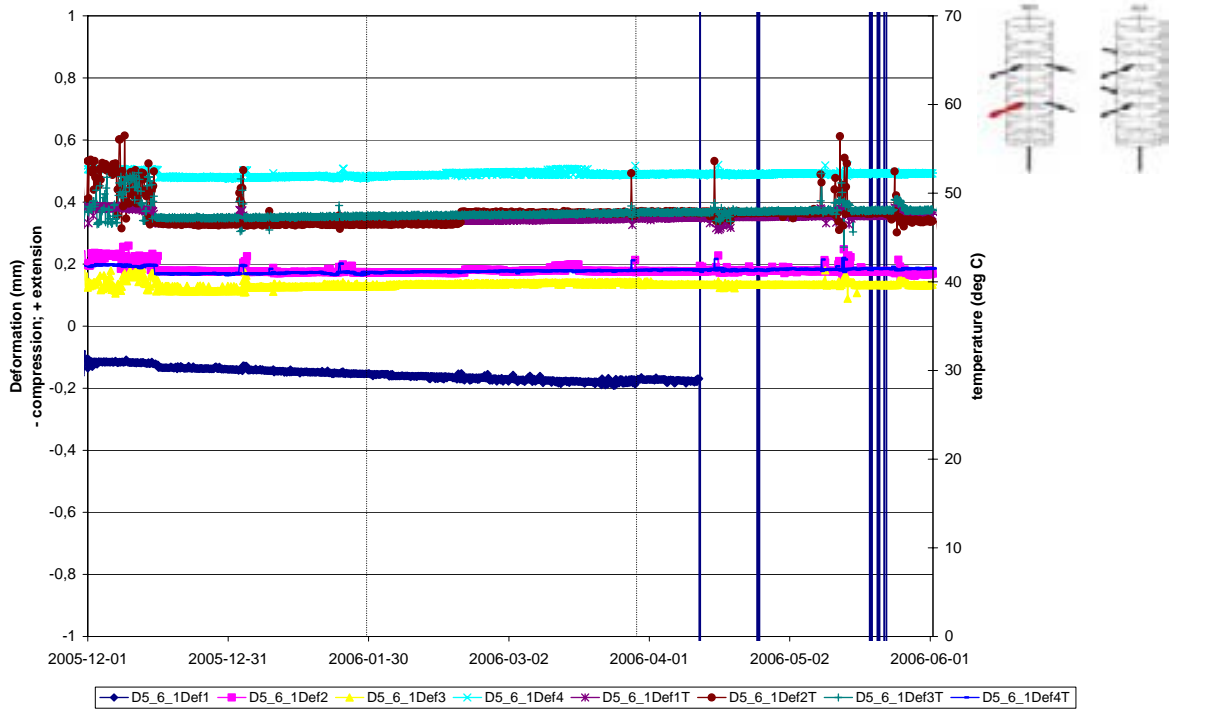
Deformation measurements  
Borehole D5:3.5(1)



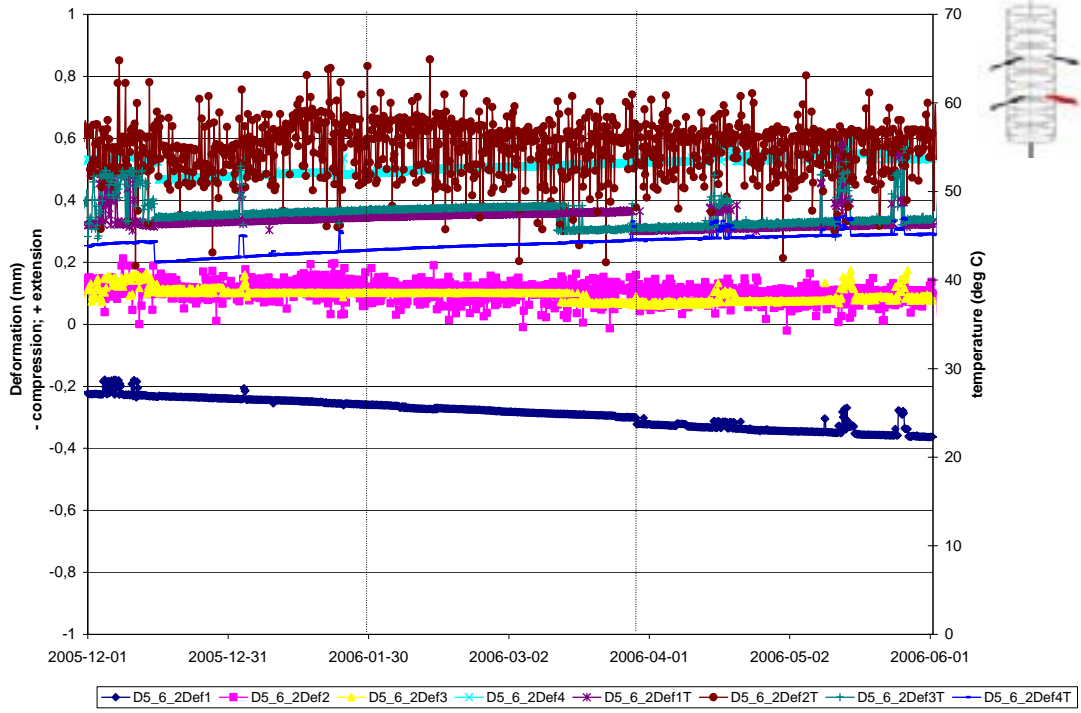
Deformation measurements  
Borehole D5:3.5(2)



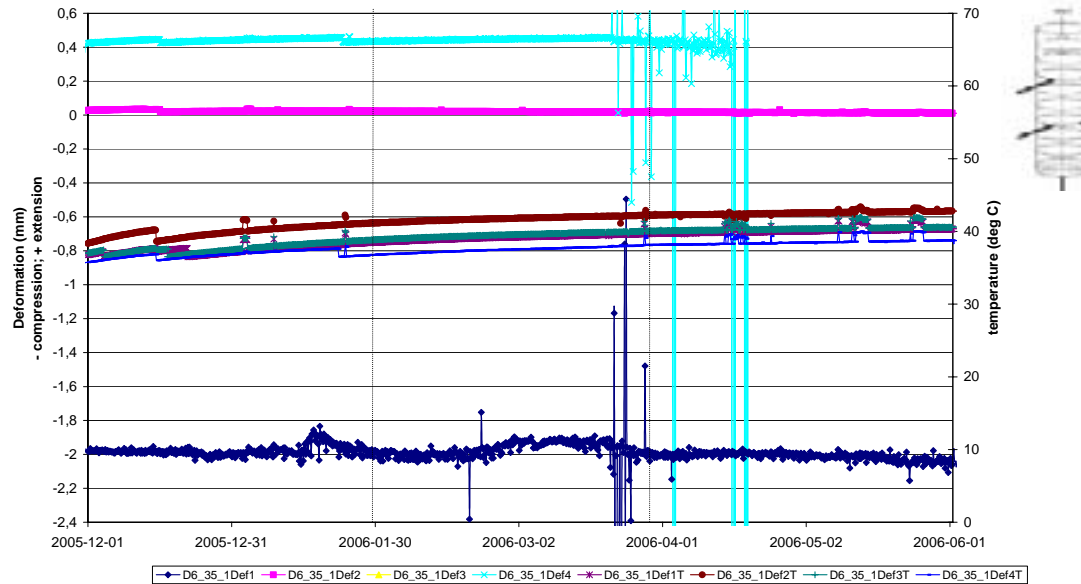
Deformation measurements  
Borehole D5:6(1)



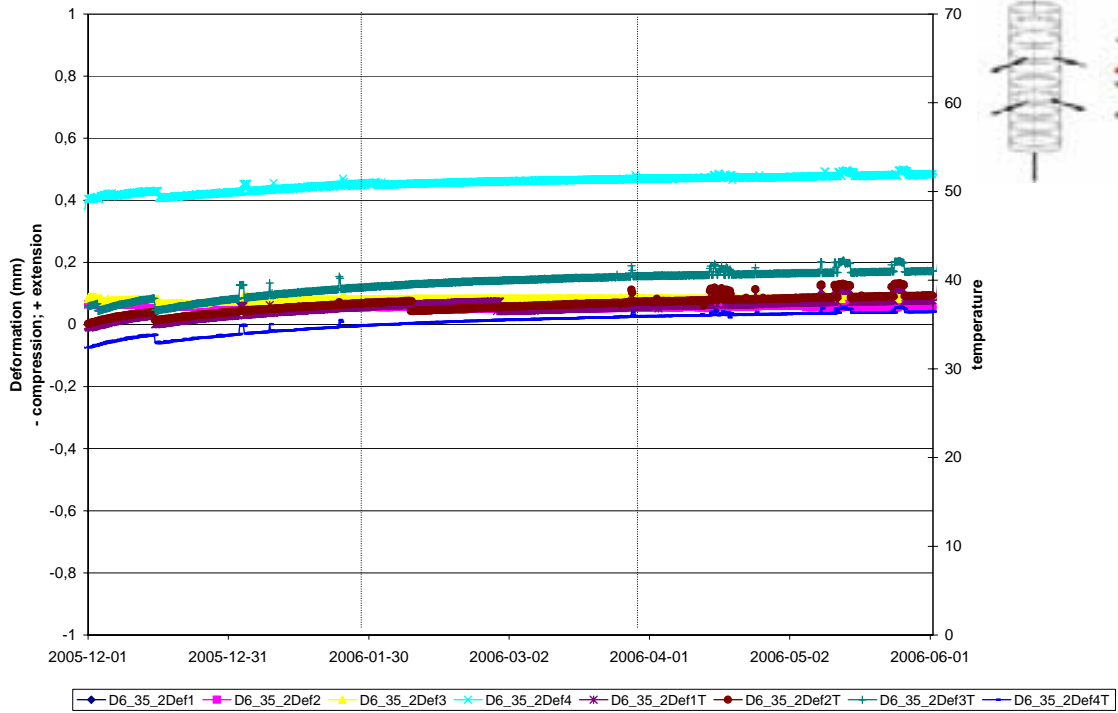
Deformation measurements  
Borehole D5:6(2)



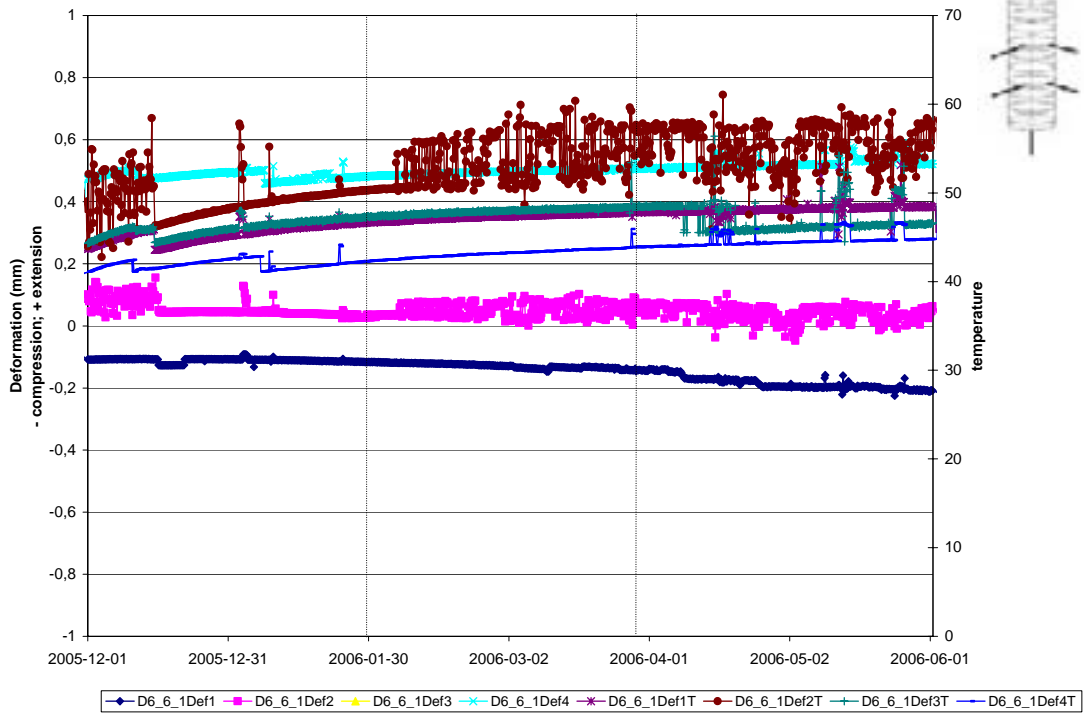
Deformation measurements  
Borehole D6:3.5(1)

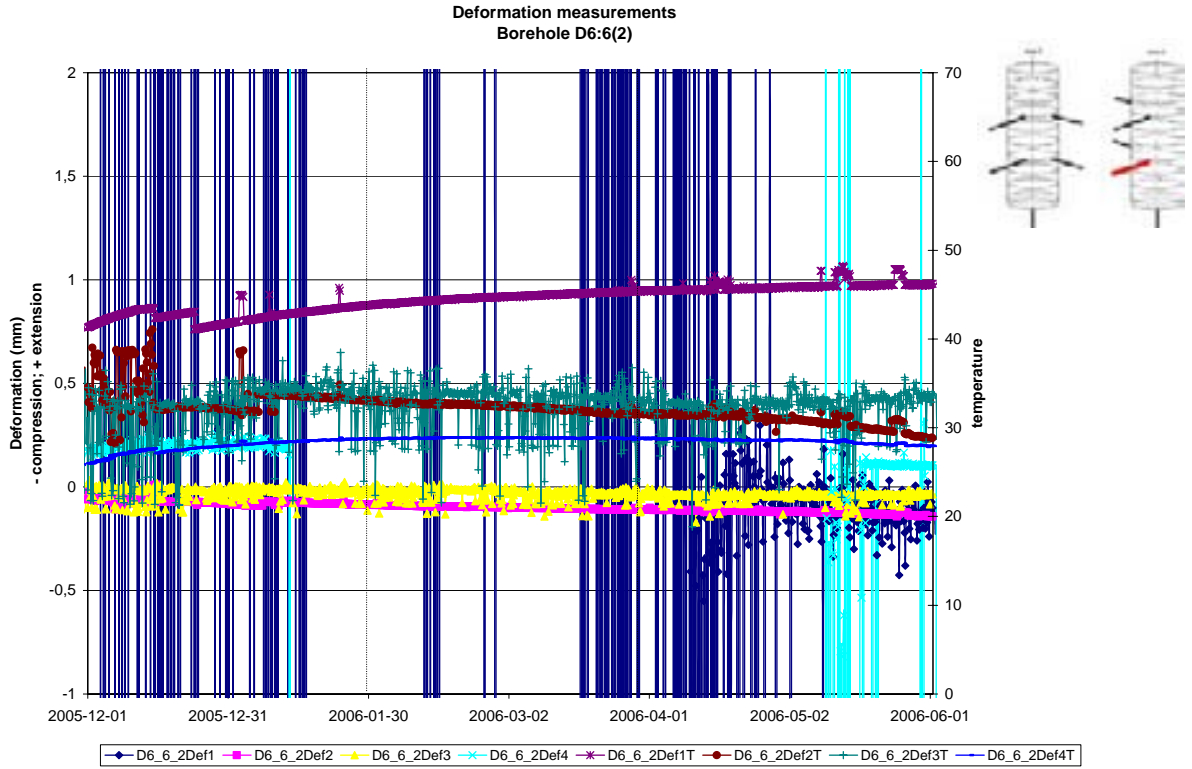


Deformation measurements  
Borehole D6:3.5(2)

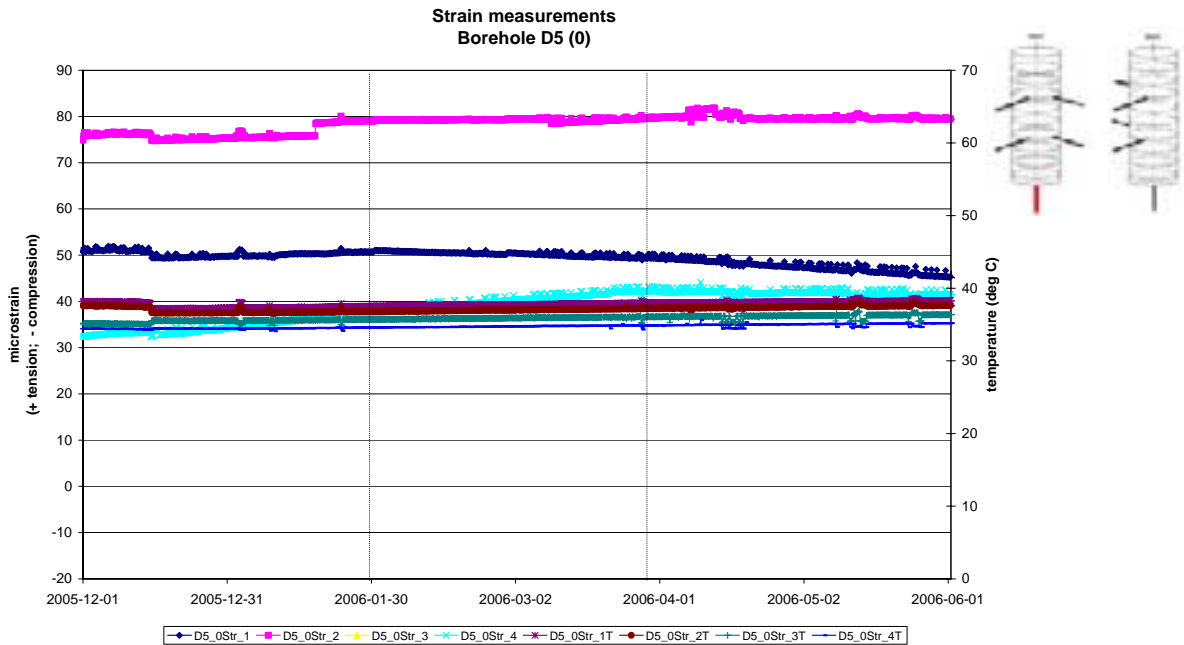


Deformation measurements  
Borehole D6:6(1)

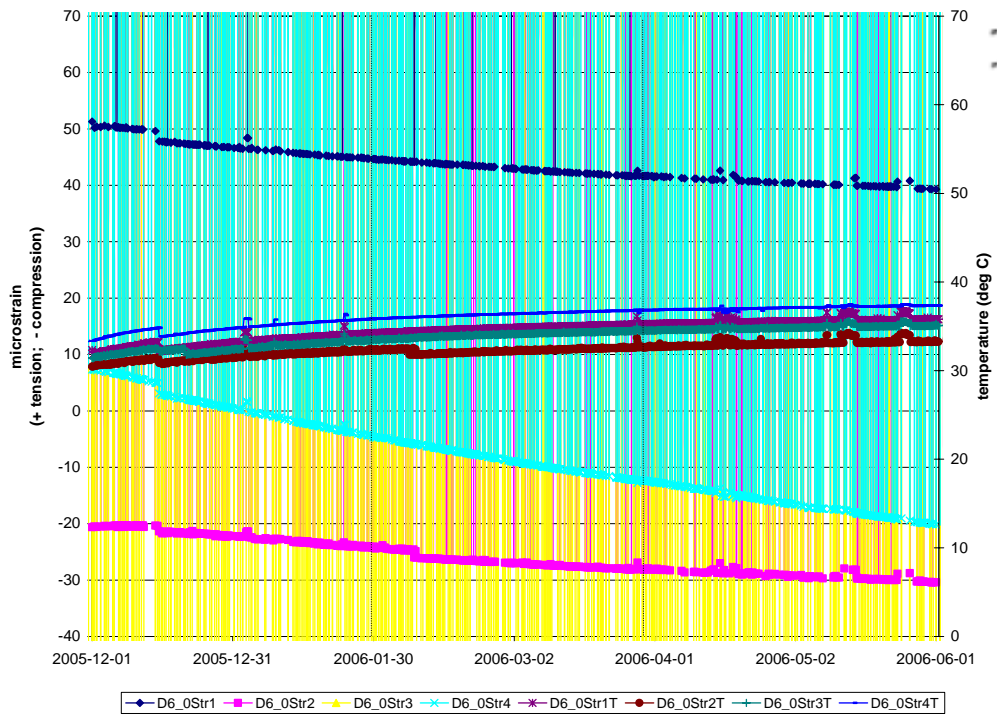




#### 4.2.6 Strain measurements in complementary boreholes



Strain measurements  
Borehole D6 (0)







## Appendix 11

### **Water pressure in the rock and flow measurements**

Rhén I. and Forsmark T., SWECO VIAK AB

Period 2001-09-01 – 2006-06-01



# Water pressure measurements in the rockmass

## Introduction

The hydraulic properties of the rock, geometry of tunnels and deposition holes, water pressure far away from the tunnels and the hydro-mechanical properties of the backfill and buffer govern the saturation of the buffer and backfill. It is important to measure the water pressure in the rock for the interpretation of the measurements in the buffer and backfill and to sample data useful for the modelling of the saturation process.

A short summary of the instrumentation follows below. For more details see (*Rhén et al, 2001*).

## Measurements in the boreholes

A large number of boreholes are instrumented with one or several packers. In all packed-off sections, the water pressure is measured. Each borehole section is connected to a tube of polyamide that via lead-through holes ends in the G-tunnel. All pressure transducers are placed in the G-tunnel to facilitate easy calibration and exchange of transducers that are out of order. The transducers are connected to the HMS system at Äspö Laboratory and it is a flexible system for changing the logging frequency. The maximum scan frequency is 1/second. During periods with no hydraulic tests, preliminary the logging (storing a value in the data base) frequency is 2/hour with an automatic increase of the sampling frequency if the pressure change since last registration is larger than 2kPa. During hydraulic tests, the sampling frequency is up to 1 logging every 3<sup>rd</sup> second (maximum logging rate possible).

## Instrumentation with bentonite packers in Section I

Section I will be in operation for a long time, possibly up to 20 years, and there will be no access to the instruments in the boreholes for a long period. It was decided to develop a new type of packer that was not dependent of an external pressure to seal-off the borehole sections. These packers are made of compacted bentonite with rubber coverage. For chemical reasons the bentonite is not allowed to be in contact with the surrounding water in the rock mass and therefore the packers have a cover made of polyurethane (PUR-rubber). This rubber also protected the packers against unwanted wetting during transport and installation. After installing all packers in a borehole, the compacted bentonite was wetted to make it swell and expanded against the borehole wall. This packer system is used in 14 boreholes with a length between 12 and 50 meters in the tunnel floor and the walls, see (*Rhén et al, 2001*).

Due to the expected high temperature near the deposition holes two boreholes (KA3574A and KA3576A) were equipped with stainless steel pipes instead of polyamide tubes.

In some sections used for circulation or hydrochemistry sampling purposes in Section I, a dummy is installed to reduce the water-filled volume of the section. Depending on the purpose the dummies were made either by high-density polyethylene (circulation sections) or PEEK (hydrochemistry sections) material. The dummy consists of two parts, positioned around the centre rod.

The packers were inserted into the borehole with Ø 20 mm massive stainless steel rods. A special designed manual-hoisting rig was used to insert the equipment into the boreholes. When the packers were at their correct position the equipment was attached to a locking device mounted on the tunnel wall at the borehole collar. Before insertion, the equipment was cleaned with a cleaner delivering hot steam (100 °C) at high pressure.

The instrument configuration for the boreholes provided with bentonite packers is summarised in *Table 1* and illustrated in *Figures 1* and *2*.

**Table 1 Instrumentation configuration in Section I. “Lead-through”: pipes between the packers.**

Borehole:sec	Sec. length (m)	Type of section	Type of dummy	Packer length	Lead-through (no:diameter:type)
KA3563G:1	15 – 30.01	P		2 m	1:6/4:PA
KA3563G:2	10 – 13	P		2 m	2:6/4:PA
KA3563G:3	4 – 8	P		1 m	3:6/4:PA
KA3563G:4	1.5 – 3	P, C	HD	1 m	6:6/4:PA
KA3566G01:1	23.5 – 30.01	P		2 m	1:6/4:PA
KA3566G01:2	20 – 21.5	P, C	HD	2 m	4:6/4:PA
KA3566G01:3	12 – 18	P		2 m	5:6/4:PA
KA3566G01:4	7.3 – 10	P		1 m	6:6/4:PA
KA3566G01:5	1.5 – 6.3	P, F		1 m	8:6/4:PA
KA3566G02:1	19 – 30.1	P		1 m	1:6/4:PA
KA3566G02:2	16 – 18	P, C	HD	2 m	4:6/4:PA
KA3566G02:3	12 – 14	P		1 m	5:6/4:PA
KA3566G02:4	8 – 11	P		2 m	6:6/4:PA
KA3566G02:5	1.3 – 6	P, F		1 m	8:6/4:PA
KA3572G01:1	7.3 – 12.03	P		2 m	1:6/4:PA
KA3572G01:2	2.7 – 5.3	P, C	HD	2 m	4:6/4:PA
KA3573A:1	26 – 40.07	P		2 m	1:6/4:PA
KA3573A:2	21 – 24	P, F		2 m	3:6/4:PA
KA3573A:3	14.5 – 19	P		2 m	4:6/4:PA
KA3573A:4	10.5 – 12.5	P, F		2 m	6:6/4:PA
KA3573A:5	1.3 – 8.5	P		1 m	7:6/4:PA
KA3574G01:1	8 – 12.03	P		1 m	1:6/4:ST
KA3574G01:2	5.1 – 7	P		1 m	2:6/4:ST
KA3574G01:3	1.8 – 4.1	P, C	HD	1 m	5:6/4:ST
KA3576G01:1	8 – 12.01	P		2 m	1:6/4:ST
KA3576G01:2	4 – 6	P, HC	PE	1 m	2:6/4:ST, 1:1/8"/2:PE
KA3576G01:3	1.3 – 3	P		1 m	3:6/4:ST, 1:1/8"/2:PE

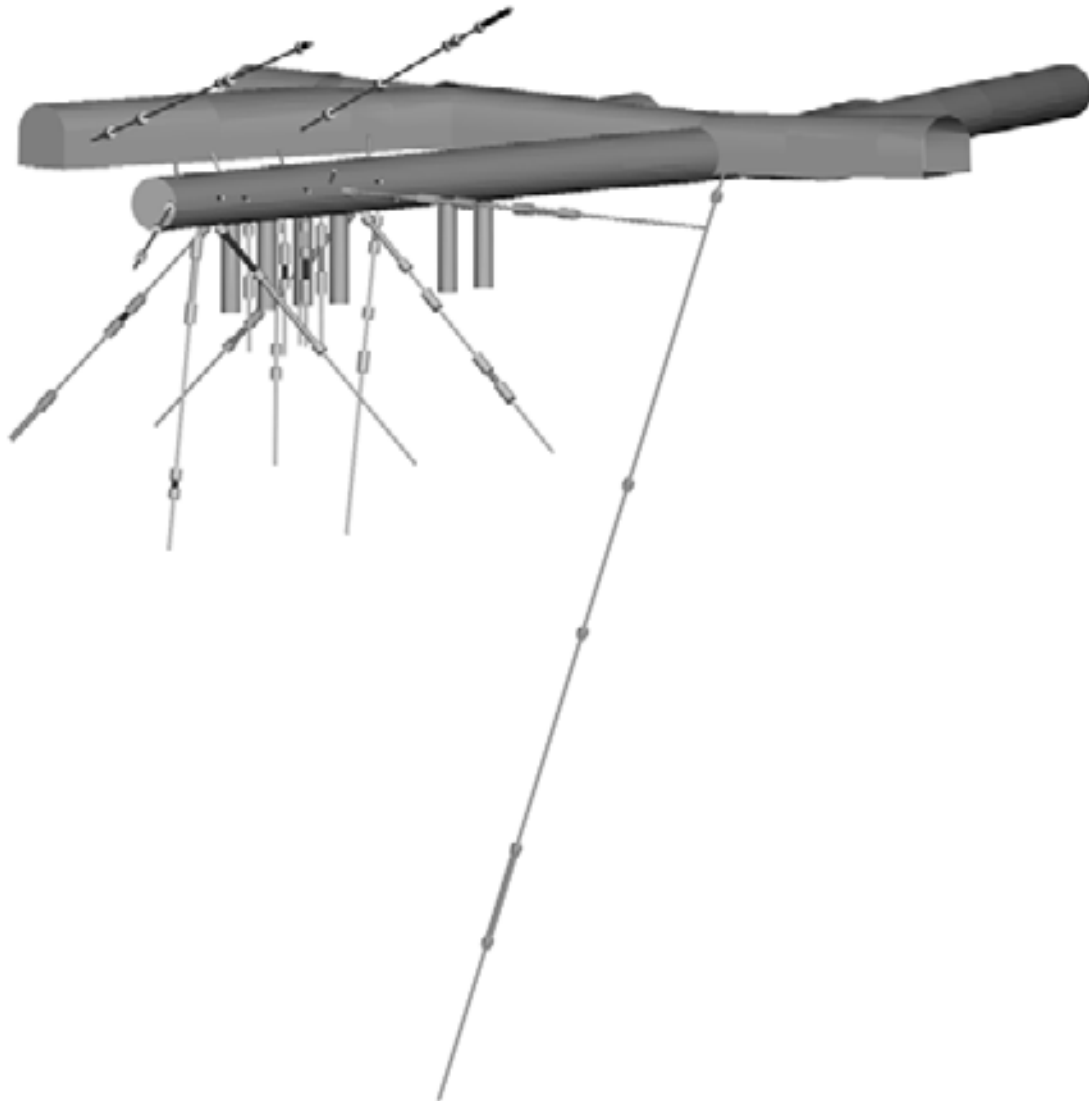
Borehole:sec	Sec. length (m)	Type of section	Type of dummy	Packer length	Lead-through (no:diameter:type)
KA3578G01:1	6.5 – 12.58	P		1 m	1:6/4:PA
KA3578G01:2	4.3 – 5.5	P, HC	PE	2 m	2:6/4:PA, 1:1/8"/2:PE
KA3579G:1	14.7 – 22.65	P		1 m	1:6/4:PA
KA3579G:2	12.5 – 13.7	P		1 m	2:6/4:PA
KA3579G:3	2.3 – 11.5	P		2 m	3:6/4:PA
KA3584G01:1	7 – 12	P		2 m	1:6/4:PA
KA3584G01:2	1.3 – 5	P		1 m	2:6/4:PA
KA3590G01:1	16 – 30	P		1 m	1:6/4:PA
KA3590G01:2	7 – 15	P, F, F		1 m	4:6/4:PA
KA3590G01:3	1.3 – 6	P, HC		1 m	5:6/4:PA, 1:1/8"/2:PE
KA3590G02:1	25.5 – 30.01	P, F		2 m	2:6/4:PA
KA3590G02:2	15.2 – 23.5	P		2 m	3:6/4:PA
KA3590G02:3	11.9 – 13.2	P, HC	PE	2 m	4:6/4:PA, 1:1/8"/2:PE
KA3590G02:4	1.3 – 9.9	P		1 m	5:6/4:PA, 1:1/8"/2:PE
KA3593G:1	25.2 – 30.02	P		1 m	1:6/4:PA
KA3593G:2	23.5 – 24.2	P, HC	PE	1 m	2:6/4:PA, 1:1/8"/2:PE
KA3593G:3	9 – 22.5	P		2 m	3:6/4:PA, 1:1/8"/2:PE
KA3593G:4	3 – 7	P, F		2 m	5:6/4:PA, 1:1/8"/2:PE
KA3600F:1	43 – 50.1	P		1 m	1:6/4:PA
KA3600F:2	40.5 – 42	P, HC	PE	1 m	2:6/4:PA, 1:1/8"/2:PE
KA3600F:3	20 – 39.5	P		2 m	3:6/4:PA, 1:1/8"/2:PE
KA3600F:4	1.3 – 18	P		1 m	4:6/4:PA, 1:1/8"/2:PE
KA3510A:1	125 – 150	P		1 m	1:6/4:PA
KA3510A:2	110 - 124	P, F		1 m	3:6/4:PA
KA3510A:3	75 - 109	P		1 m	4:6/4:PA
KA3510A:4	51 - 74	P		1 m	5:6/4:PA
KA3510A:5	4.5 - 50	P		1 m	6:6/4:PA
KG0021A01:1	42.5 – 48.82	P, HC		1 m	1:6/4:ST, 1:1/8"/2:PE
KG0021A01:2	37 – 41.5	P		1 m	2:6/4:PA, 1:1/8"/2:PE
KG0021A01:3	35 - 36	P, C	HD	1 m	5:6/4:PA, 1:1/8"/2:PE
KG0021A01:4	19 - 34	P		1 m	6:6/4:PA, 1:1/8"/2:PE
KG0021A01:5	5 - 18	P		1 m	7:6/4:PA, 1:1/8"/2:PE
KG0048A01:1	49 – 54.69	P, HC		1 m	1:6/4:ST, 1:1/8"/2:PE
KG0048A01:2	34.8 – 48	P		1 m	2:6/4:PA, 1:1/8"/2:PE
KG0048A01:3	32.8 – 33.8	P, C	HD	1 m	5:6/4:PA, 1:1/8"/2:PE
KG0048A01:4	13 – 31.8	P		1 m	6:6/4:PA, 1:1/8"/2:PE
KG0048A01:5	5 - 12	P		1 m	7:6/4:PA, 1:1/8"/2:PE

Type of section:

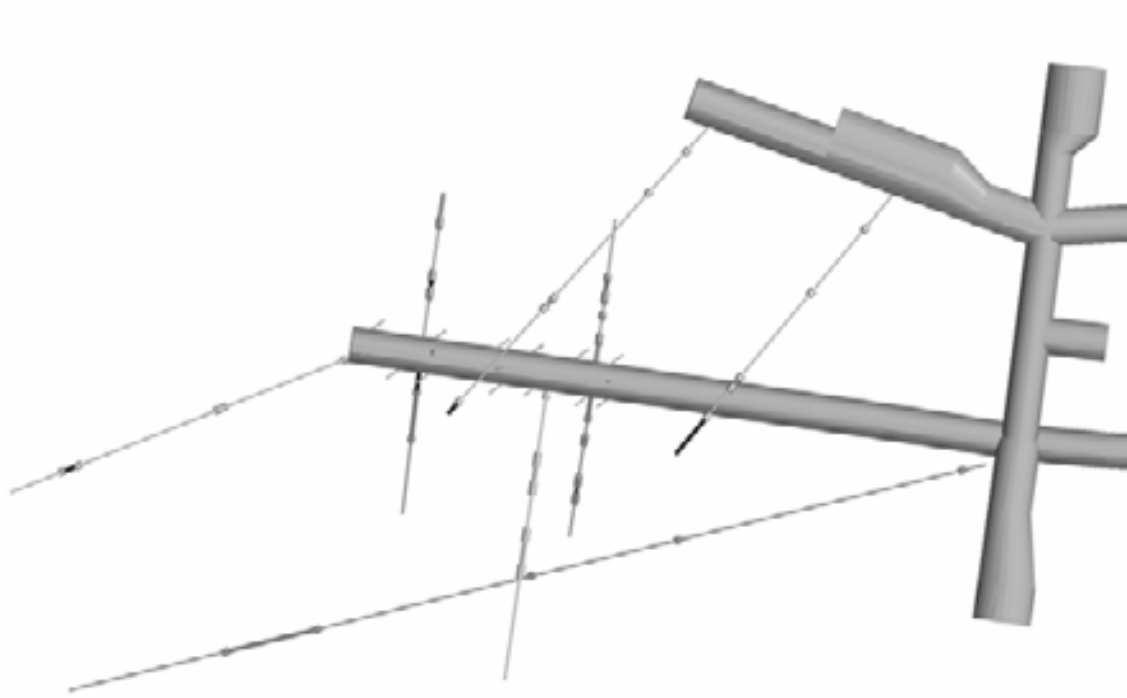
P Pressure measurement  
C Circulation possible  
HC Hydrochemistry sampling  
F Flow

Materials:

PA Polyamide  
ST Steel  
PE PEEK  
HD HD1000 (High Density Polyethylene)



**Figure 1.** View of the drilled core holes in the Prototype Repository Section I. The length from the I-tunnel to the end of the TBM-tunnel is 90 m. The diameter of the TBM tunnel is 5m and the diameter of the deposition holes is 1.75 m. The depth of the deposition holes is 8.37 m in the centre and 8.15 m along the deposition hole wall. The diameter of the core holes is 76 mm except for the short core holes in the roof of the TBM tunnel that have a diameter of 56 mm. The monitoring boreholes used in the presentation in this report are located in the inner part of the tunnel surrounding the area with the four innermost canister holes. Also included are two holes drilled from the G-tunnel and the long hole KA3510A drilled from the main tunnel.



*Figure 2. Overview of Sektion I in Prototype Repository*

## **Instrumentation with hydraulic packers in Section II**

Fifteen boreholes are equipped with hydraulically expanded packers of one meters length to seal off at most five sections in one borehole. In ten of these boreholes one section also is instrumented with hydro-mechanical equipment adapted to measure small deformations in the solid rock and over selected fractures. Another borehole in the G-tunnel is instrumented with HM equipment as a reference. The borehole was drilled in the north tunnel wall and is not expected to be influenced by the stress changes around the Prototype tunnel.

**Table 2 Instrumentation configuration in Section II. “Lead-through”: pipes between the packers.**

Borehole:sec	Sec. length (m)	Type of section	Tubes/pipes (no:diameter:type)
KA3539G:1	18.6 – 30	P	1:4/2:PA, 1:6/4:PA
KA3539G:2	15.85 – 17.6	P, HM, C	2:4/2:PA, 3:6/4:PA, 3:4/2:ST, 2:8/6:ST
KA3539G:3	10 – 14.85	P, F	3:4/2:PA, 4:6/4:PA, 3:4/2:ST, 2:8/6:ST
KA3539G:4	4 – 9	P	4:4/2:PA, 4:6/4:PA, 3:4/2:ST, 2:8/6:ST
KA3542G01:1	27 – 30	P	1:4/2:PA, 1:6/4:PA
KA3542G01:2	21.3 – 26	P	2:4/2:PA, 1:6/4:PA
KA3542G01:3	18.6 – 20.3	P, HM,C	3:4/2:PA, 3:6/4:PA, 3:4/2:ST, 2:8/6:ST
KA3542G01:4	10.5 – 17.6	P	4:4/2:PA, 3:6/4:PA, 3:4/2:ST, 2:8/6:ST
KA3542G01:5	3.5 – 9.5	P	5:4/2:PA, 3:6/4:PA, 3:4/2:ST, 2:8/6:ST
KA3542G02:1	28.2 – 30.01	P	1:4/2:PA, 1:6/4:PA
KA3542G02:2	25.6 – 27.2	P, HM, C	2:4/2:PA, 3:6/4:PA, 3:4/2:ST, 2:8/6:ST
KA3542G02:3	21.5 – 24.6	P	3:4/2:PA, 3:6/4:PA, 3:4/2:ST, 2:8/6:ST
KA3542G02:4	9 – 20.5	P	4:4/2:PA, 3:6/4:PA, 3:4/2:ST, 2:8/6:ST
KA3542G02:5	2 – 8	P, F	5:4/2:PA, 4:6/4:PA, 3:4/2:ST, 2:8/6:ST
KA3544G01:1	11.65 – 12	P	1:4/2:ST, 1:6/4:ST
KA3544G01:2	8.9 – 10.65	P, HM, C	5:4/2:ST, 3:6/4:ST, 2:8/6:ST
KA3544G01:3	3.5 – 7.9	P	6:4/2:ST, 3:6/4:ST, 2:8/6:ST
KA3546G01:1	9.3 – 12	P	1:4/2:ST, 1:6/4:ST
KA3546G01:2	6.75 – 8.3	P, HM, C	5:4/2:ST, 3:6/4:ST, 2:8/6:ST
KA3546G01:3	1.5 – 5.75	P	6:4/2:ST, 3:6/4:ST, 2:8/6:ST
KA3548A01:1	21.5 – 30	P	1:4/2:PA, 1:6/4:PA
KA3548A01:2	11.75 – 20.5	P, F	2:4/2:PA, 2:6/4:PA
KA3548A01:3	8.8 – 10.75	P, HM, C	3:4/2:PA, 4:6/4:PA, 3:4/2:ST, 2:8/6:ST
KA3548A01:4	3 – 7.8	P	4:4/2:PA, 4:6/4:PA, 3:4/2:ST, 2:8/6:ST
KA3548G01:1	6-12	P	2:6/4:PA
KA3548G01:2	2-5	P	3:6/4:PA
KA3550G01:1	8.3 – 12.03	P	1:4/2:ST, 1:6/4:ST
KA3550G01:2	5.2 – 7.3	P, HM, C	5:4/2:ST, 3:6/4:ST, 2:8/6:ST
KA3550G01:3	1.8 – 4.2	P	6:4/2:ST, 3:6/4:ST, 2:8/6:ST
KA3550G05:1	1.5 – 3	P	1:4/2:ST, 1:6/4:ST
KA3551G05:1	1.5 – 3.1	P	1:4/2:ST, 1:6/4:ST
KA3552G01:1	7.05 – 12	P	1:4/2:ST, 1:6/4:ST
KA3552G01:2	4.35 – 6.05	P, HM, C	5:4/2:ST, 3:6/4:ST, 2:8/6:ST
KA3552G01:3	1.5 – 3.35	P	6:4/2:ST, 3:6/4:ST, 2:8/6:ST
KA3554G01:1	25.15 – 30.01	P	1:4/2:PA, 1:6/4:PA
KA3554G01:2	22.6 – 24.15	P, HM, C	2:4/2:PA, 3:6/4:PA, 3:4/2:ST, 2:8/6:ST
KA3554G01:3	14 – 21.6	P	3:4/2:PA, 3:6/4:PA, 3:4/2:ST, 2:8/6:ST
KA3554G01:4	5 – 13	P	4:4/2:PA, 3:6/4:PA, 3:4/2:ST, 2:8/6:ST
KA3554G01:5	1.5 – 4	P	5:4/2:PA, 3:6/4:PA, 3:4/2:ST, 2:8/6:ST



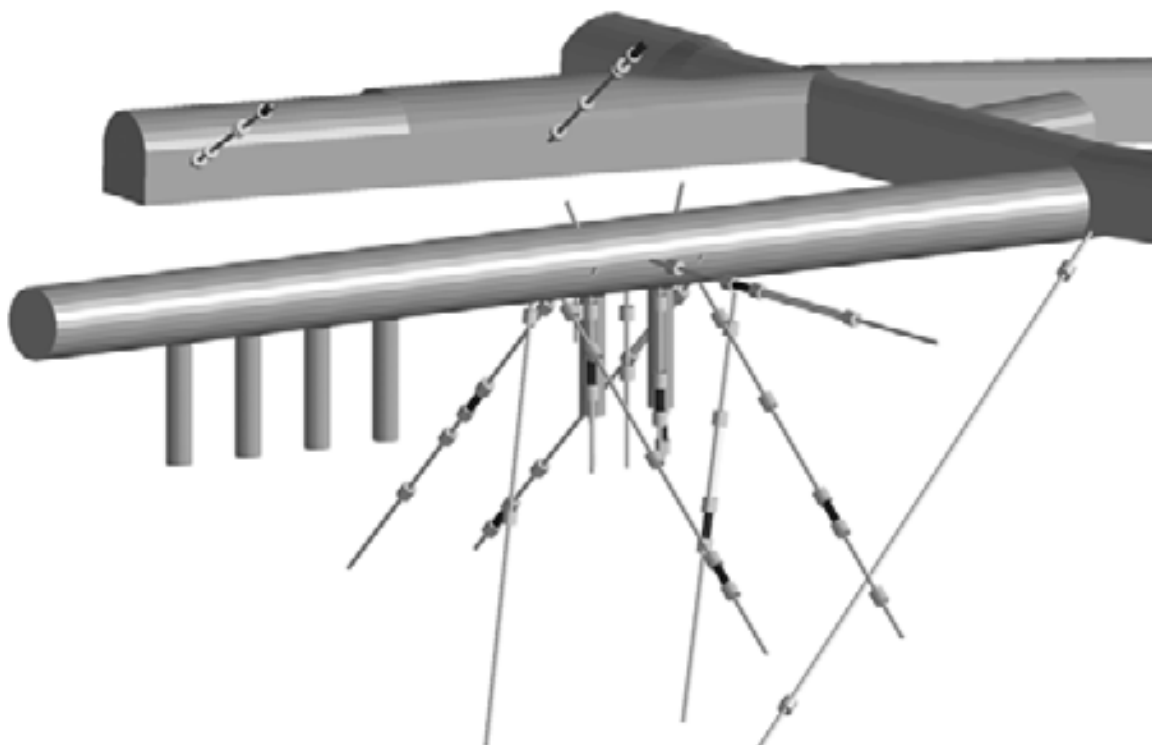
Borehole:sec	Sec. length (m)	Type of section	Tubes/pipes (no:diameter:type)
KA3554G02:1	22 – 30.01	P	1:4/2:PA, 1:6/4:PA
KA3554G02:2	15.9 – 21	P	2:4/2:PA, 1:6/4:PA
KA3554G02:3	13.2 – 14.9	P	3:4/2:PA, 1:6/4:PA
KA3554G02:4	10.5 – 12.2	P, HM, C	4:4/2:PA, 3:6/4:PA, 3:4/2:ST, 2:8/6:ST
KA3554G02:5	1.5 – 9.5	P	5:4/2:PA, 3:6/4:PA, 3:4/2:ST, 2:8/6:ST
KA3557G:1	15 – 30.04	P	1:4/2:PA, 1:6/4:PA
KA3557G:2	1.5 – 14	P	2:4/2:PA, 1:6/4:PA
KG0010B01:1	2.8 – 4.35	HM	3:4/2:ST, 2:8/6:ST

Type of section:

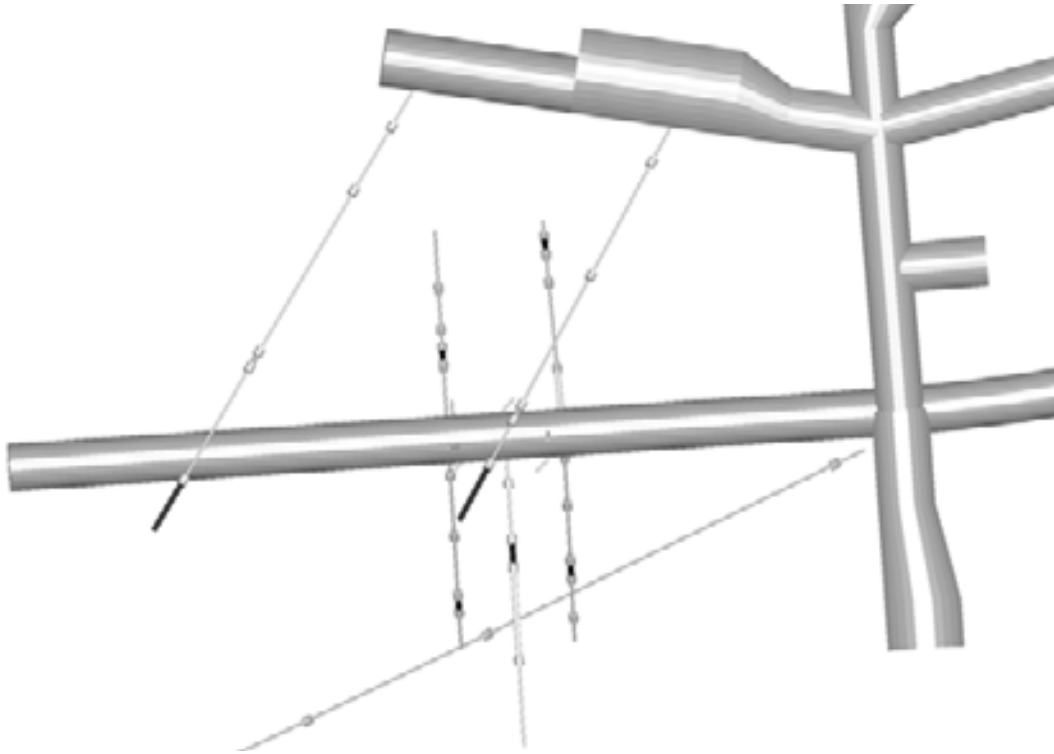
P Pressure measurement  
C Circulation possible  
HM Hydro-mechanical measurements

Materials:

PA Polyamide tube  
ST Stainless steel pipe  
F Flow



**Figure 3** View of the drilled core holes in the Prototype Repository Section II. The length from the I-tunnel to the end of the TBM-tunnel is 90 m. The diameter of the TBM tunnel is 5m and the diameter of the deposition holes is 1.75 m. The depth of the deposition holes is 8.37 m in the centre and 8.15 m along the deposition hole wall. The diameter of the core holes is 76 mm except for the short core holes in the roof of the TBM tunnel that have a diameter of 56 mm. The monitoring boreholes used in the presentation in this report are located in the inner part of the tunnel surrounding the area with the four innermost canister holes. Also included are two holes drilled from the G-tunnel and the long hole KA3510A drilled from the main tunnel.



*Figure 4 Overview of Sektion II in Prototype Repository*

### **Instrumentation with mechanical packers**

Twenty-two short boreholes (2 m) in the tunnel roof and walls are equipped with mechanical packers, see *Table 3*. After insertion into the hole, the pulling of a nut on the centre pipe expanded the packer. Since these holes are directed upwards, the de-airation required an extra lead-through connected to a tube ending in the innermost part of the borehole. The de-airation was made during the backfilling and in boreholes with very little flow the de-airation was made by filling water through the outer tube.

**Table 3 Boreholes instrumented with mechanical packers**  
 (“Inclination”: inclination of the borehole)

Borehole	Borehole length (m)	Inclination (°)
KA3543A01	2.06	-0.8
KA3543I01	2.06	70.5
KA3548D01	2.06	2.7
KA3552A01	2.06	-2.8
KA3552H01	2.1	58.2
KA3553B01	2.02	-37.7
KA3563A01	2.06	-7.7
KA3563D01	approx. 2	2.8
KA3563I01	2.15	73
KA3566C01	2.1	3.5
KA3568D01	2.3	-2.3
KA3573C01	2.05	34.9
KA3574D01	2.05	12.6
KA3578C01	2.09	-5.4
KA3578H01	1.9	59.1
KA3579D01	2	-1
KA3588C01	2.04	-4
KA3588D01	1.9	-1.8
KA3588I01	1.96	65.6
KA3592C01	2.1	4.4
KA3597D01	2.22	3.1
KA3597H01	2.06	55.1

## Calibration intervals

Recalibration of pressure transducers are made a couple of times every year.

## Pressure measurements

In this section pressure measurements of all monitored holes in the Prototype repository is shown in plots below. The pressure values plotted are daily mean values. The definition of day 0 is the day the heating of canister 1 started, i.e. 2001-09-17. In *Table 4* the dates of the starting of the heaters in all canisters are presented.

**Table 4 Starting of heaters in canisters**

Canister in deposition hole	Date
1 (DA3587G)	2001-09-17
2 (DA3581G)	2001-09-24
3 (DA3575G)	2001-11-10
4 (DA3569G)	2001-11-24
5 (DA3551G)	2003-05-08
6 (DA3545G)	2003-05-23

The position of pressure measurement is indicated for all observation sections.

In general sections close to the prototype rock wall indicate lower pressure head than further away from the prototype.

In the longer holes the section closest to the wall have a lower head than sections deeper into the rockmass.

A pressure drop 2002-05-07 for most of the observation sections are shown in the plots. The most major pressure change happens in the lowest section of KA3566G02 (approx. 70 m) but are also clearly visible for section 2-4 of the same borehole. The pressure recovered during the evening of 2002-12-02. The cause for the pressure change is unknown.

Several sections have had a slight decreasing trend since the summer of 2002. This trend have in most cases been discontinued after 2004-11-01.

The instrumentation of boreholes in Section II started 2002-11-06 and continued until the beginning of December 2002. Several sections indicate a pressure drop around 2002-11-11 which probably is caused by the installation work.

The sections of KA3510A show a drop of pressure during the the first week of December 2002. The pressure is quickly re-established. Probably the cause for this was the on-going monitoring work in Section II.

During the period 2003-05-08 until 2003-05-15 a total of 19 hydraulic tests were done in several of the boreholes in Section I and II. The tests caused groundwater pressure interference in the whole of the prototype repository area. Since the tests were mostly short-time tests it is only shown in some of the borehole section plots.

During the summer 2003 (2003-07-13 to 2003-08-05) no pressure data was recorded. In some of the long boreholes inclined to the south of the prototype show a pressure drop in mid-August.

The packers in KA3550G01 were deflated 2003-08-18 and has not been possible to re-inflate again. The reason is probably a tube leakage.

Hydraulic single hole tests were done in nine boreholes during 2003-10-21 – 10-23. The tests caused groundwater pressure interference in the whole of the prototype repository area. Since the tests were mostly short-time tests it is only shown in some of the borehole section plots.

The packers in five boreholes were deflated around Oct 30 – Nov 1, 2003. This was probably generated by a tube leakage which in its turn emptied the water in the pressure vessel and finally emptied the gas tube connected to it. The boreholes whose packers were deflated were KA3542G01, KA3542G02, KA3544G01 and KA3548A01. It was possible to inflate the packers in three of the four boreholes on 2003-11-10. It was not possible to restore the status of KA3544G01. This pressure drop is observed in several other borehole observation sections.

Hydraulic single hole tests were done in eight boreholes during 2004-02-02 – 02-04. The tests caused groundwater pressure interference in the whole of the prototype repository area. Since the tests were mostly short-time tests it is only shown in some of the borehole section plots.

A pressure drop of around 700 kPa in KA3566G01:4 is observed 2004-02-25. It remained so for some weeks before recovering, but dropped again in May and remains that way at the end of the month. This pattern was observed in this section during the spring 2003. The following investigation showed a faulty data-scan coupling (corrosion) which were replaced 2004-08-10.

Hydraulic single hole tests were done in eight boreholes during 2004-08-11 – 08-18. The tests caused groundwater pressure interference in the whole of the prototype repository area. Since the tests were mostly short-time tests it is only shown in some of the borehole section plots.

During the period 2005-01-19 until 2005-01-28 a total of 26 hydraulic tests were done in several of the boreholes in Section I and II. The tests caused groundwater pressure interference in the whole of the prototype repository area. Since the tests were mostly short-time tests it is only shown in some of the borehole section plots.

During week 36, starting 2005-09-05, several boreholes have a rather sudden drop in pressure which does not recover immediately. The reason is not known yet.

During week 39, starting 2005-10-01, pressure in KA3557G decreased rather suddenly. This was due to an empty gas pressure vessel, which has been replaced by now (January 2006).

Hydraulic single hole tests were done in eight boreholes during 2005-11-28 – 12-02. A total of 17 tests were done. The tests caused groundwater pressure interference in the whole of the prototype repository area. Since the tests were mostly short-time tests it is only shown in some of the borehole section plots.

In KA3573A the pressure in section 3 suddenly decreases around 200 kPa 2006-02-12/13. This is the initial phase as it turned out later, see below, of the total pressure loss of that section.

In KA3566G01 sections 2 and 3, and 4 and 5 respectively are short-cut from 2006-03-03. The reason is not known.

A pressure drop in several borehole sections on the south side of the prototype repository is observed from approximately 2006-04-18. At the same time the drainage from Section 1 increases from 1.5 to 9 L/min. Section KA3573A:3 which loses most of its pressure head is believed to lead groundwater, together with sections KA3573A:2 & 4, into the Section 1 backfill. In earlier investigations this borehole had flowrates over 50 L/min (*Rhén, Forsmark, 2001*). The following borehole/sections are affected by this pressure drop event: KA3510A:3-5, KA3539G, KA3542G01, KA3548A01, KA3554G01, KA3566G01:1, KA3573A:2-4, KA3590G01:1-2, KG0021A01:1-4 and KG0048A01:1-4. The pressure decrease is probably a result of a leaking tube or a tube coupling from KA3573A:3. The pressure in KA3573A:3 is now at the same level as the pressure in the backfill (around 500 kPa).

In *Table 5* the pressure sensor status 2006-06-01 is estimated based on pressure head data. It is to be noted as an estimation only.

**Table 5 Apparent pressure sensor status**

<b>Borehole:sec</b>	<b>Secup (m)</b>	<b>Seclow (m)</b>	<b>Pressure status 2006-06-01</b>	<b>Comment</b>
KA3510A:1	125.00	150.00	OK	
KA3510A:2	110.00	124.00	OK	
KA3510A:3	75.00	109.00	OK	
KA3510A:4	51.00	74.00	OK	
KA3510A:5	4.50	50.00	OK	
KA3539G:1	18.60	30.00	OK	
KA3539G:2	15.85	17.60	OK	
KA3539G:3	10.00	14.85	OK	
KA3539G:4	4.00	9.00	OK	
KA3542G01:1	27.00	30.00	OK	
KA3542G01:2	21.30	26.00	OK	
KA3542G01:3	18.60	20.30	OK	
KA3542G01:4	10.50	17.60	OK	
KA3542G01:5	3.50	9.50	OK	
KA3542G02:1	28.20	30.01	OK	
KA3542G02:2	25.60	27.20	OK	
KA3542G02:3	21.50	24.60	OK	
KA3542G02:4	9.00	20.50	OK	
KA3542G02:5	2.00	8.00	OK	
KA3543A01:1	0.65	2.06	Not OK	Air in borehole section?
KA3543I01:1	0.65	2.06	Not OK	Air in borehole section?
KA3544G01:1	11.65	12.00	Not OK?	Shortcut between sections.
KA3544G01:2	8.90	10.65	Not OK?	Shortcut between sections.
KA3544G01:3	3.50	7.90	Not OK?	Shortcut between sections.
KA3546G01:1	9.30	12.00	OK	
KA3546G01:2	6.75	8.30	OK	
KA3546G01:3	1.50	5.75	OK	
KA3548A01:1	21.50	30.00	OK	
KA3548A01:2	11.75	20.50	OK	
KA3548A01:3	8.80	10.75	OK	
KA3548A01:4	3.00	7.80	OK	
KA3548D01:1	0.65	2.06	Not OK	Air in borehole section?
KA3548G01:1	6.00	12.00	OK	
KA3548G01:2	2.00	5.00	OK	
KA3550G01:1	8.30	12.03	Not OK?	Shortcut between sections.
KA3550G01:2	5.20	7.30	Not OK?	Shortcut between sections.
KA3550G01:3	1.80	4.20	Not OK?	Shortcut between sections.
KA3550G05:1	1.50	3.00	OK	
KA3551G05:1	1.50	3.10	OK	
KA3552A01:1	0.65	2.06	Not OK	Air in borehole section?
KA3552G01:1	7.05	12.00	OK	
KA3552G01:2	4.35	6.05	OK	
KA3552G01:3	1.50	3.35	OK	
KA3552H01:1	0.65	2.10	Not OK	Air in borehole section?
KA3553B01:1	0.65	2.02	OK	
KA3554G01:1	25.15	30.01	OK	
KA3554G01:2	22.60	24.15	OK	
KA3554G01:3	14.00	21.60	OK	
KA3554G01:4	5.00	13.00	OK	
KA3554G01:5	1.50	4.00	OK	
KA3554G02:1	22.00	30.01	OK	
KA3554G02:2	15.90	21.00	OK	
KA3554G02:3	13.20	14.90	OK	
KA3554G02:4	10.50	12.20	OK	
KA3554G02:5	1.50	9.50	OK	
KA3557G:1	15.00	30.04	Not OK	Packer failure
KA3557G:2	1.50	14.00	Not OK	Packer failure
KA3563A01:1	0.65	2.06	Not OK	Air in borehole section?

Borehole:sec	Secup (m)	Seclow (m)	Pressure status 2006-06-01	Comment
KA3563D01:1	0.65	2.01	OK	
KA3563G:1	15.00	30.01	OK	
KA3563G:2	10.00	13.00	OK	
KA3563G:3	4.00	8.00	OK	
KA3563G:4	1.50	3.00	OK	
KA3563I01:1	0.65	2.15	OK	
KA3566C01:1	0.65	2.1	OK	
KA3566G01:1	23.50	30.01	OK	
KA3566G01:2	20.00	21.50	Not OK?	Shortcut between sections 2 and 3
KA3566G01:3	12.00	18.00	Not OK?	Shortcut between sections 2 and 3
KA3566G01:4	7.30	10.00	Not OK?	Shortcut between sections 4 and 5
KA3566G01:5	1.50	6.30	Not OK?	Shortcut between sections 4 and 5
KA3566G02:1	19.00	30.10	Not OK	Pressure drop September 2005
KA3566G02:2	16.00	18.00	Not OK	Not recovered after sampling Feb 2005
KA3566G02:3	12.00	14.00	OK	
KA3566G02:4	8.00	11.00	OK	
KA3566G02:5	1.30	6.00	OK	
KA3568D01:1	0.65	2.30	OK	
KA3572G01:1	7.30	12.03	OK	
KA3572G01:2	2.70	5.30	OK	
KA3573A:1	26.00	40.07	OK	
KA3573A:2	21.00	24.00	Not OK?	Probable tube failure in section 3
KA3573A:3	14.50	19.00	Not OK	Probable tube or tube coupling failure
KA3573A:4	10.50	12.50	Not OK?	Probable tube failure in section 3
KA3573A:5	1.30	8.50	OK	
KA3573C01:1	0.65	2.05	OK	
KA3574D01:1	0.65	2.05	OK	
KA3574G01:1	8.00	12.03	OK	
KA3574G01:2	5.10	7.00	OK	
KA3574G01:3	1.80	4.10	OK	
KA3576G01:1	8.00	12.01	OK	
KA3576G01:2	4.00	6.00	Not OK?	Shortcut between sections.
KA3576G01:3	1.30	3.00	Not OK?	Shortcut between sections.
KA3578C01:1	0.65	2.09	OK	
KA3578G01:1	6.50	12.58	OK	
KA3578G01:2	4.30	5.50	OK	
KA3578H01:1	0.65	1.90	OK	
KA3579D01:1	0.65	2.00	Not OK	Air in borehole section?
KA3579G:1	14.70	22.65	OK	
KA3579G:2	12.50	13.70	OK	
KA3579G:3	2.30	11.50	Not OK	Air in borehole section?
KA3584G01:1	7.00	12.00	OK	
KA3584G01:2	1.30	5.00	OK	
KA3588C01:1	0.65	2.04	OK	
KA3588D01:1	0.65	1.90	Not OK	Pressure drop June 2005
KA3588I01:1	0.65	1.96	OK	
KA3590G01:1	16.00	30.00	Not OK?	Shortcut between sections.
KA3590G01:2	7.00	15.00	Not OK?	Shortcut between sections.
KA3590G01:3	1.30	6.00	OK	
KA3590G02:1	25.50	30.01	OK	
KA3590G02:2	15.20	23.50	OK	
KA3590G02:3	11.90	13.20	OK	
KA3590G02:4	1.30	9.90	OK	
KA3592C01:1	0.65	2.01	OK	
KA3593G:1	25.20	30.02	Not OK	Unprobable low pressure in section
KA3593G:2	23.50	24.20	OK	
KA3593G:3	9.00	22.50	OK	
KA3593G:4	3.00	7.00	OK	
KA3597D01:1	0.65	2.22	OK	

Borehole:sec	Secup (m)	Seclow (m)	Pressure status 2006-06-01	Comment
KA3597H01:1	0.65	2.06	OK	
KA3600F:1	43.00	50.10	OK	
KA3600F:2	40.50	42.00	OK	
KA3600F:3	20.00	39.50	OK	
KA3600F:4	1.30	18.00	OK	
KG0021A01:1	42.50	48.82	OK	
KG0021A01:2	37.00	41.50	OK	
KG0021A01:3	35.00	36.00	OK	
KG0021A01:4	19.00	34.00	OK	
KG0021A01:5	5.00	18.00	OK	
KG0048A01:1	49.00	54.69	OK	
KG0048A01:2	34.8	48	OK	
KG0048A01:3	32.80	33.80	OK	
KG0048A01:4	13.00	31.80	OK	
KG0048A01:5	5.00	12.00	OK	

## Drainage of Section I

The drainage system in Section I was shut down 2004-11-01. It resulted in a major pressure increase in most borehole sections close to the prototype tunnel. The pressure increased until 2004-12-06.

The drained water amount was approximately 2.5 L/min. The flowrate of weir MG0004G decreased accordingly with the same order of magnitude after November 1.

The drainage system was re-opened 2004-12-06 due to electrical problems with the canister heaters. It is still open (2006-06-01). The pressure in most borehole sections within Section I decreased rapidly again after the re-opening while the pressures in Section II decreased more slowly.

In mid-April 2006 the flowrate from Section 1 rather suddenly increases to 9 L/min, while pressure decreases in several boreholes on the south side of the prototype. This is probably a result of tube failure in borehole section KA3573A:3.

## Packer functionality status in Section II

The packers are of the type PU53 or PU72. All packers have an inflation length of one meter and the minimum and maximum packer expansion pressure is 6.5 bar and 65 bar respectively. They are expanded by means of water, pressurised by nitrogen gas in a pressure vessel. A regulator controls the magnitude of the inflation pressure. The stainless steel pressure vessel is connected to the packers by a high-pressure 6/4-mm polyamide tube, type Tecalan. A check valve unit with a manometer is mounted on the packer inflation line. In order to avoid accidental deflation the check valve unit also includes a stop valve.

In *Table 6* below are listed the borehole packers that have ceased to function for some reason.



**Table 6 Packer functionality status in Section II**

Packer tube label	Borehole	Status 2006-06-01	Date of inflation pressure failure	Date of re-inflation pressure
XRA1100	KA3539G	OK		
XRA1200	KA3542G01	OK	2003-10-30	2003-11-10
XRA1300	KA3542G02	OK	2003-10-30	2003-11-10
XRA1600	KA3544G01	Not functioning due to tube leakage	2003-10-30	–
XRA1700	KA3546G01	OK		
XRA1800	KA3548A01	OK	2003-10-30	2003-11-10
XRA2000	KA3548G01	OK		
XRA2100	KA3550G01	Not functioning due to tube leakage	2003-08-18	–
XRA2200	KA3550G05	OK		
XRA2300	KA3551G05	OK		
XRA2500	KA3552G01	OK		
XRA2800	KA3554G01	OK		
XRA2900	KA3554G02	OK		
XRA3000	KA3557G	OK	ca 2005-10-01	Jan 2006

## Deformation measurements in Section II

Deformation measurements of fractures in borehole sections with Hydro-Mechanical anchors in Section II are on-going but no results are available yet.

## Flow measurements

Earlier estimations and measurements of inleaking ground water amounts to the tunnel system are presented in (*Forsmark T, Rhén I, 2001*) and (*Rhén I, Forsmark T, 2001*).

Data from eight flow weirs are presented in this data report.

A weir at the tunnel G opening measures the inleaking amounts from this tunnel. The weir was taken in operation in January 2002-01-21 and is named MG0004G. The water from MG0004G is led to PG5. The pumped water amounts from Section I mentioned above was prior to to November 1, 2004, when the drainage of Section I was closed down, included in the rates from this weir station which is clearly shown in the diagram below.

The weir MF0061G halfway down tunnel F measures today the inleaking amounts from the first half of tunnel F, see plot of this weir. Earlier, until autumn 2001, inleaking water from tunnel G was led to tunnel F and weir MF0061G thereby to some extent explaining the high flowrate during that period. The inleaking water in tunnel J+ is included in the flowrate of MF0061G.

The weir MA3426G measures the flow rates from the south part of tunnel J and tunnel A chainage 3426 – 3514 m. Until December 2003 the inleaking amounts from tunnel section 3515 – 3600 was included in the presented flowrate. The inleaking water in tunnel I is included in this weir's flowrate.

In December 2003 three new flow measurement weirs were constructed in the A-tunnel outside Section II plug. They are called MA3515G, MA3525G and MA3535G (in operation 2003-12-10). The water from these three weirs is led to MA3426G. Continuous measurement is done since the spring of 2004. Manual measurements done in december

2003 show a flowrate for MA3515G of 0.175 – 0.19 L/min, for MA3525G of 1.15 – 1.25 L/min and for MA3535G of 0.38 – 0.45 L/min. The increase of flow during October 2004 was caused by yet unknown causes, but it is believed that the final grouting that was done around Plug 2 October 8, 2004 is the cause to it. The flow rates have now decreased once again.

Two weirs have, during the winter 2004/2005, been constructed inside niches I and J+. They are called MI0008G (in operation 2005-01-20) and MJ0033G (in operation 2005-01-20) respectively. The water from MI0008G is led to MA3426G. The water from MJ0033G is led to MF0061G. MI0008G is included in the continuously measurement program (HMS) while MJ0033G is measured manually approximately every fortnight. The readings from MI0008G have however not been correct since August 2005 and therefor no readings are presented since then. Manual readings will be made in the future. A manual reading 2006-06-26 shows a flow of 2.85 L/min which is within the same order of magnitude as the flow readings of the pre-August 2005 period.

## Water sampling

Water sampling for chemical analysis have been done at several occasions, see *Table 7*. Each one of them may have an short-lived effect on the hydrostatic pressure in the rockmass. In some cases the flowing of a section continued for several days and the following pressure response is clearly shown in the subsequent plot.

**Table 7 Water sampling dates in boreholes close to the Prototype Repository. Start and stop of times are for the flowing of the section.**

Borehole	Start date/time	Stop date/time	Secup	Seclow	Section number
KA3600F	2001-10-15 10:30:00	2001-10-15 10:45:00	40.50	42.00	2
KA3600F	2001-10-15 10:45:00	2001-10-15 11:15:00	43.00	50.10	1
KA3573A	2002-09-24 10:30:00	2002-09-24 11:00:00	26.00	40.07	1
KA3573A	2002-09-24 11:40:00	2002-09-24 13:40:00	21.00	24.00	2
KA3600F	2002-09-25 11:00:00	2002-09-25 13:40:00	40.50	42.00	2
KA3600F	2002-09-25 11:25:00	2002-09-25 11:44:00	43.00	50.01	1
KA3510A	2002-12-12 08:30:00	2002-12-12 08:50:00	4.50	50.00	5
KA3510A	2002-12-12 08:30:00	2002-12-12 08:52:00	110.00	124.00	2
KA3510A	2002-12-12 10:30:00	2002-12-12 11:04:00	75.00	109.00	3
KA3539G	2003-05-23 09:48:00	2003-05-23 09:53:00	15.85	17.60	2
KA3542G01	2003-06-02 09:28:00	2003-06-02 09:54:00	18.60	20.30	3
KA3548A01	2003-06-02 09:57:00	2003-06-02 10:15:00	8.80	10.75	3
KG0048A01	2003-06-03 10:06:00	2003-06-03 10:12:00	32.80	33.80	3
KA3554G01	2003-06-03 10:31:00	2003-06-03 10:38:00	22.60	24.15	2
KA3542G02	2003-06-04 11:09:00	2003-06-04 12:49:00	25.60	27.20	2
KA3566G02	2003-06-04 12:30:00	2003-06-04 17:30:00	16.00	18.00	2
KG0021A01	2003-06-30 11:03:00	2003-06-30 11:09:00	35.00	36.00	3
KA3554G02	2003-06-30 15:23:00	2003-06-30 21:40:00	10.50	12.20	4
KA3600F	2003-07-03 13:51:00	2003-07-03 13:53:00	40.50	42.00	2
KA3572G01	2003-08-11 15:28:00	2003-08-28 15:00:00	2.70	5.30	2

Borehole	Start date/time	Stop date/time	Secup	Seclow	Section number
KG0021A01	2003-09-18 09:40:00	2003-09-18 09:55:00	35.00	36.00	3
KG0048A01	2003-09-18 09:45:00	2003-09-18 09:55:00	32.80	33.80	3
KA3542G01	2003-09-24 09:15:00	2003-09-24 09:30:00	18.60	20.30	3
KA3539G	2003-09-24 09:20:00	2003-09-24 09:35:00	15.85	17.60	2
KA3548A01	2003-09-24 09:30:00	2003-09-24 10:00:00	8.80	10.75	3
KA3554G01	2003-09-24 09:30:00	2003-09-24 10:00:00	22.60	24.15	2
KA3573A	2003-09-25 09:00:00	2003-09-25 10:00:00	26.00	40.07	1
KA3600F	2003-09-25 09:00:00	2003-09-25 09:45:00	43.00	50.10	1
KA3600F	2003-09-25 09:30:00	2003-09-25 10:00:00	40.50	42.00	2
KA3542G02	2003-09-26 11:20:00	2003-09-26 11:35:00	2.00	8.00	5
KA3573A	2003-09-29 10:20:00	2003-09-29 10:40:00	21.00	24.00	2
KA3566G02	2003-09-29 11:00:00	2003-09-29 13:50:00	16.00	18.00	2
KA3590G01	2003-09-30 09:00:00	2003-09-30 12:45:00	16.00	30.00	2
KA3539G	2004-02-16 10:50:00	2004-03-22 11:26:00	15.85	17.60	2
KA3548A01	2004-02-16 12:13:00	2004-02-16 12:31:00	8.80	10.75	3
KA3600F	2004-02-17 09:55:00	2004-02-17 10:11:00	40.50	42.00	2
KG0021A01	2004-02-17 10:27:00	2004-02-17 10:43:00	35.00	36.00	3
KA3539G	2004-02-17 11:30:00	2004-02-17 11:31:00	15.85	17.60	2
KG0048A01	2004-03-02 09:24:00	2004-03-02 09:40:00	32.80	33.80	3
KA3554G01	2004-03-02 10:04:00	2004-03-02 10:17:00	22.60	24.15	2
KA3542G02	2004-03-02 10:22:00	2004-03-02 13:15:00	2.80	8.00	5
KA3590G01	2004-03-03 21:36:00	2004-03-03 21:36:00	7.00	15.00	2
KA3572G01	2004-04-02 10:35:00	2004-04-07 10:15:00	2.70	5.30	2
KA3573A	2004-09-21 09:23:00	2004-09-22 09:54:00	26.00	40.07	1
KA3600F	2004-09-21 09:23:00	2004-09-22 10:03:00	43.00	50.10	1
KA3573A	2004-09-22 09:2200	2004-09-22 10:03:00	21.00	24.00	2
KA3600F	2004-09-22 09:18:00	2004-09-22 09:44:00	40.50	42.00	2
KA3542G01	2004-11-09 09:02:00	2004-11-09 10:11:00	18.60	20.30	3
KA3590G01	2004-11-15 11:16	2005-01-20 09:40	7.00	15.00	2
KA3554G02	2004-11-19 08:30:00	2004-11-22 16:50:00	10.50	12.20	4
KA3566G02	2004-11-19 08:30:00	2004-11-22 09:53:00	16.00	18.00	2
KA3566G02	2005-02-03 10:20	2005-03-10 14:00	16.00	18.00	2
KA3573A	2005-09-26 10:5800	2005-09-26 10:58:00	21.00	24.00	2
KA3600F	2005-09-26 10:42:00	2005-09-26 10:42:00	40.50	42.00	2
KA3510A	2005-10-03 09:24:00	2005-10-03 09:29:00	110.00	124.00	2
KA3573A	2005-10-04 11:24:00	2005-10-05 11:05:00	26.00	40.07	1
KA3600F	2005-10-06 13:44:00	2005-10-07 10:03:00	43.00	50.10	1
KA3510A	2005-10-07 12:15:00	2005-10-07 12:38:00	110.00	124.00	2

On November 24 2005 water sampling were done in several boreholes.

## References

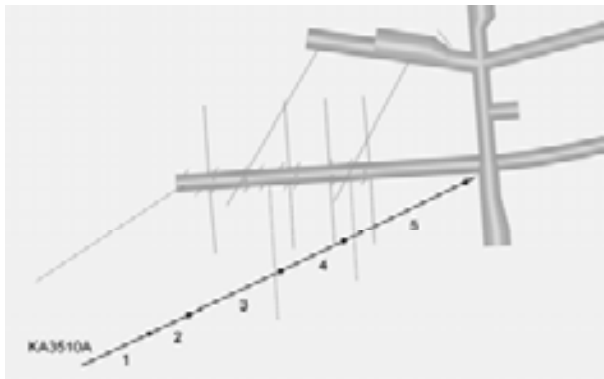
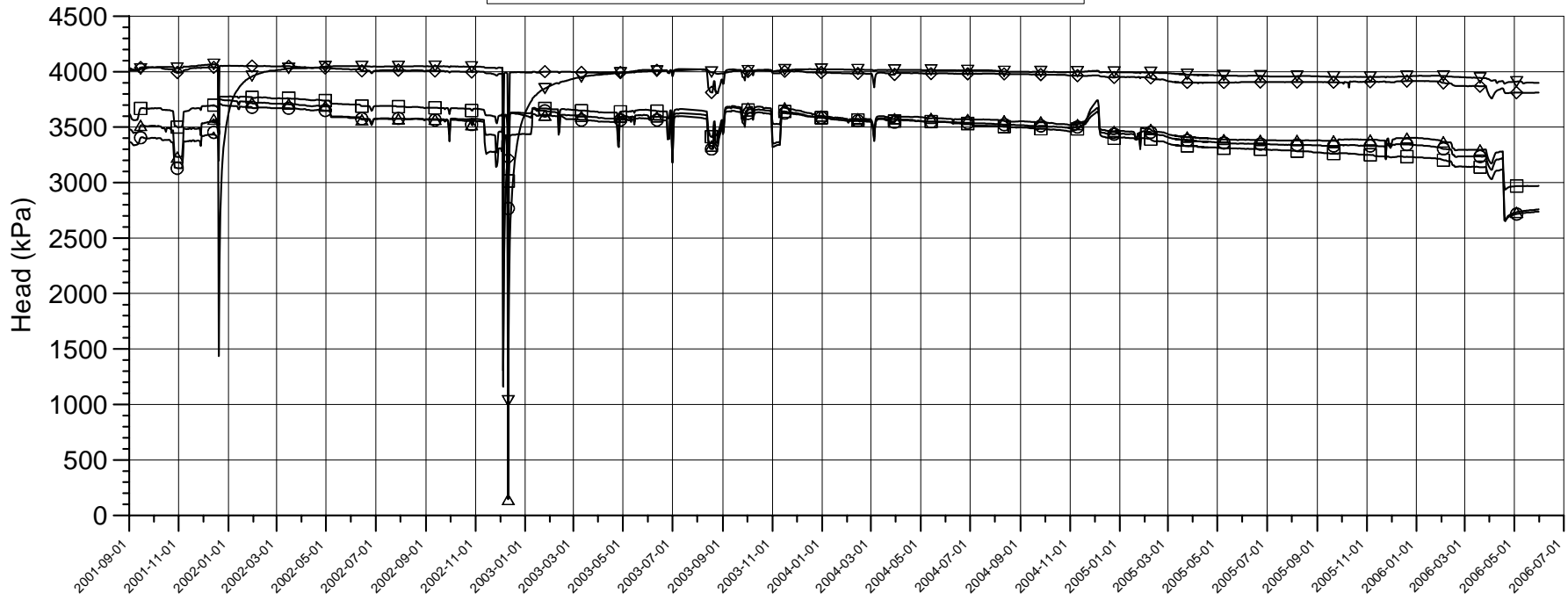
**Forsmark T, Rhén I, 2001.** Äspö HRL – Prototype repository. Hydrogeology - Injection test campaign 2. flow measurement of DA3575G01, groundwater salinity, ground water leakage into G-, I- and J-tunnels. SKB IPR-01-31.

**Rhén I, Forsmark T, Torin L, 2001.** Äspö HRL – Prototype repository. Hydrogeological, hydrochemical and temperature measurements in boreholes during the operation phase of the prototype repository. Tunnel section I. SKB IPR-01-32.

**Rhén I, Forsmark T, Magnusson J, Alm P, 2003.** Äspö HRL – Prototype repository. Hydrogeological, hydrochemical, hydromechanical and temperature measurements in boreholes during the operation phase of the prototype repository. Tunnel section II. SKB IPR-03-22.

**Rhén I, Forsmark T, 2001.** Äspö HRL – Prototype repository. Hydrogeology, Summary report of investigations before the operation phase. SKB IPR-01-65.

# KA3510A PRESSURE HEAD



## Events

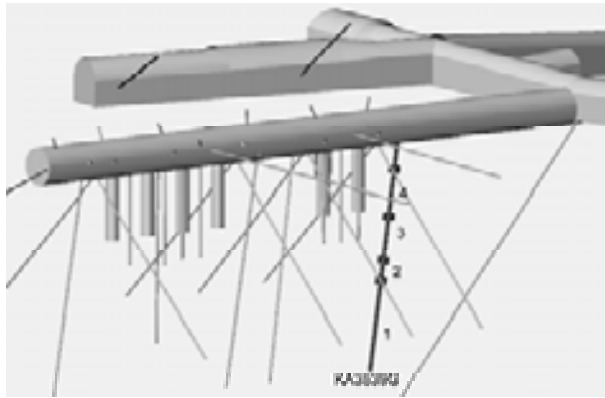
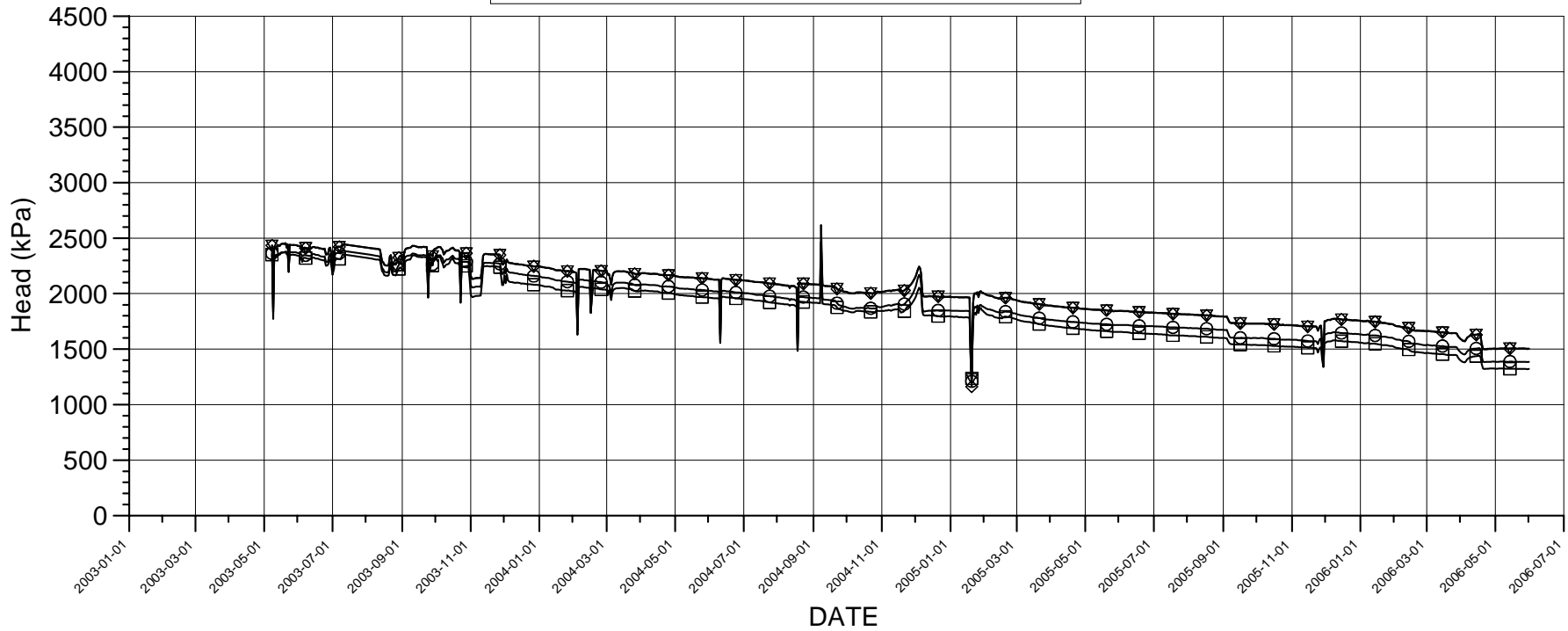
- Start backfilling of section I 2001-09-03
- Stop backfilling of section I 2001-11-20
- Casting of inner plug finalized 2001-12-19
- Start backfilling of section II 2003-04-29
- Stop backfilling of section II 2003-06-27
- Casting of outer plug finalized 2003-09-11

## Borehole sections

- ▽ A:1 125 m - 150 m
- ◇ A:2 110 m - 124 m
- A:3 75 m - 109 m
- A:4 51 m - 74 m
- △ A:5 4.5 m - 50 m

P\_KA3510A.GRF 2006-06-07

# KA3539G PRESSURE HEAD



## Events

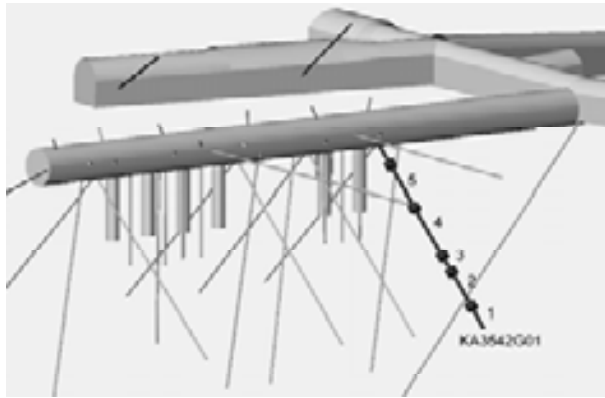
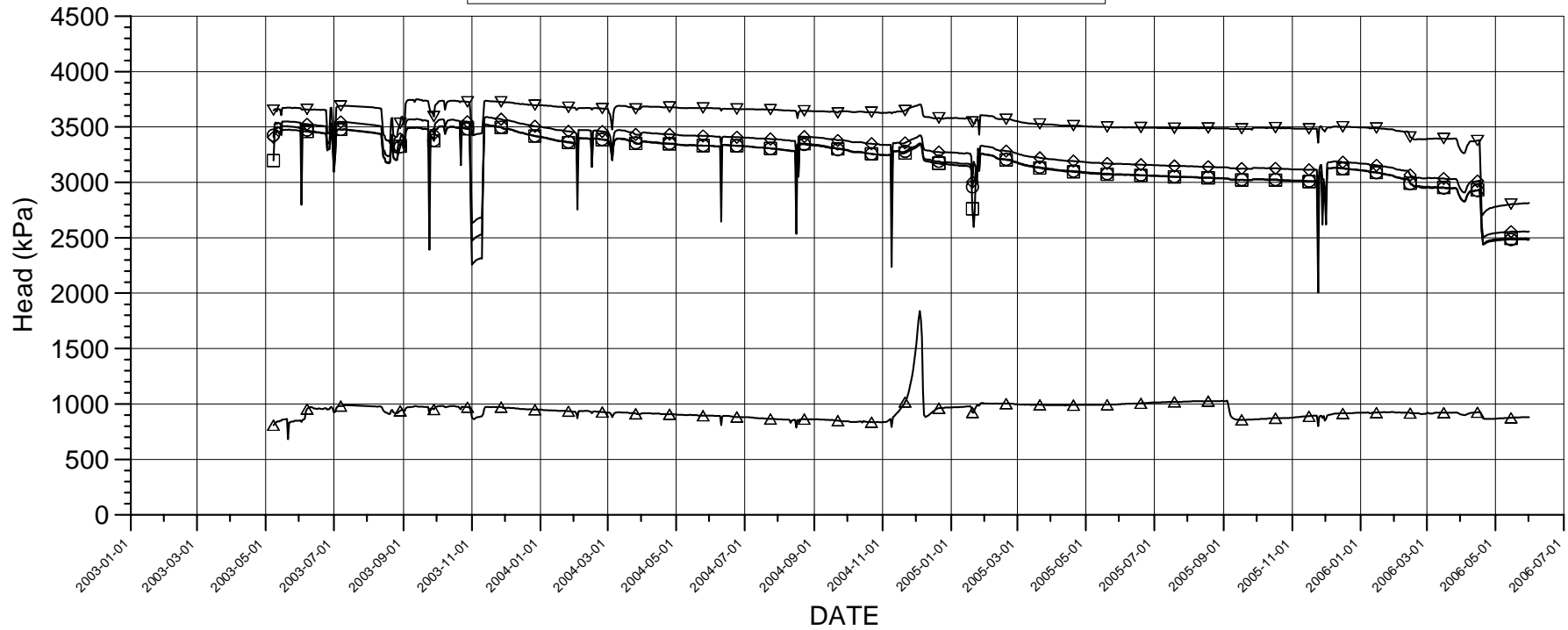
- Start backfilling of section I 2001-09-03
- Stop backfilling of section I 2001-11-20
- Casting of inner plug finalized 2001-12-19
- Start backfilling of section II 2003-04-29
- Stop backfilling of section II 2003-06-27
- Casting of outer plug finalized 2003-09-11

## Borehole sections

- ▽ — ▽ G:1 18.6 m - 30 m
- ◇ — ◇ G:2 15.85 m - 17.6 m
- — □ G:3 10 m - 14.85 m
- — ○ G:4 4 m - 9 m

P\_KA3539G.GRF 2006-06-07

# KA3542G01 PRESSURE HEAD



## Events

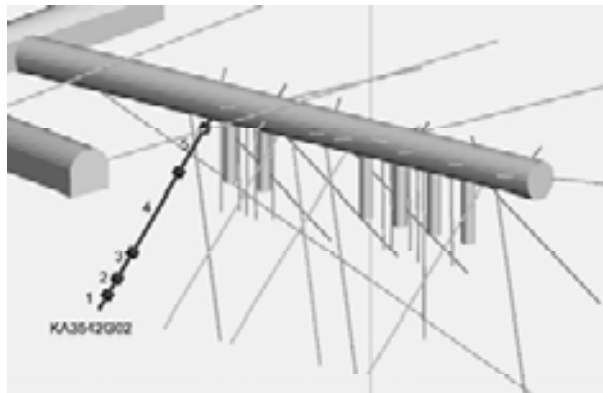
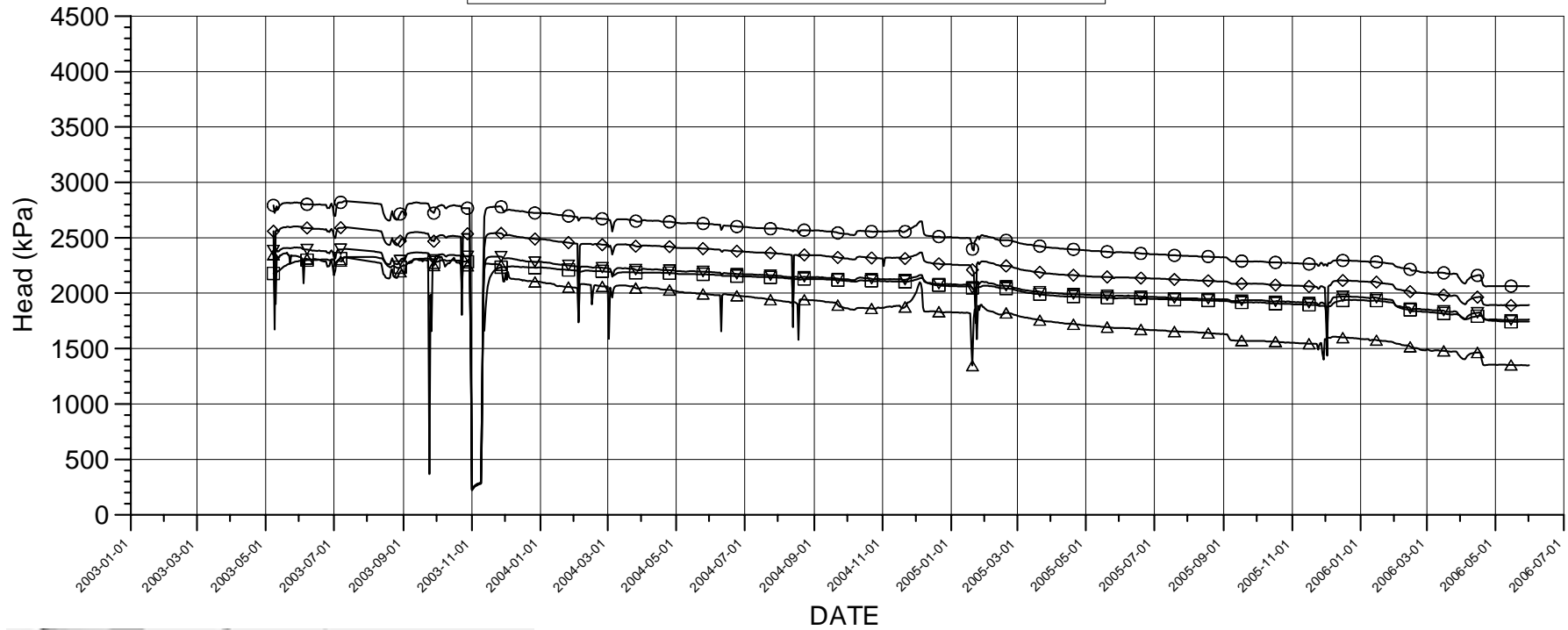
- Start backfilling of section I 2001-09-03
- Stop backfilling of section I 2001-11-20
- Casting of inner plug finalized 2001-12-19
- Start backfilling of section II 2003-04-29
- Stop backfilling of section II 2003-06-27
- Casting of outer plug finalized 2003-09-11

## Borehole sections

- ▽ — ▽ G01:1 27 m - 30 m
- ◇ — ◇ G01:2 21.3 m - 26 m
- — □ G01:3 18.6 m - 20.3 m
- — ○ G01:4 10.5 m - 17.6 m
- △ — △ G01:5 3.5 m - 9.5 m

P\_KA3542G01.GRF 2006-06-07

# KA3542G02 PRESSURE HEAD



## Events

- Start backfilling of section I 2001-09-03
- Stop backfilling of section I 2001-11-20
- Casting of inner plug finalized 2001-12-19
- Start backfilling of section II 2003-04-29
- Stop backfilling of section II 2003-06-27
- Casting of outer plug finalized 2003-09-11

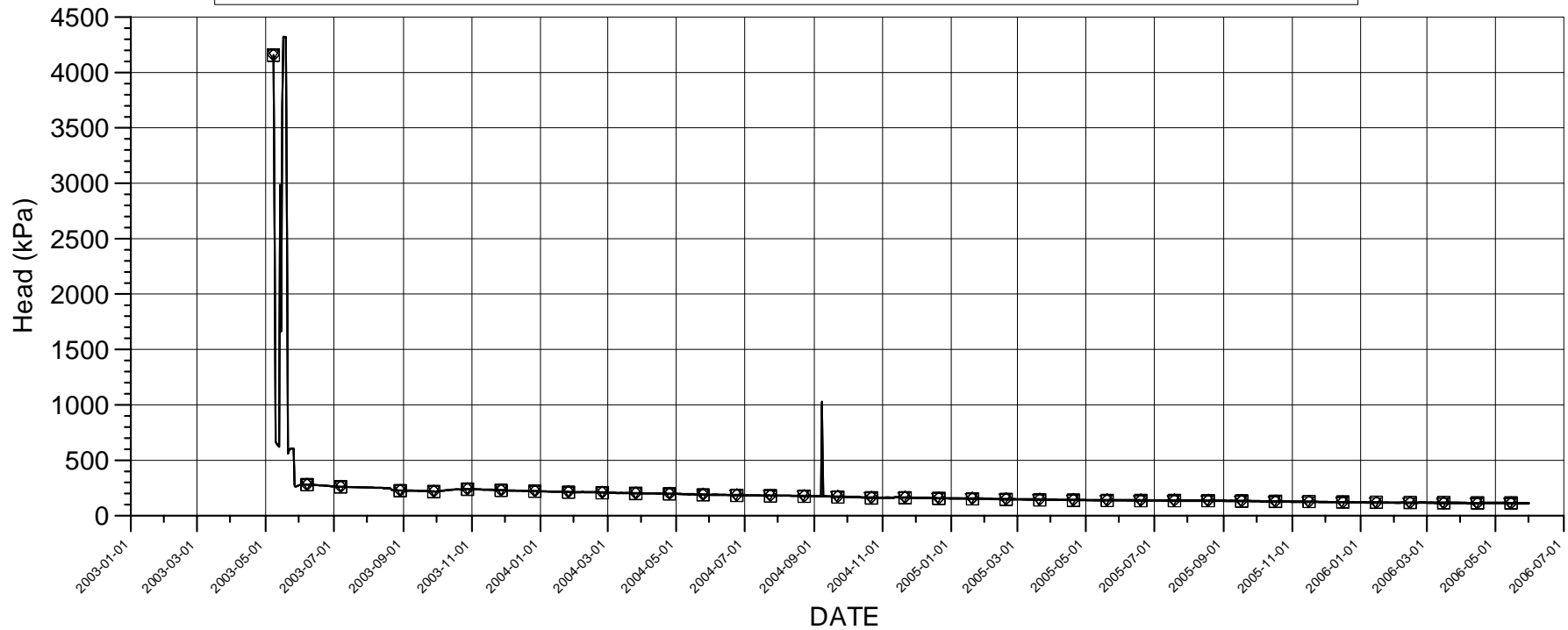
## Borehole sections

- ▽ — ▽ G02:1 28.2 m - 30.01 m
- ◇ — ◇ G02:2 25.6 m - 27.2 m
- — □ G02:3 21.5 m - 24.6 m
- — ○ G02:4 9 m - 20.5 m
- △ — △ G02:5 2 m - 8 m

P\_KA3542G02.GRF 2006-06-07



# KA3543A01, KA3543I01, KA3548D01 PRESSURE HEAD



## Events

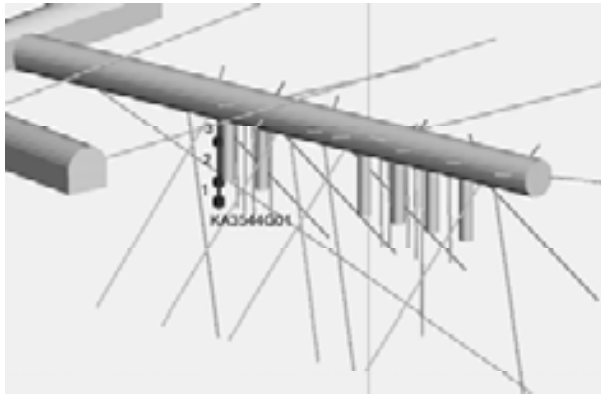
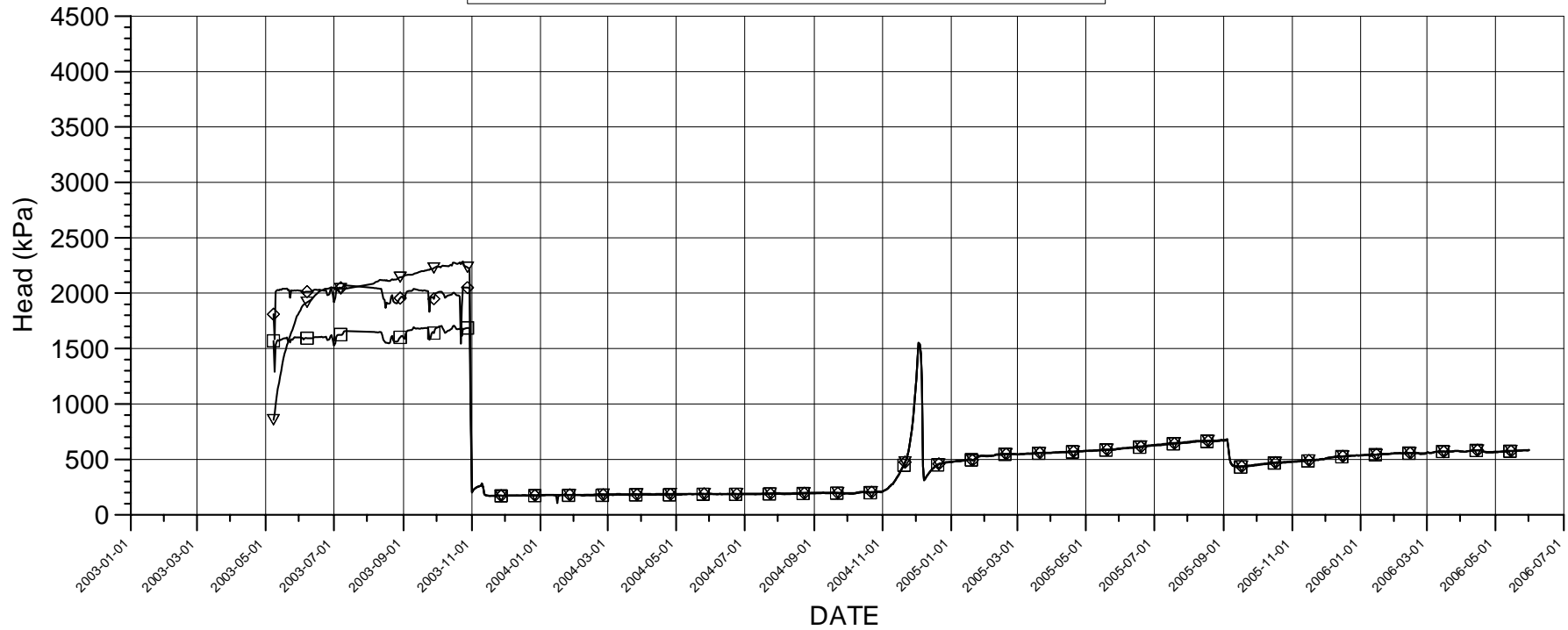
- Start backfilling of section I 2001-09-03
- Stop backfilling of section I 2001-11-20
- Casting of inner plug finalized 2001-12-19
- Start backfilling of section II 2003-04-29
- Stop backfilling of section II 2003-06-27
- Casting of outer plug finalized 2003-09-11

## Borehole sections

- ▽ KA3543A01:1 0.65 m - 2 m
- ◇ KA3543I01:1 0.65 m - 2 m
- KA3548D01:1 0.65 m - 2 m

P\_KA3543A01-P\_KA3548D01.GRF 2006-06-07

# KA3544G01 PRESSURE HEAD



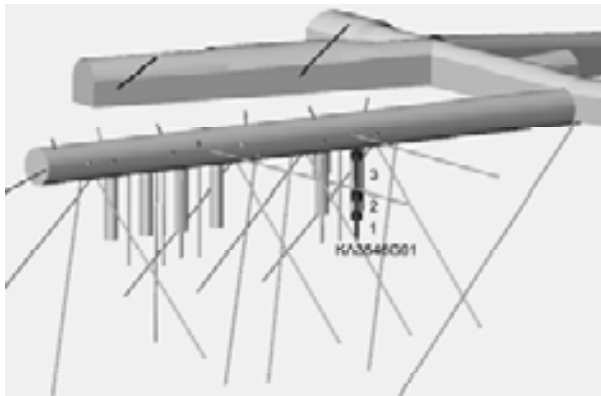
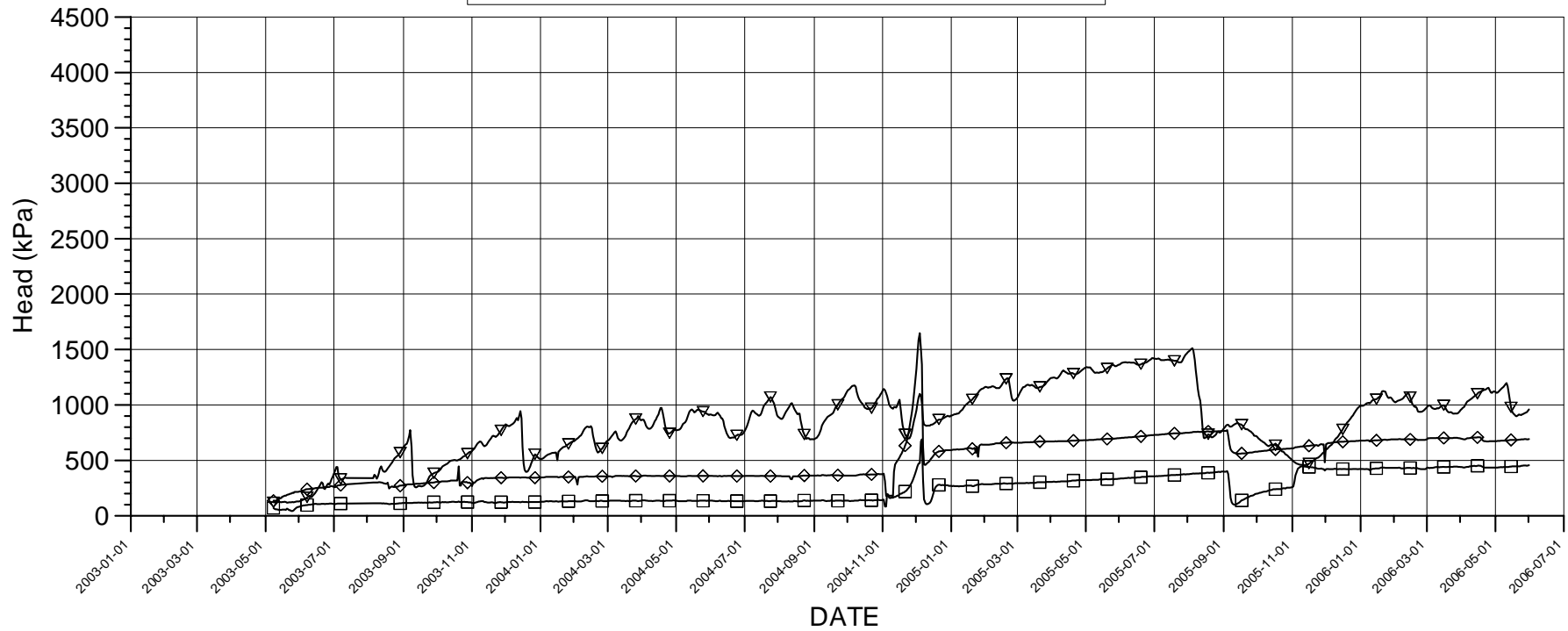
## Events

- Start backfilling of section I 2001-09-03
- Stop backfilling of section I 2001-11-20
- Casting of inner plug finalized 2001-12-19
- Start backfilling of section II 2003-04-29
- Stop backfilling of section II 2003-06-27
- Casting of outer plug finalized 2003-09-11

## Borehole sections

- ▽ — ▽ G01:1 11.65 m - 12 m
- ◇ — ◇ G01:2 8.9 m - 10.65 m
- — □ G01:3 3.5 m - 7.9 m

# KA3546G01 PRESSURE HEAD



## Events

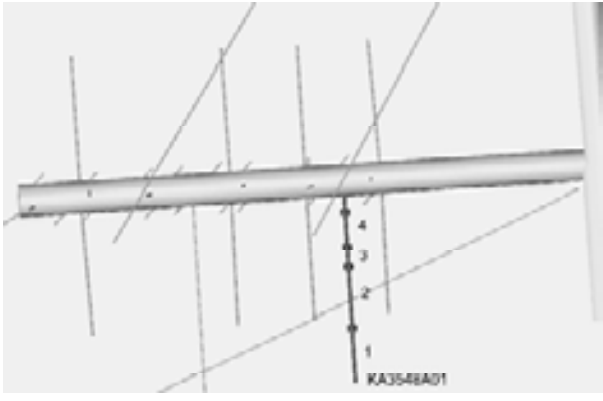
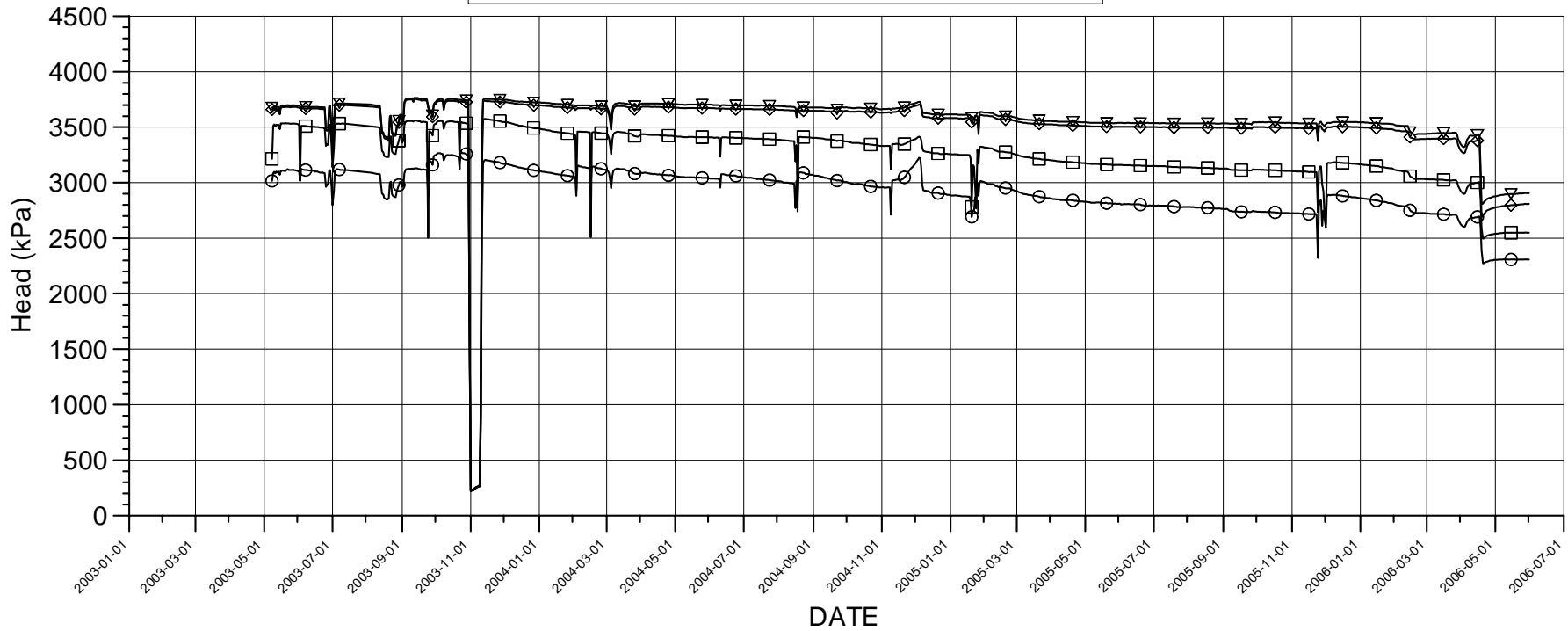
- Start backfilling of section I 2001-09-03
- Stop backfilling of section I 2001-11-20
- Casting of inner plug finalized 2001-12-19
- Start backfilling of section II 2003-04-29
- Stop backfilling of section II 2003-06-27
- Casting of outer plug finalized 2003-09-11

## Borehole sections

- ▽ — ▽ G01:1 9.3 m - 12 m
- ◇ — ◇ G01:2 6.75 m - 8.3 m
- — □ G01:3 1.5 m - 5.75 m

P\_KA3546G01.GRF 2006-06-07

# KA3548A01 PRESSURE HEAD



## Events

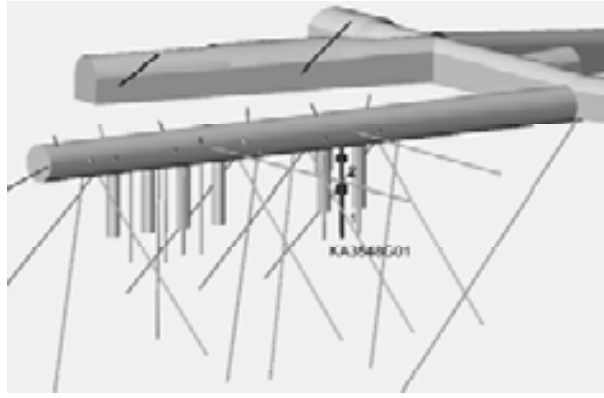
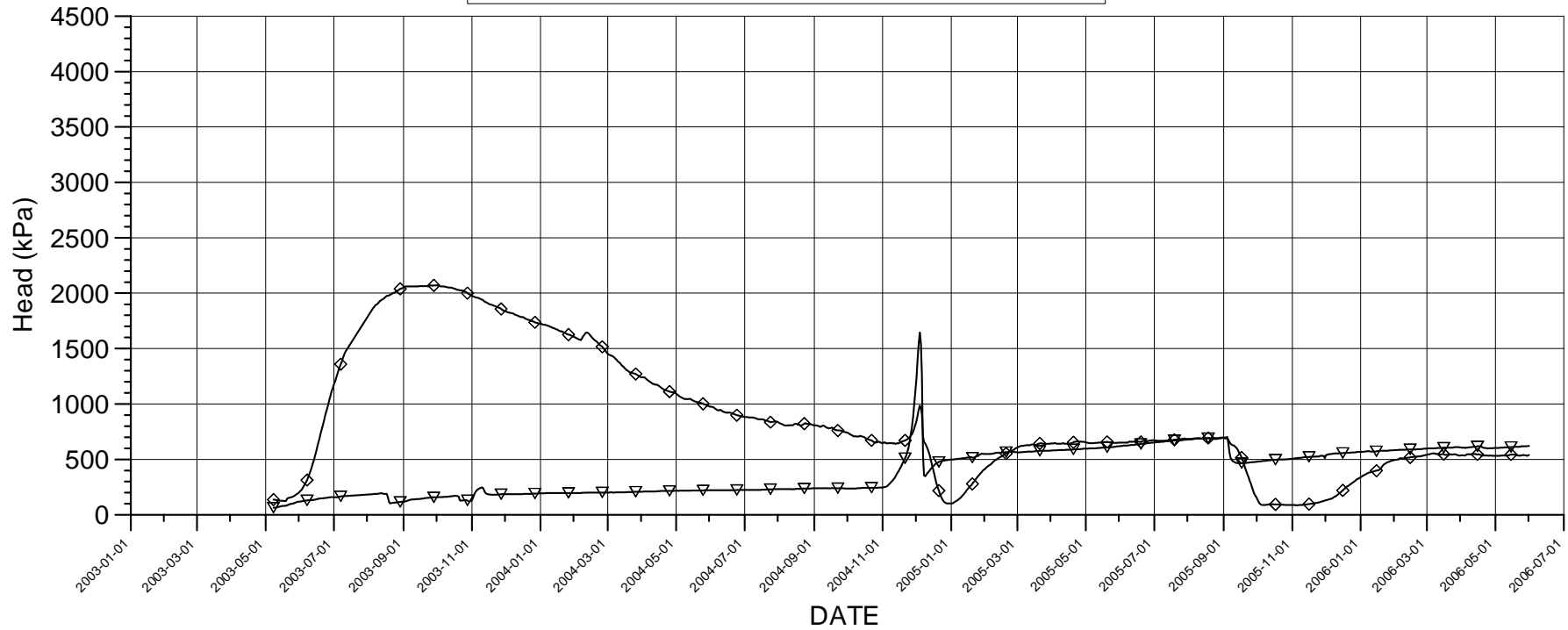
- Start backfilling of section I 2001-09-03
- Stop backfilling of section I 2001-11-20
- Casting of inner plug finalized 2001-12-19
- Start backfilling of section II 2003-04-29
- Stop backfilling of section II 2003-06-27
- Casting of outer plug finalized 2003-09-11

## Borehole sections

- ▽ A01:1 21.5 m - 30 m
- ◇ A01:2 11.75 m - 20.5 m
- A01:3 8.8 m - 10.75 m
- A01:4 3 m - 7.8 m

P\_KA3548A01.GRF 2006-06-07

# KA3548G01 PRESSURE HEAD



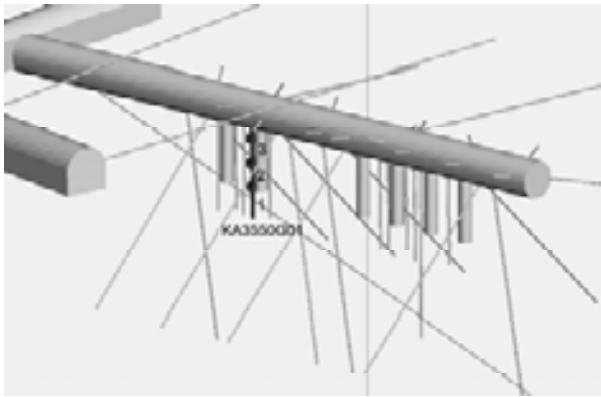
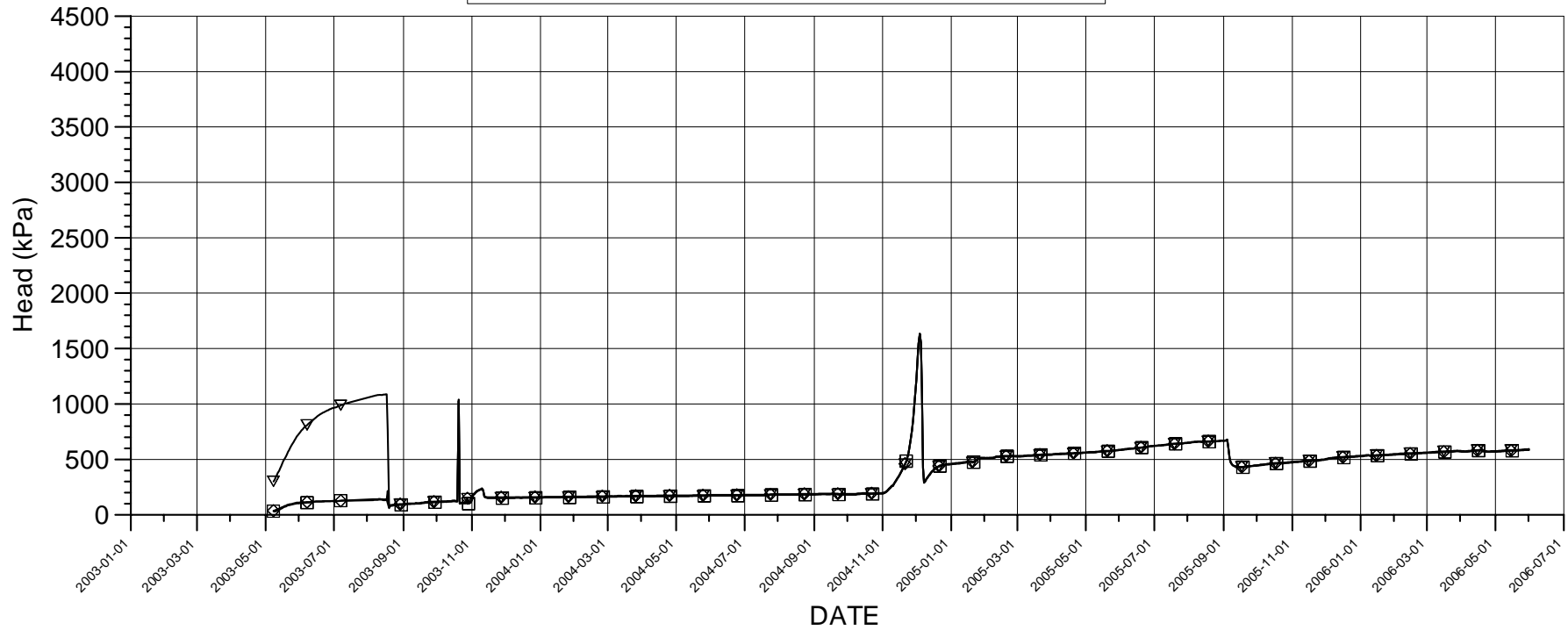
## Events

- Start backfilling of section I 2001-09-03
- Stop backfilling of section I 2001-11-20
- Casting of inner plug finalized 2001-12-19
- Start backfilling of section II 2003-04-29
- Stop backfilling of section II 2003-06-27
- Casting of outer plug finalized 2003-09-11

## Borehole sections

- ▽ — ▽ G01:1 6 m - 12 m
- ◇ — ◇ G01:2 2 m - 5 m

# KA3550G01 PRESSURE HEAD



## Events

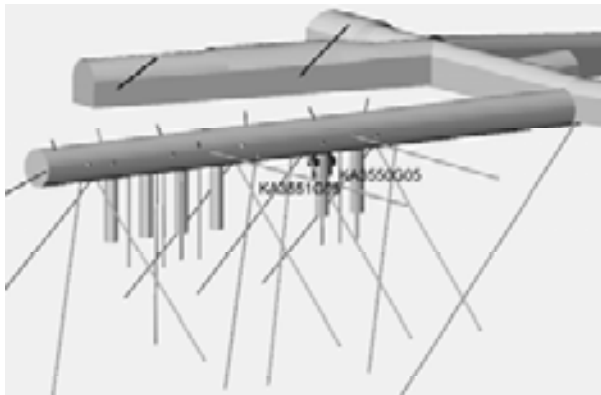
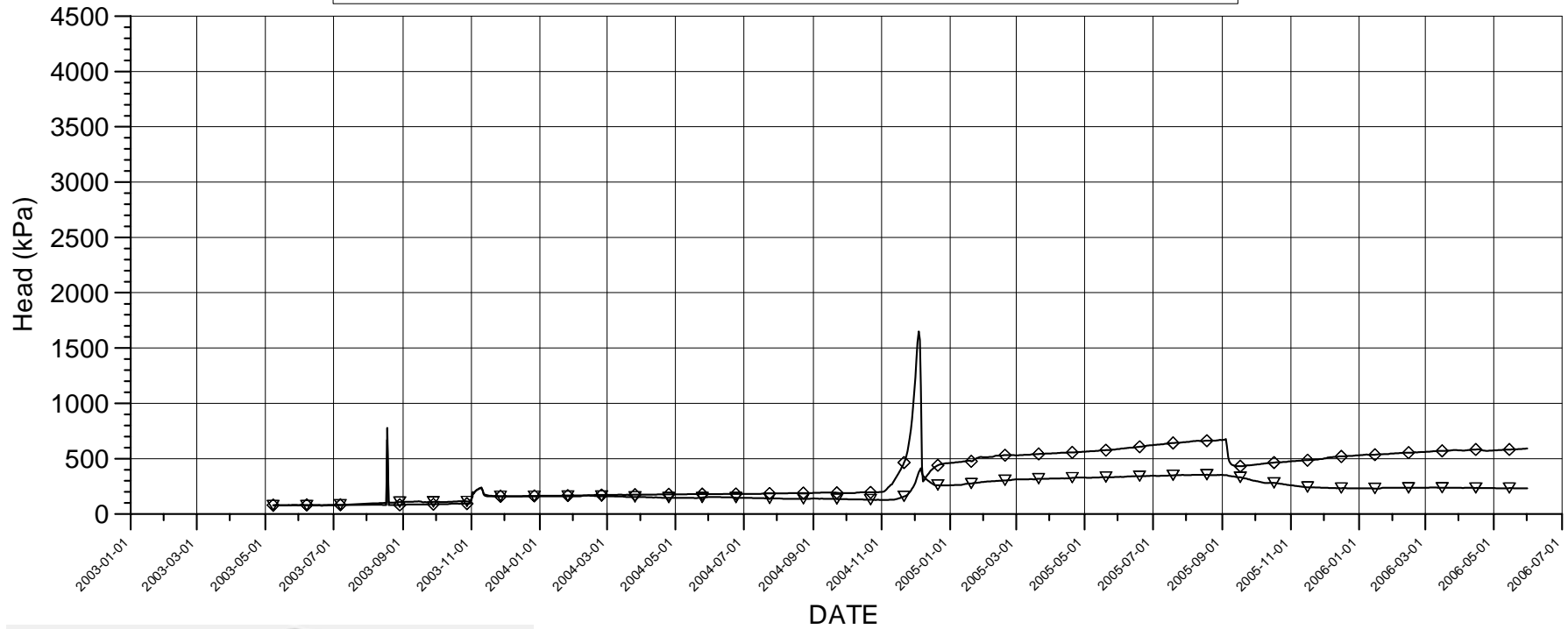
- Start backfilling of section I 2001-09-03
- Stop backfilling of section I 2001-11-20
- Casting of inner plug finalized 2001-12-19
- Start backfilling of section II 2003-04-29
- Stop backfilling of section II 2003-06-27
- Casting of outer plug finalized 2003-09-11

## Borehole sections

- ▽ — ▽ G01:1 8.3 m - 12.03 m
- ◇ — ◇ G01:2 5.2 m - 7.3 m
- — □ G01:3 1.8 m - 4.2 m

P\_KA3550G01.GRF 2006-06-07

## KA3550G05, KA3551G05 PRESSURE HEAD



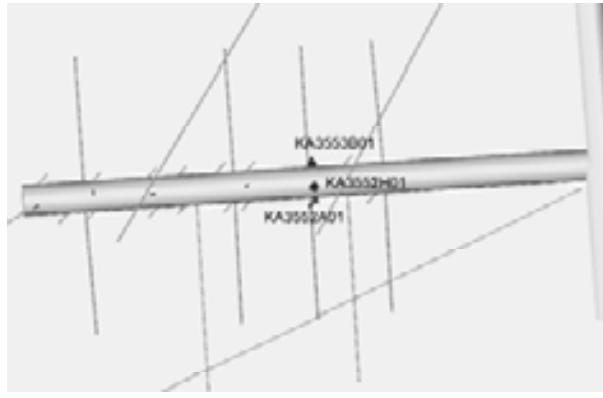
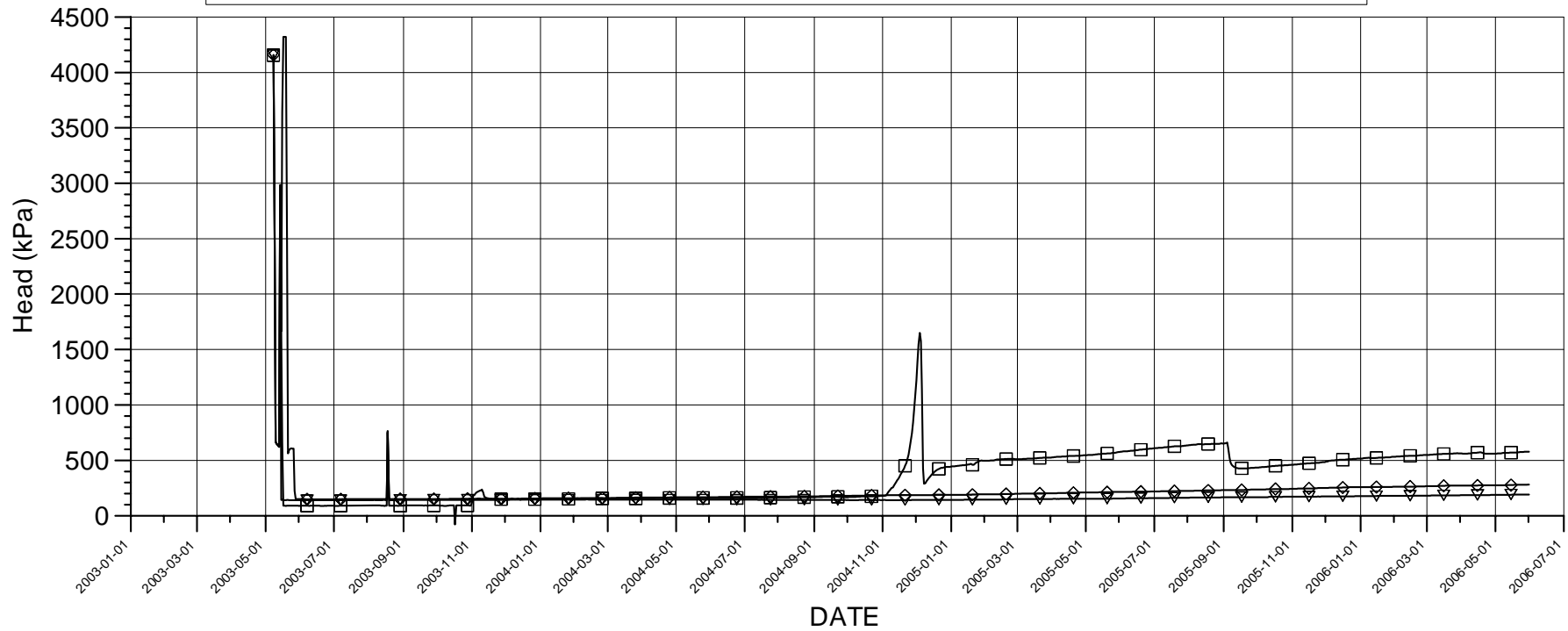
### Events

- Start backfilling of section I 2001-09-03
- Stop backfilling of section I 2001-11-20
- Casting of inner plug finalized 2001-12-19
- Start backfilling of section II 2003-04-29
- Stop backfilling of section II 2003-06-27
- Casting of outer plug finalized 2003-09-11

### Borehole sections

- ▽ KA3550G05:1 1.5 m - 3 m
- ◇ KA3551G05:1 1.5 m - 3.1 m

# KA3552A01, KA3552H01, KA3553B01 PRESSURE HEAD



**Events**

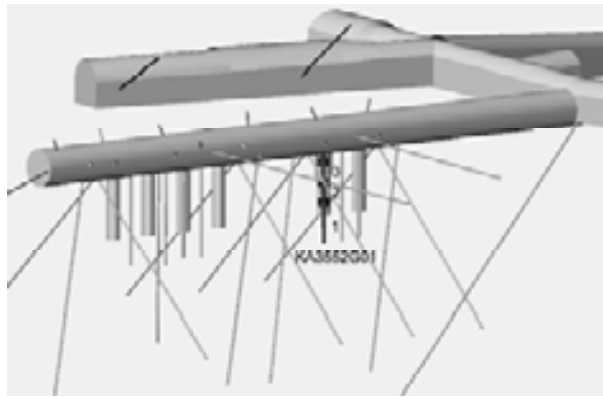
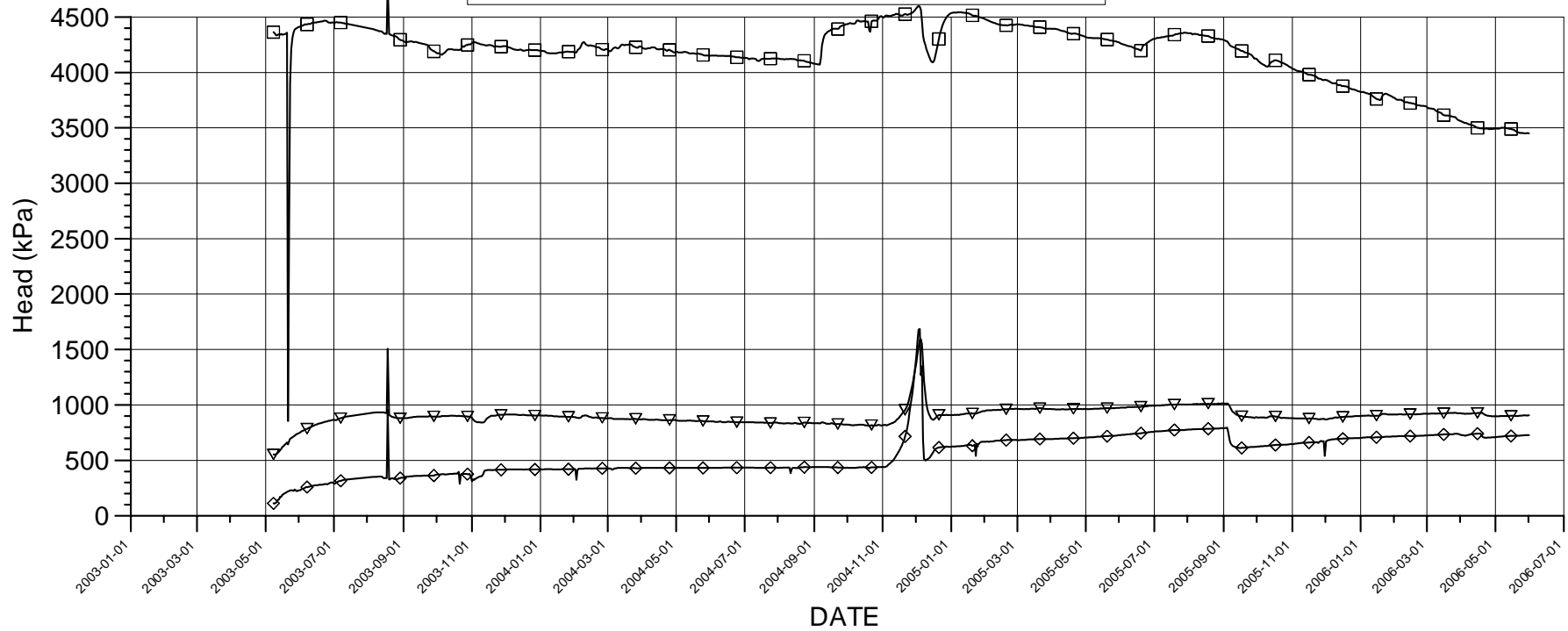
- Start backfilling of section I 2001-09-03
- Stop backfilling of section I 2001-11-20
- Casting of inner plug finalized 2001-12-19
- Start backfilling of section II 2003-04-29
- Stop backfilling of section II 2003-06-27
- Casting of outer plug finalized 2003-09-11

**Borehole sections**

- ▽ — ▽ KA3552A01:1 0.65 m - 2 m
- ◇ — ◇ KA3552H01:1 0.65 m - 2 m
- — □ KA3553B01:1 0.65 m - 2 m



# KA3552G01 PRESSURE HEAD



## Events

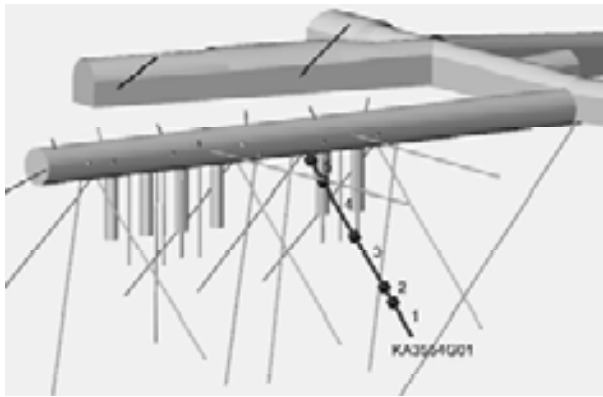
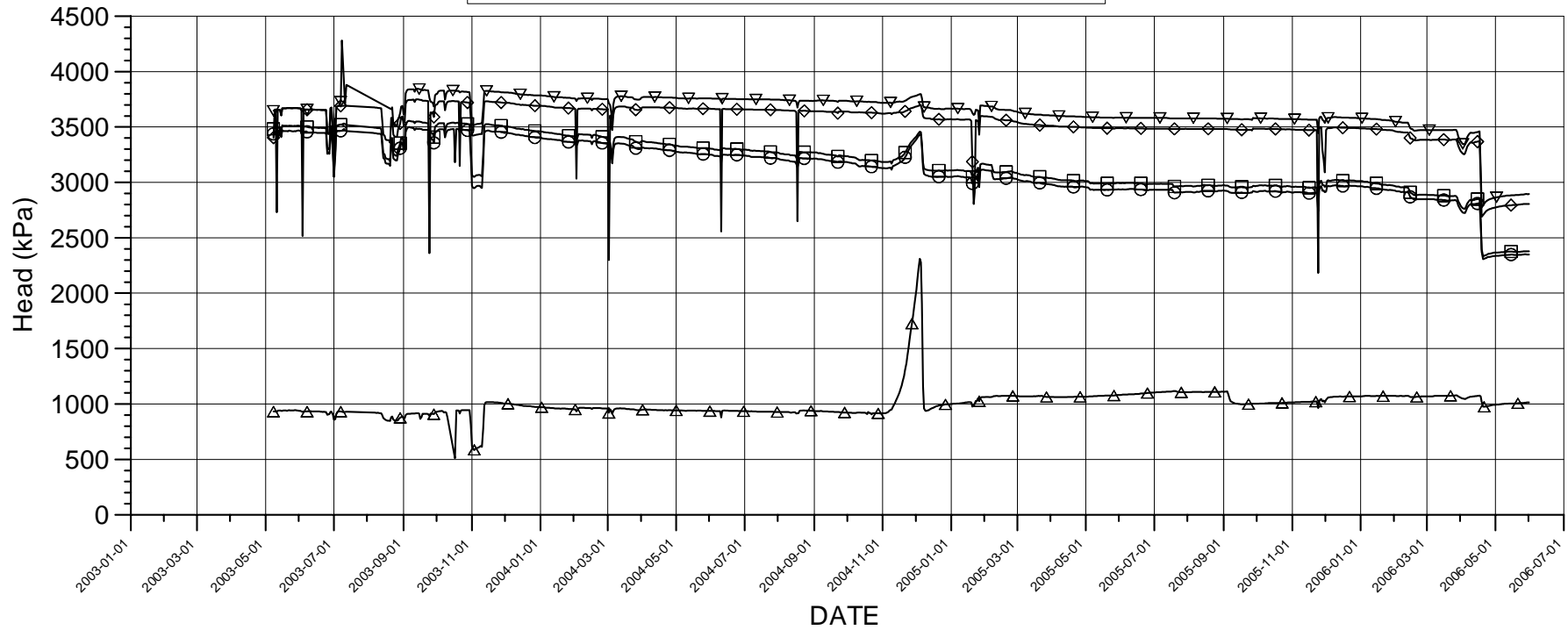
- Start backfilling of section I 2001-09-03
- Stop backfilling of section I 2001-11-20
- Casting of inner plug finalized 2001-12-19
- Start backfilling of section II 2003-04-29
- Stop backfilling of section II 2003-06-27
- Casting of outer plug finalized 2003-09-11

## Borehole sections

- ▽ — ▽ G01:1 7.05 m - 12 m
- ◇ — ◇ G01:2 4.35 m - 6.05 m
- — □ G01:3 1.5 m - 3.35 m

P\_KA3552G01.GRF 2006-06-07

# KA3554G01 PRESSURE HEAD



## Events

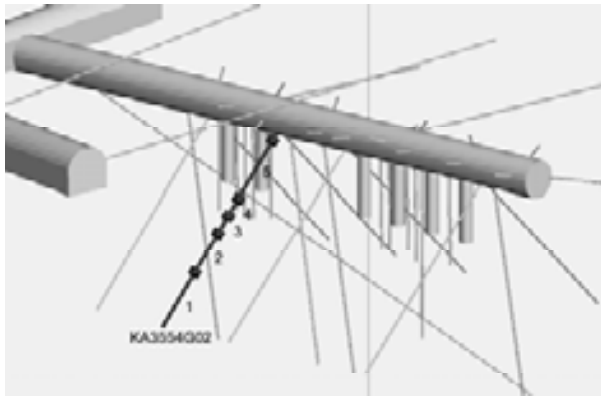
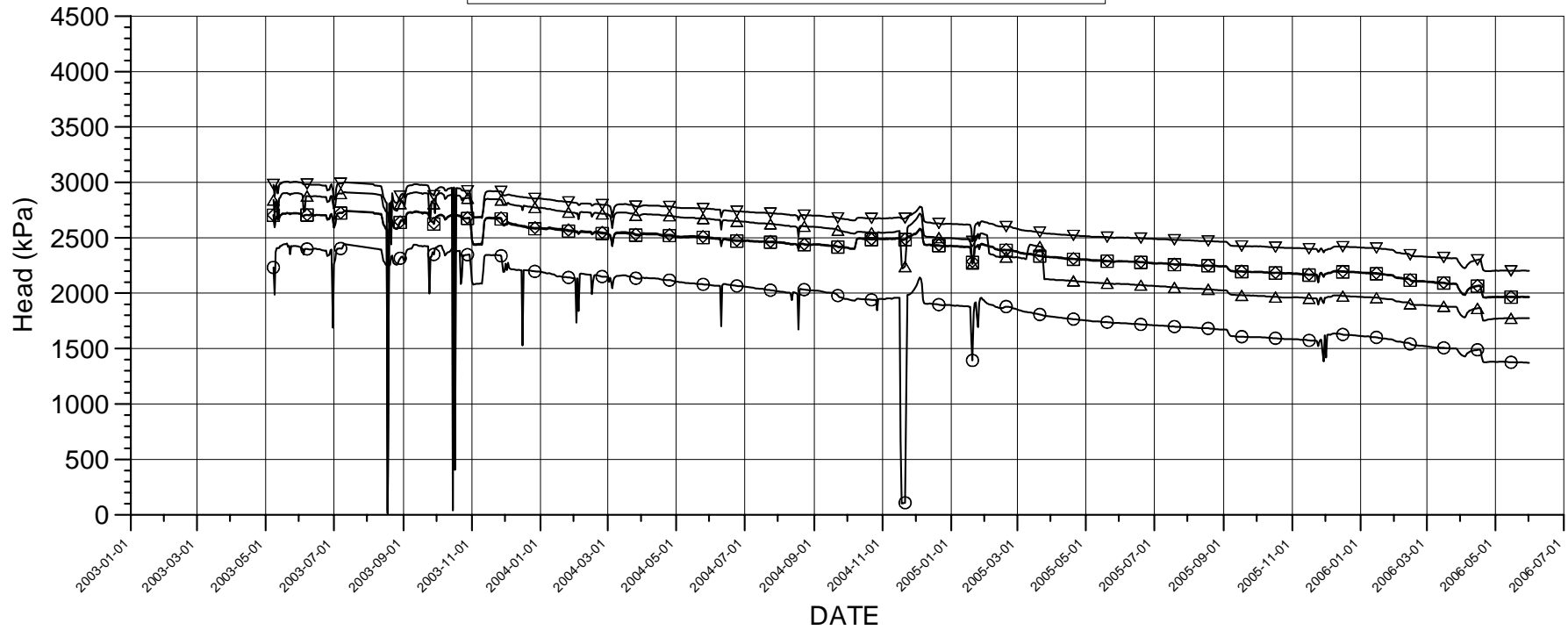
- Start backfilling of section I 2001-09-03
- Stop backfilling of section I 2001-11-20
- Casting of inner plug finalized 2001-12-19
- Start backfilling of section II 2003-04-29
- Stop backfilling of section II 2003-06-27
- Casting of outer plug finalized 2003-09-11

## Borehole sections

- ▽ — ▽ G01:1 25.15 m - 30.01 m
- ◇ — ◇ G01:2 22.6 m - 24.15 m
- — □ G01:3 14 m - 21.6 m
- — ○ G01:4 5 m - 13 m
- △ — △ G01:5 1.5 m - 4 m

P\_KA3554G01.GRF 2006-06-07

# KA3554G02 PRESSURE HEAD



## Events

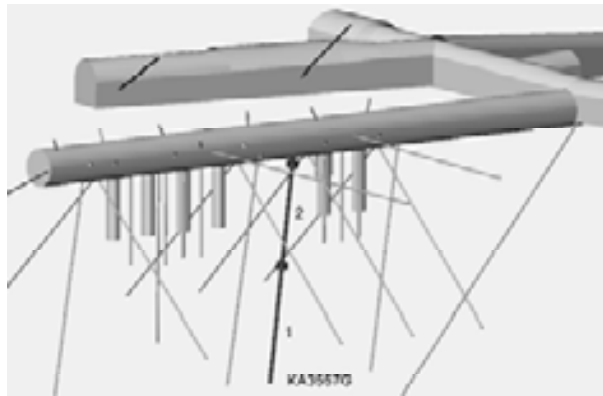
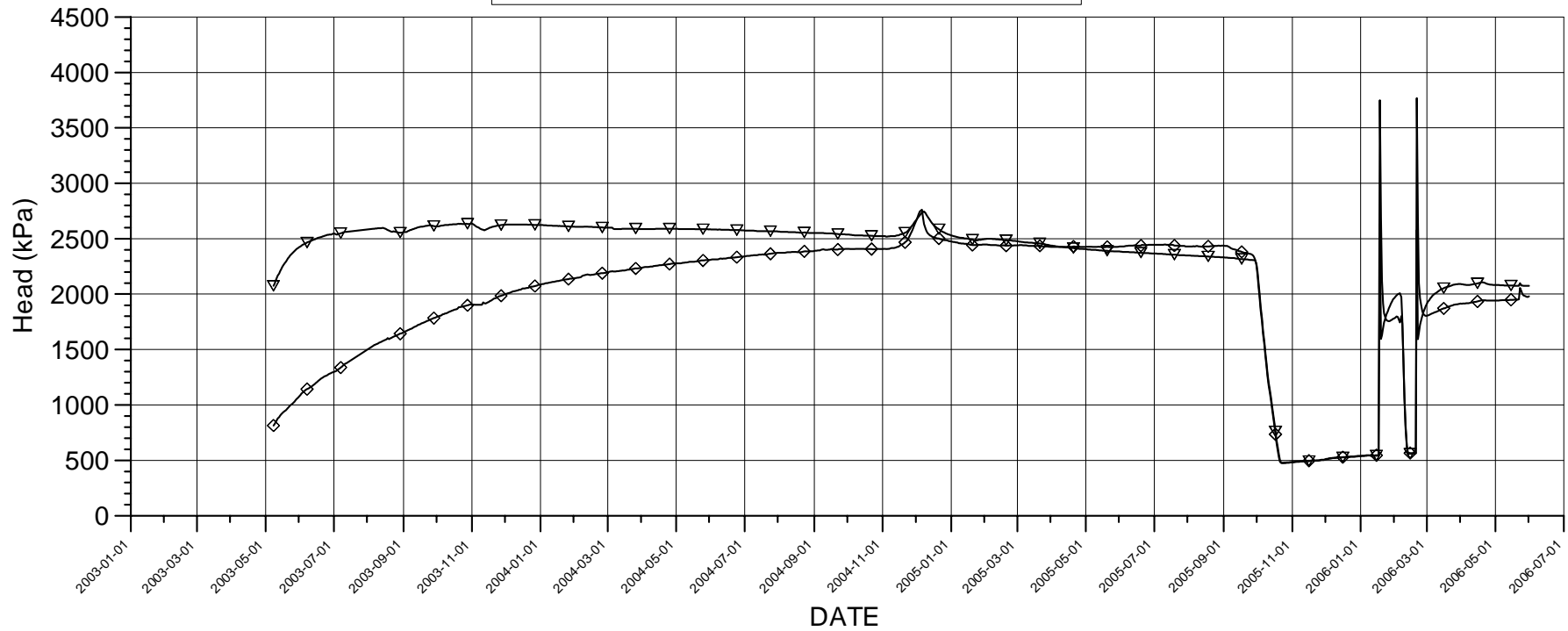
- Start backfilling of section I 2001-09-03
- Stop backfilling of section I 2001-11-20
- Casting of inner plug finalized 2001-12-19
- Start backfilling of section II 2003-04-29
- Stop backfilling of section II 2003-06-27
- Casting of outer plug finalized 2003-09-11

## Borehole sections

- ▽ — ▽ G02:1 22 m - 30.01 m
- ◇ — ◇ G02:2 15.9 m - 21 m
- — □ G02:3 13.2 m - 14.9 m
- — ○ G02:4 10.5 m - 12.2 m
- △ — △ G02:5 1.5 m - 9.5 m

P\_KA3554G02.GRF 2006-06-07

# KA3557G PRESSURE HEAD



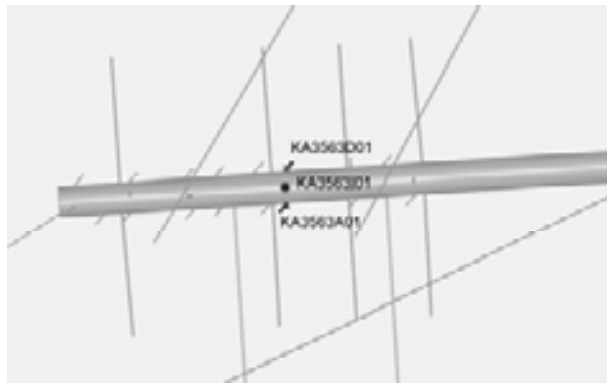
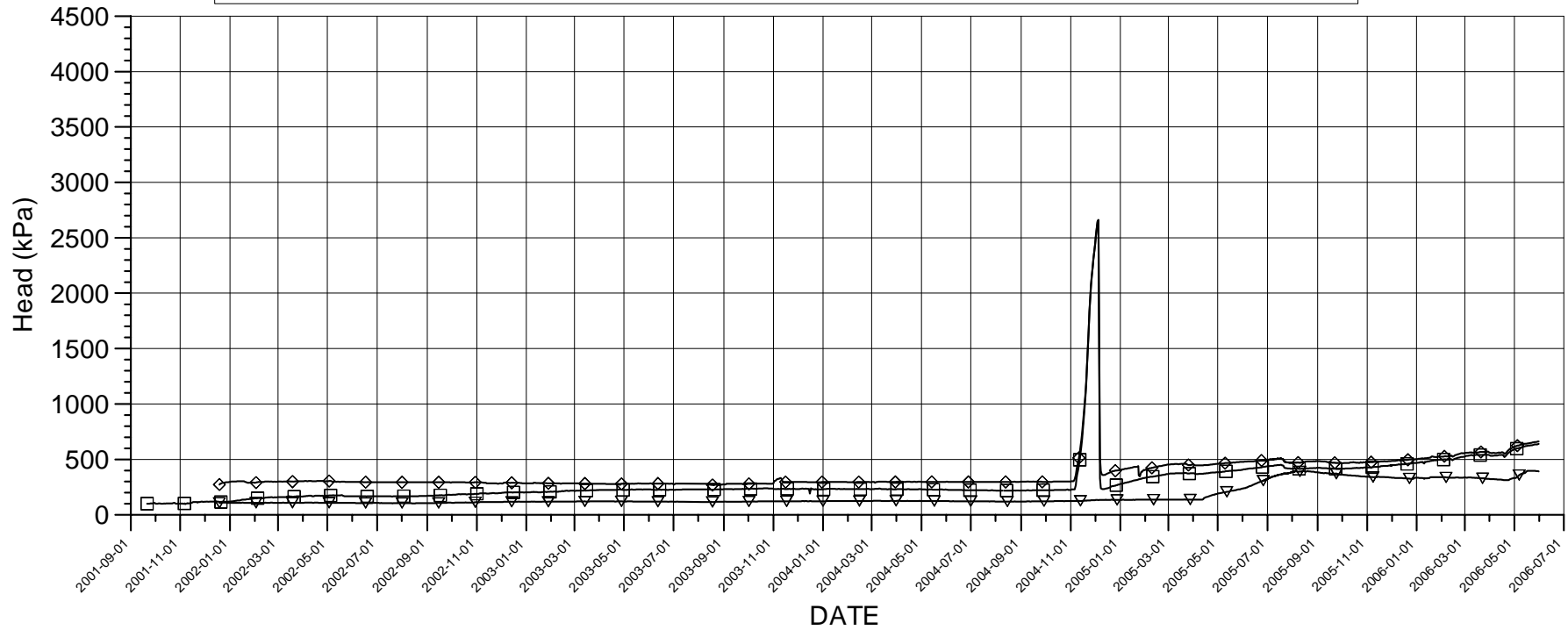
## Events

- Start backfilling of section I 2001-09-03
- Stop backfilling of section I 2001-11-20
- Casting of inner plug finalized 2001-12-19
- Start backfilling of section II 2003-04-29
- Stop backfilling of section II 2003-06-27
- Casting of outer plug finalized 2003-09-11

## Borehole sections

- ▽ — ▽ G:1 15 m - 30.04 m
- ◇ — ◇ G:2 1.5 m - 14 m

# KA3563A01, KA3563D01, KA3563I01 PRESSURE HEAD



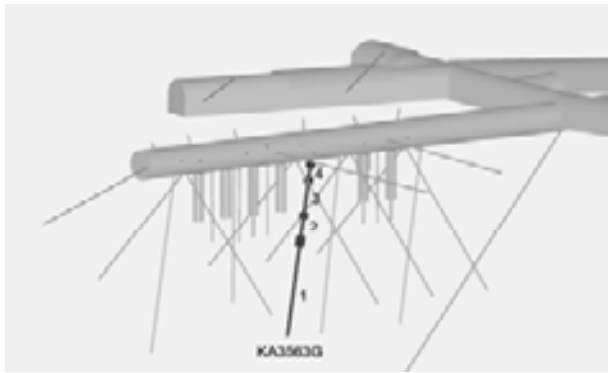
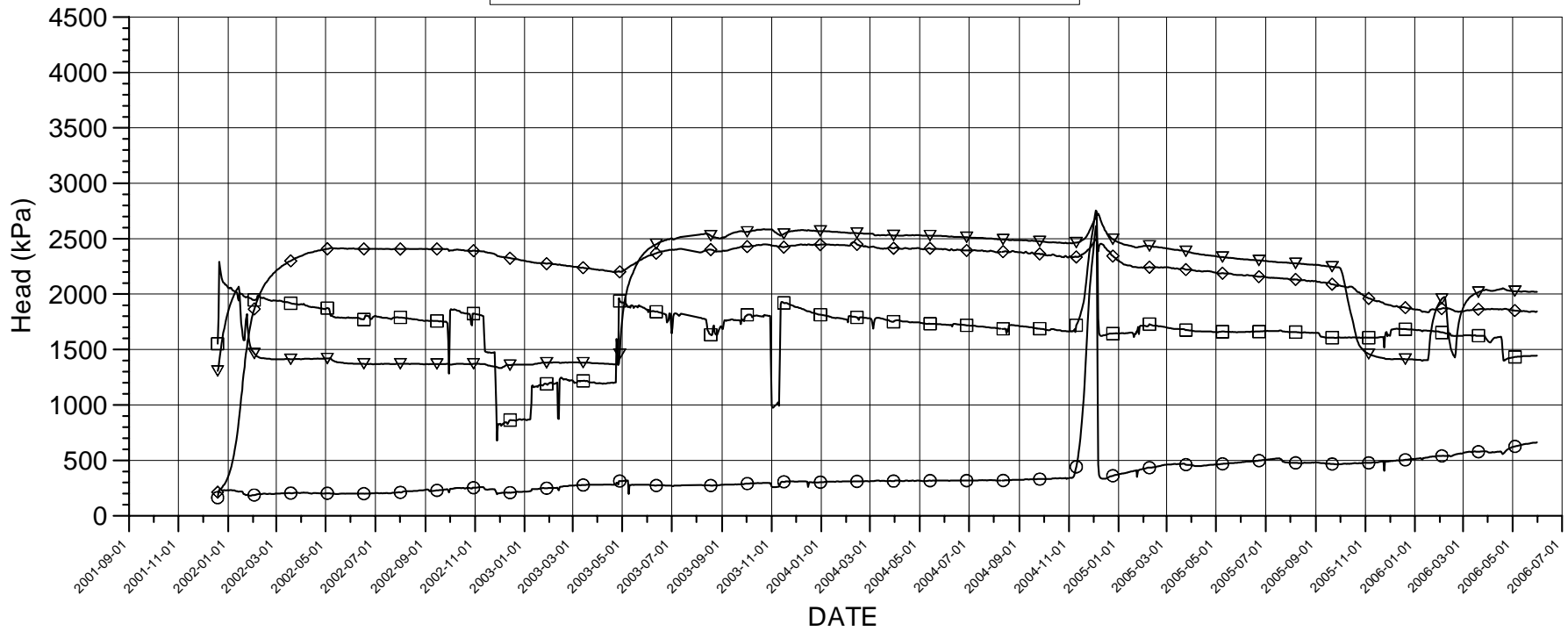
## Events

- Start backfilling of section I 2001-09-03
- Stop backfilling of section I 2001-11-20
- Casting of inner plug finalized 2001-12-19
- Start backfilling of section II 2003-04-29
- Stop backfilling of section II 2003-06-27
- Casting of outer plug finalized 2003-09-11

## Borehole sections

- ▽ KA3563A01:1 0.65 m - 2 m
- ◇ KA3563D01:1 0.65 m - 2 m
- KA3563I01:1 0.65 m - 2 m

# KA3563G PRESSURE HEAD



## Events

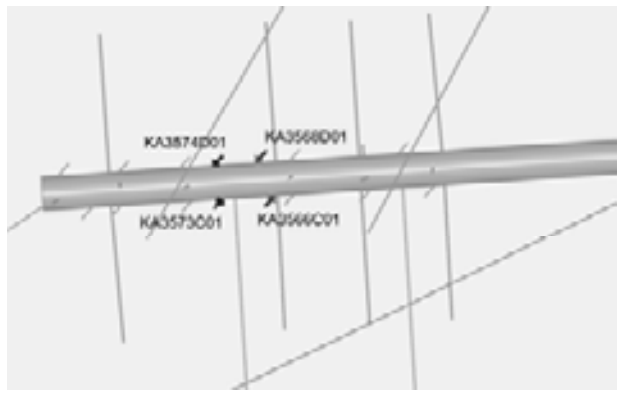
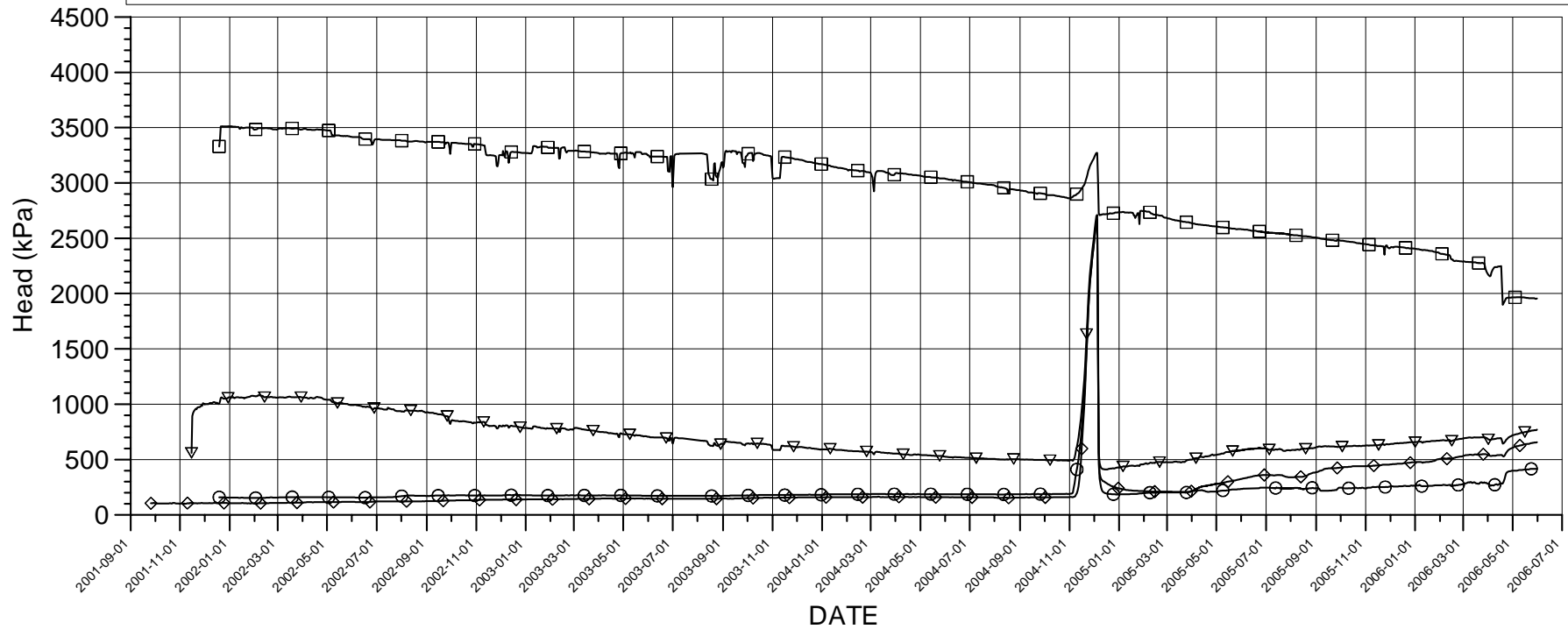
- Start backfilling of section I 2001-09-03
- Stop backfilling of section I 2001-11-20
- Casting of inner plug finalized 2001-12-19
- Start backfilling of section II 2003-04-29
- Stop backfilling of section II 2003-06-27
- Casting of outer plug finalized 2003-09-11

## Borehole sections

- ▽ G:1 15 m - 30 m
- ◇ G:2 10 m - 13 m
- G:3 4 m - 8 m
- G:4 1.5 m - 3 m

P\_KA3563G.GRF 2006-06-07

# KA3566C01, KA3568D01, KA3573C01, KA3574D01 PRESSURE HEAD



## Events

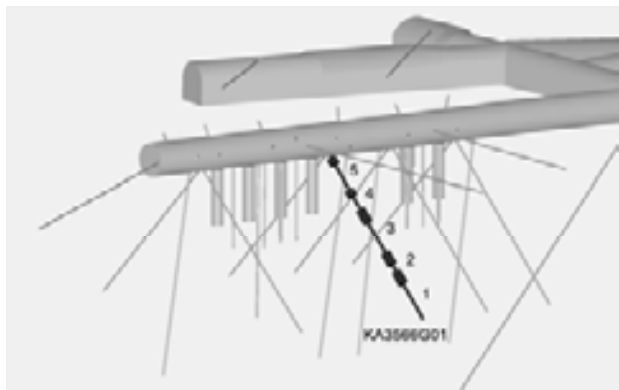
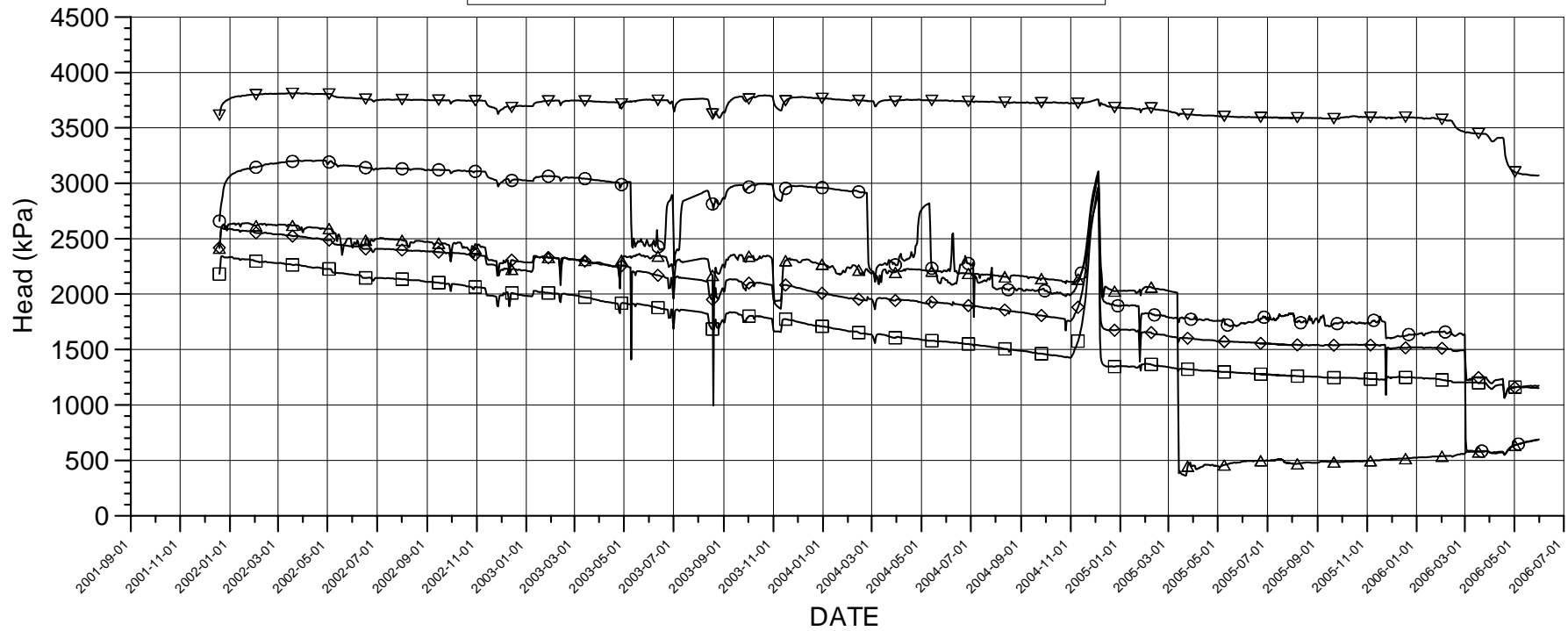
- Start backfilling of section I 2001-09-03
- Stop backfilling of section I 2001-11-20
- Casting of inner plug finalized 2001-12-19
- Start backfilling of section II 2003-04-29
- Stop backfilling of section II 2003-06-27
- Casting of outer plug finalized 2003-09-11

## Borehole sections

- ▽ KA3566C01:1 0.65 m - 2 m
- ◇ KA3568D01:1 0.65 m - 2 m
- KA3573C01:1 0.65 m - 2 m
- ⊙ KA3574D01:1 0.65 m - 2 m

P\_KA3566C01-P\_KA3574D01.GRF 2006-06-07

# KA3566G01 PRESSURE HEAD



## Events

- Start backfilling of section I 2001-09-03
- Stop backfilling of section I 2001-11-20
- Casting of inner plug finalized 2001-12-19
- Start backfilling of section II 2003-04-29
- Stop backfilling of section II 2003-06-27
- Casting of outer plug finalized 2003-09-11

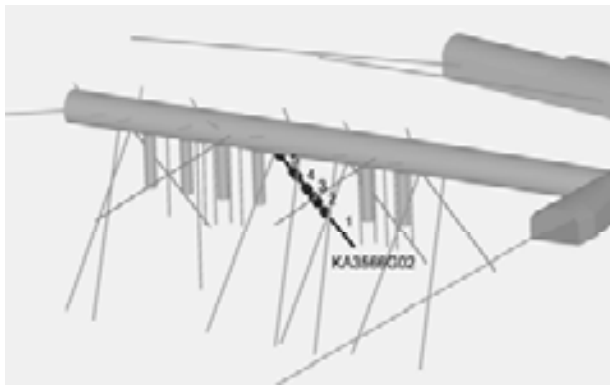
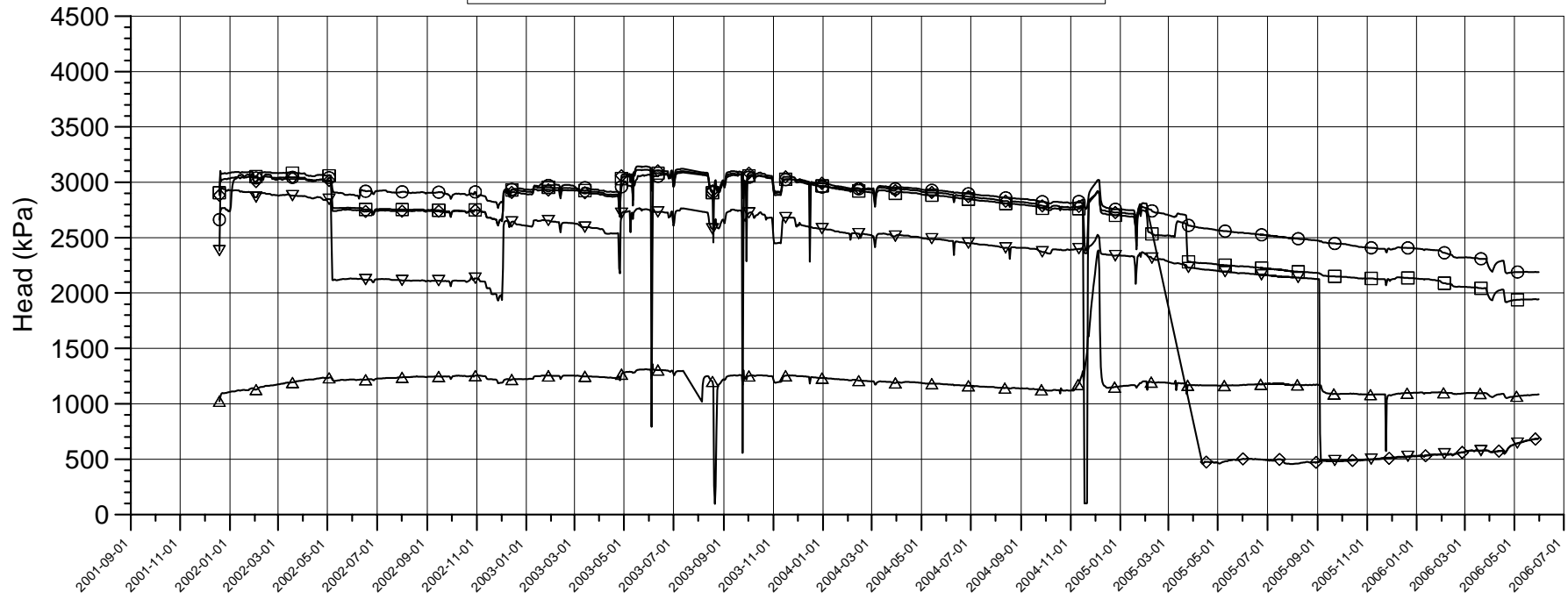
## Borehole sections

- ▽ — ▽ G01:1 23.5 m - 30 m
- ◇ — ◇ G01:2 20 m - 21.5 m
- — □ G01:3 12 m - 18 m
- — ○ G01:4 7.3 m - 10 m
- △ — △ G01:5 1.5 m - 6.3 m

P\_KA3566G01.GRF 2006-06-08



# KA3566G02 PRESSURE HEAD



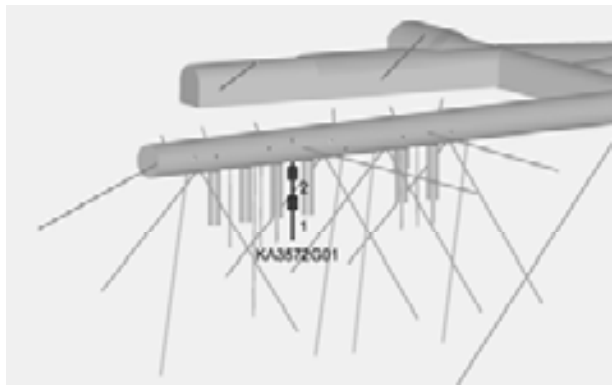
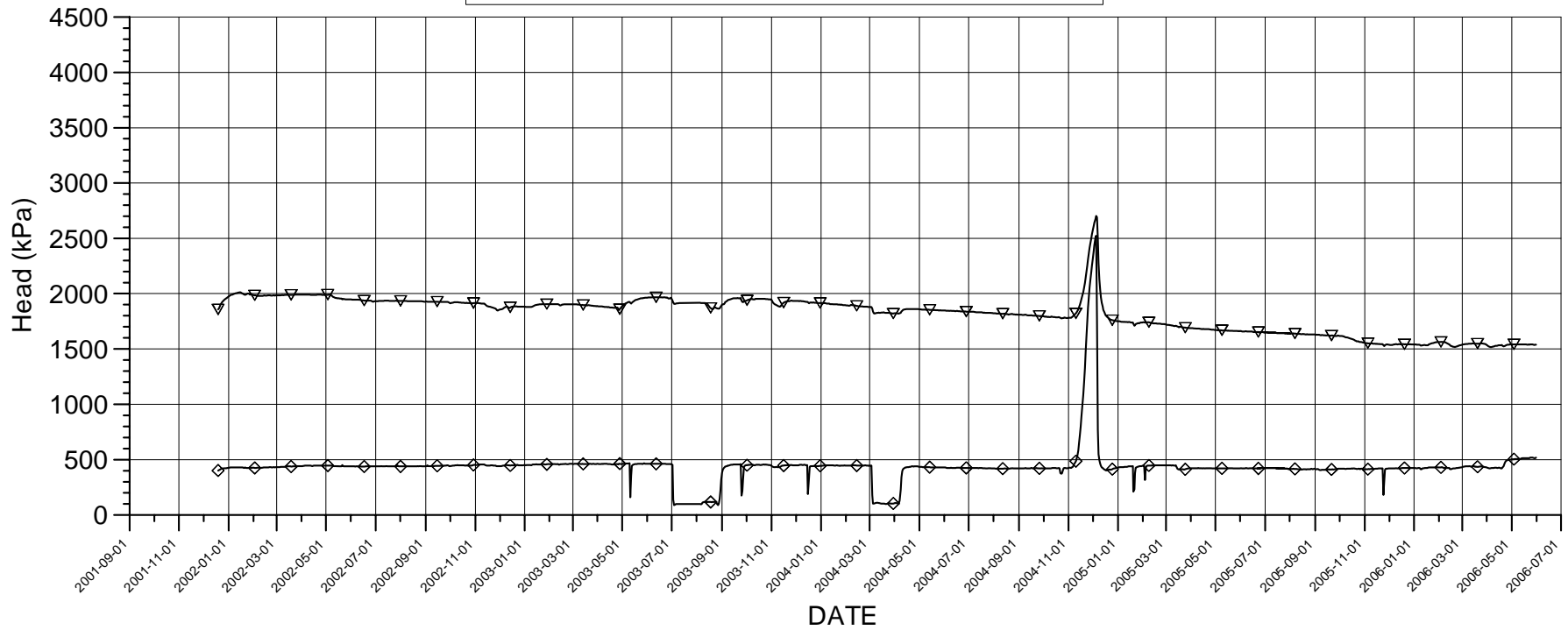
## Events

- Start backfilling of section I 2001-09-03
- Stop backfilling of section I 2001-11-20
- Casting of inner plug finalized 2001-12-19
- Start backfilling of section II 2003-04-29
- Stop backfilling of section II 2003-06-27
- Casting of outer plug finalized 2003-09-11

## Borehole sections

- ▽ — ▽ G02:1 19 m - 30 m
- ◇ — ◇ G02:2 16 m - 18 m
- — □ G02:3 12 m - 14 m
- — ○ G02:4 8 m - 11 m
- △ — △ G02:5 1.5 m - 6 m

# KA3572G01 PRESSURE HEAD



## Events

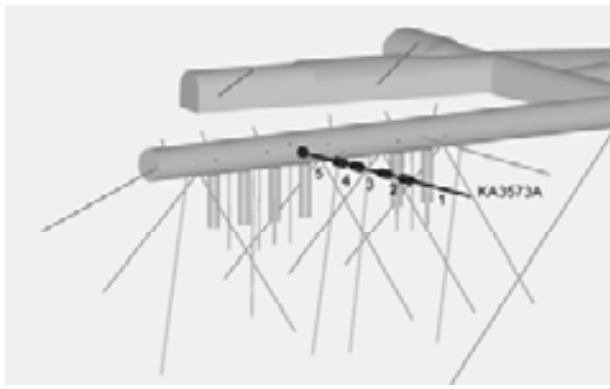
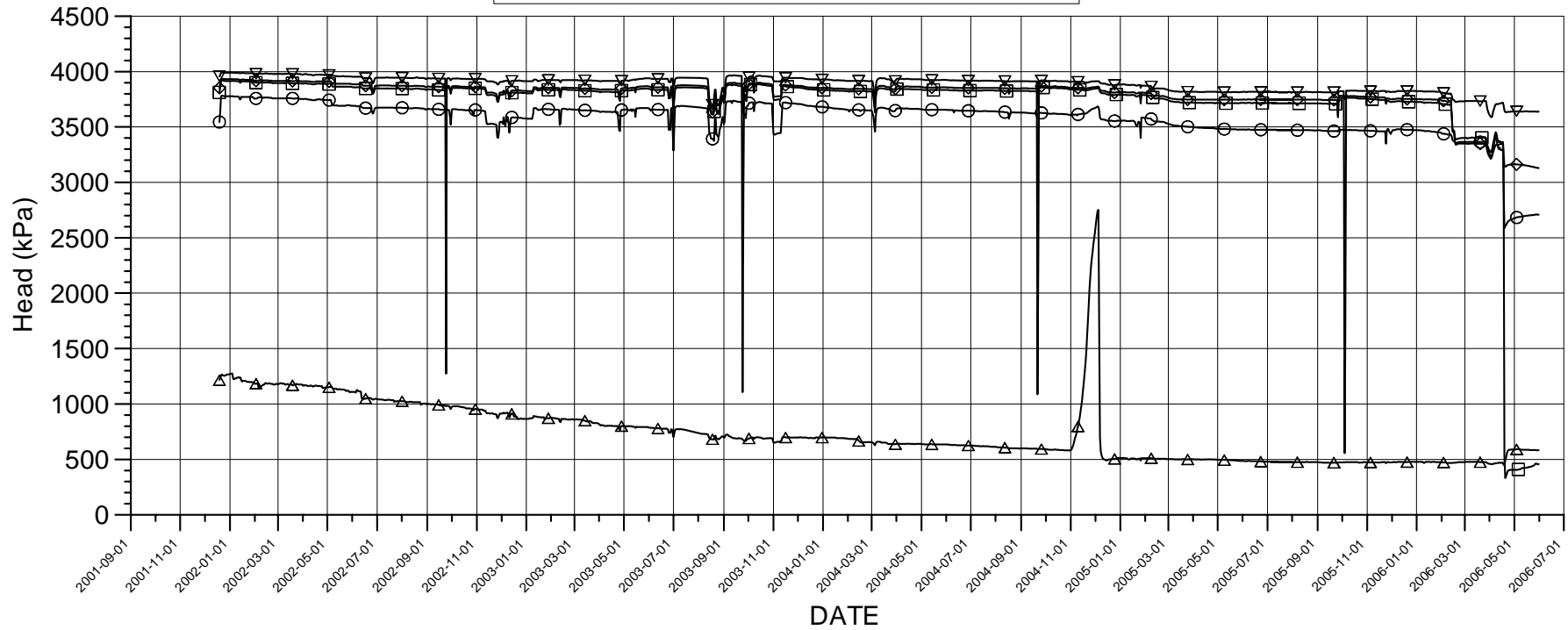
- Start backfilling of section I 2001-09-03
- Stop backfilling of section I 2001-11-20
- Casting of inner plug finalized 2001-12-19
- Start backfilling of section II 2003-04-29
- Stop backfilling of section II 2003-06-27
- Casting of outer plug finalized 2003-09-11

## Borehole sections

- ▽ — ▽ G01:1 7.3 m - 12.0 m
- ◇ — ◇ G01:2 2.7 m - 5.3 m

P\_KA3572G01.GRF 2006-06-08

# KA3573A PRESSURE HEAD



## Events

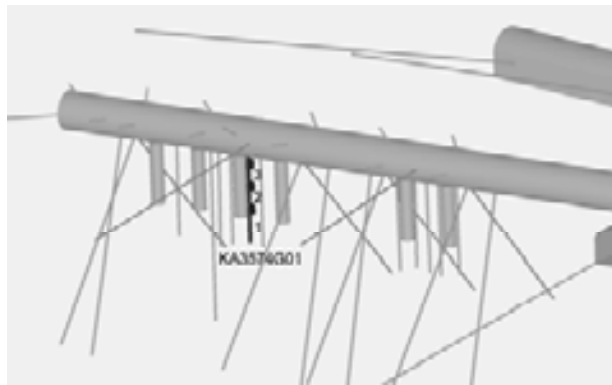
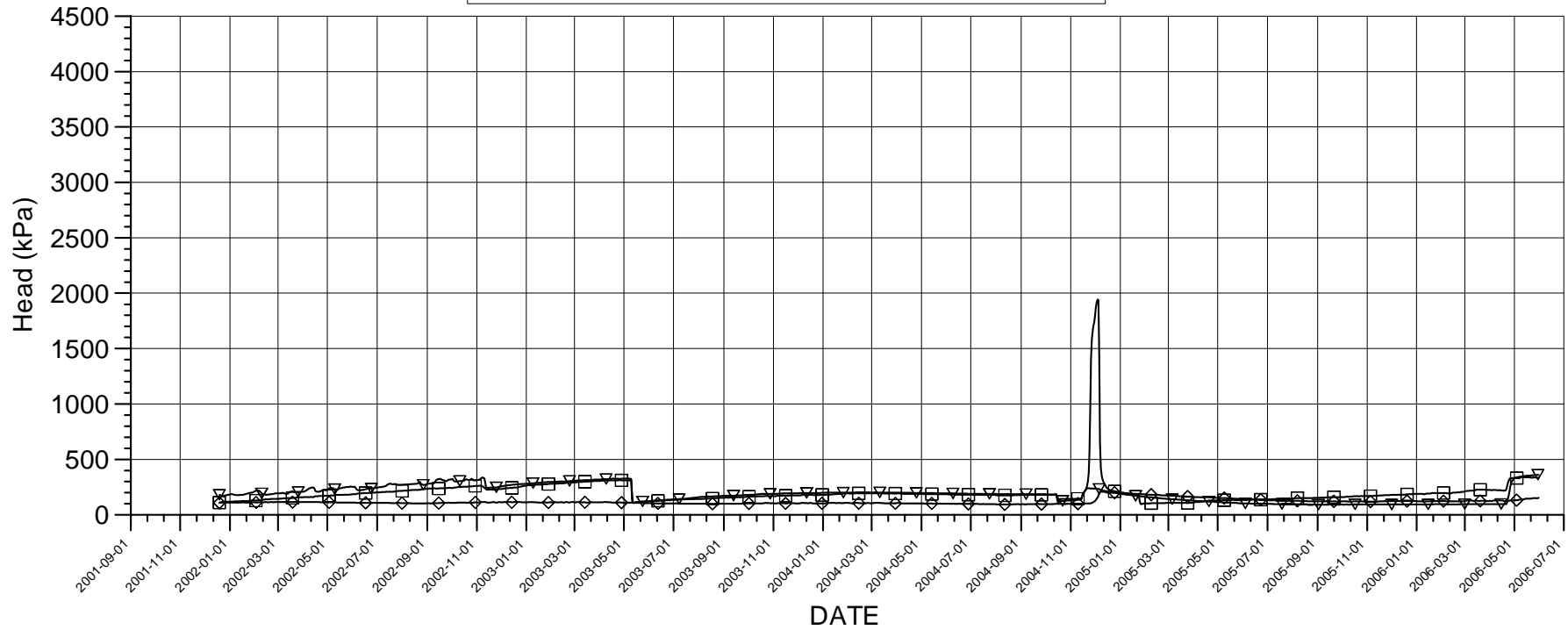
- Start backfilling of section I 2001-09-03
- Stop backfilling of section I 2001-11-20
- Casting of inner plug finalized 2001-12-19
- Start backfilling of section II 2003-04-29
- Stop backfilling of section II 2003-06-27
- Casting of outer plug finalized 2003-09-11

## Borehole sections

- ▽ A:1 26 m - 40.1 m
- ◇ A:2 21 m - 24 m
- A:3 14.5 m - 19 m
- A:4 10.5 m - 12.5 m
- △ A:5 3.4 m - 8.5 m

P\_KA3573A.GRF 2006-06-08

# KA3574G01 PRESSURE HEAD



## Events

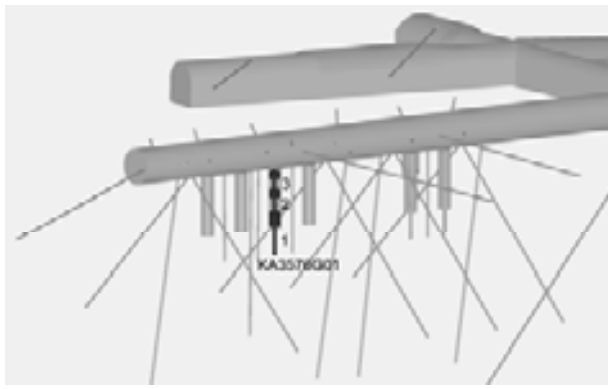
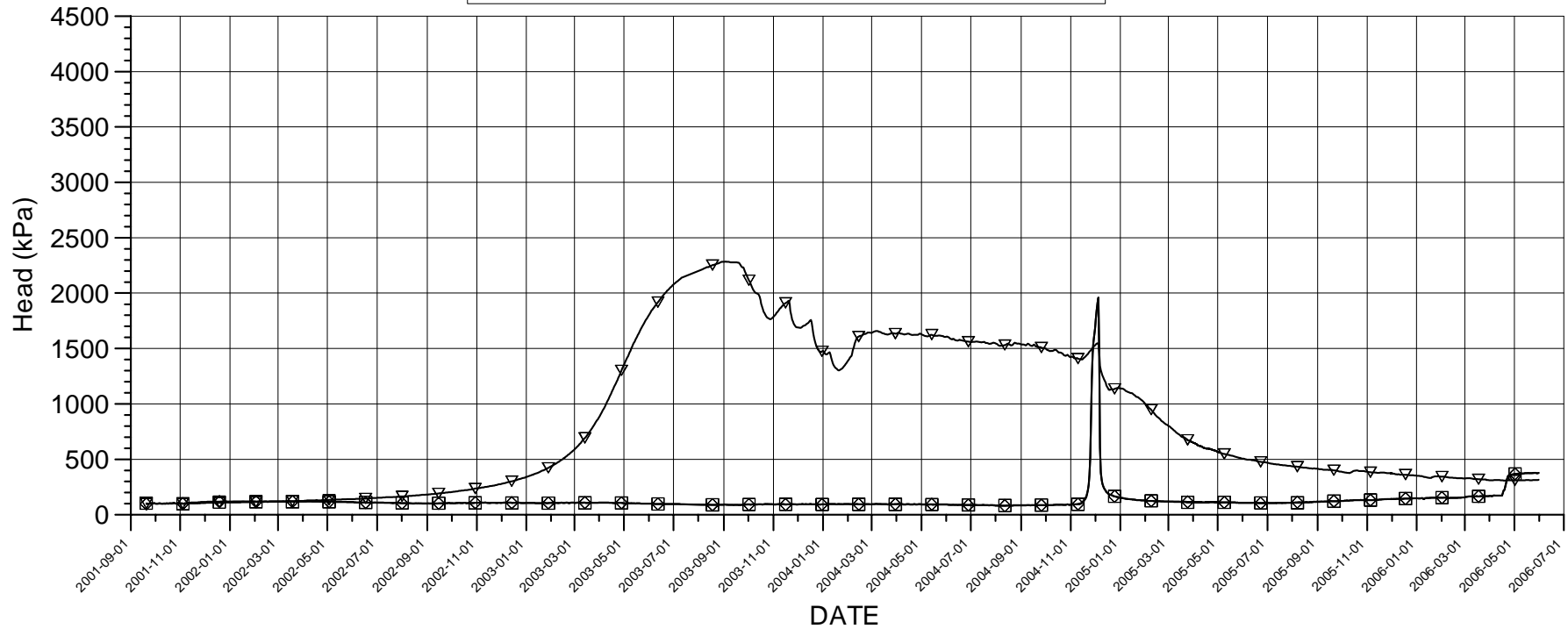
- Start backfilling of section I 2001-09-03
- Stop backfilling of section I 2001-11-20
- Casting of inner plug finalized 2001-12-19
- Start backfilling of section II 2003-04-29
- Stop backfilling of section II 2003-06-27
- Casting of outer plug finalized 2003-09-11

## Borehole sections

- ▽ — ▽ G01:1 8 m - 12 m
- ◇ — ◇ G01:2 5.1 m - 7 m
- — □ G01:3 1.8 m - 4.1 m

P\_KA3574G01.GRF 2006-06-08

# KA3576G01 PRESSURE HEAD



## Events

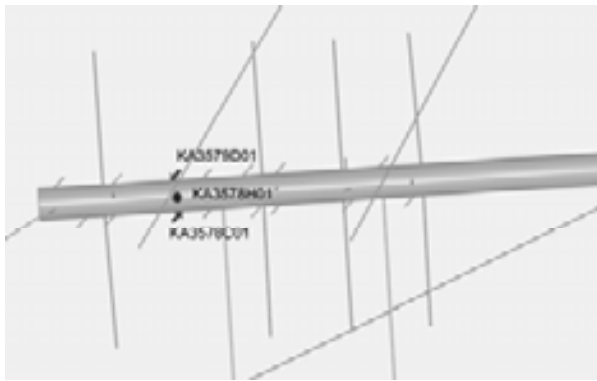
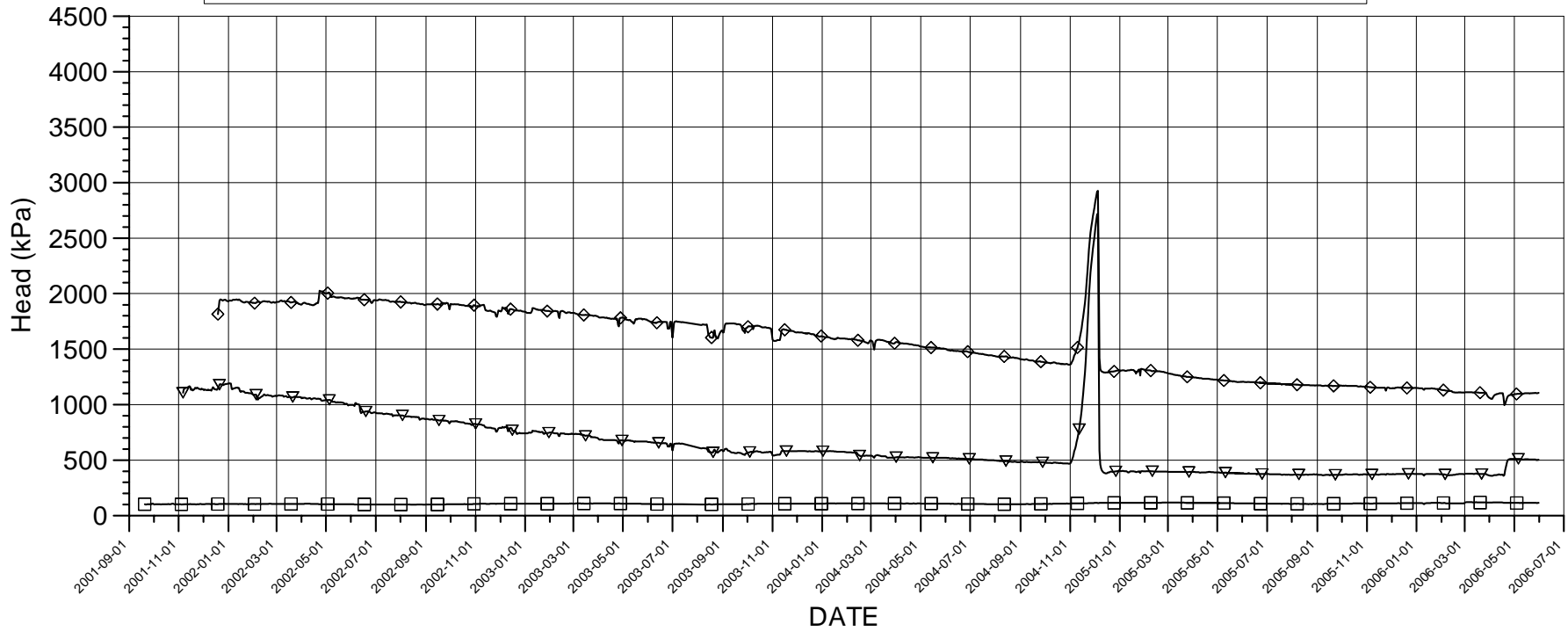
- Start backfilling of section I 2001-09-03
- Stop backfilling of section I 2001-11-20
- Casting of inner plug finalized 2001-12-19
- Start backfilling of section II 2003-04-29
- Stop backfilling of section II 2003-06-27
- Casting of outer plug finalized 2003-09-11

## Borehole sections

- ▽ G01:1 7.9 m - 12 m
- ◇ G01:2 3.9 m - 5.9 m
- G01:3 1.4 m - 2.9 m

P\_KA3576G01.GRF 2006-06-08

# KA3578C01, KA3578H01, KA3579D01 PRESSURE HEAD



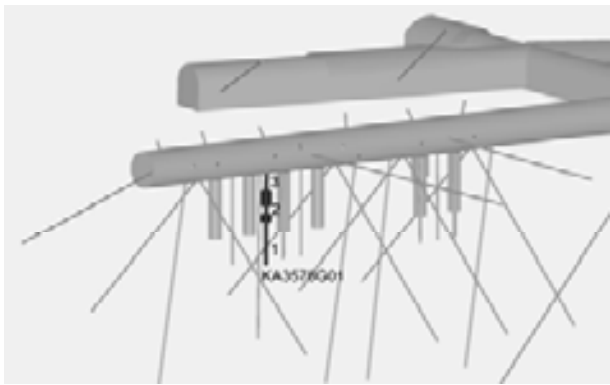
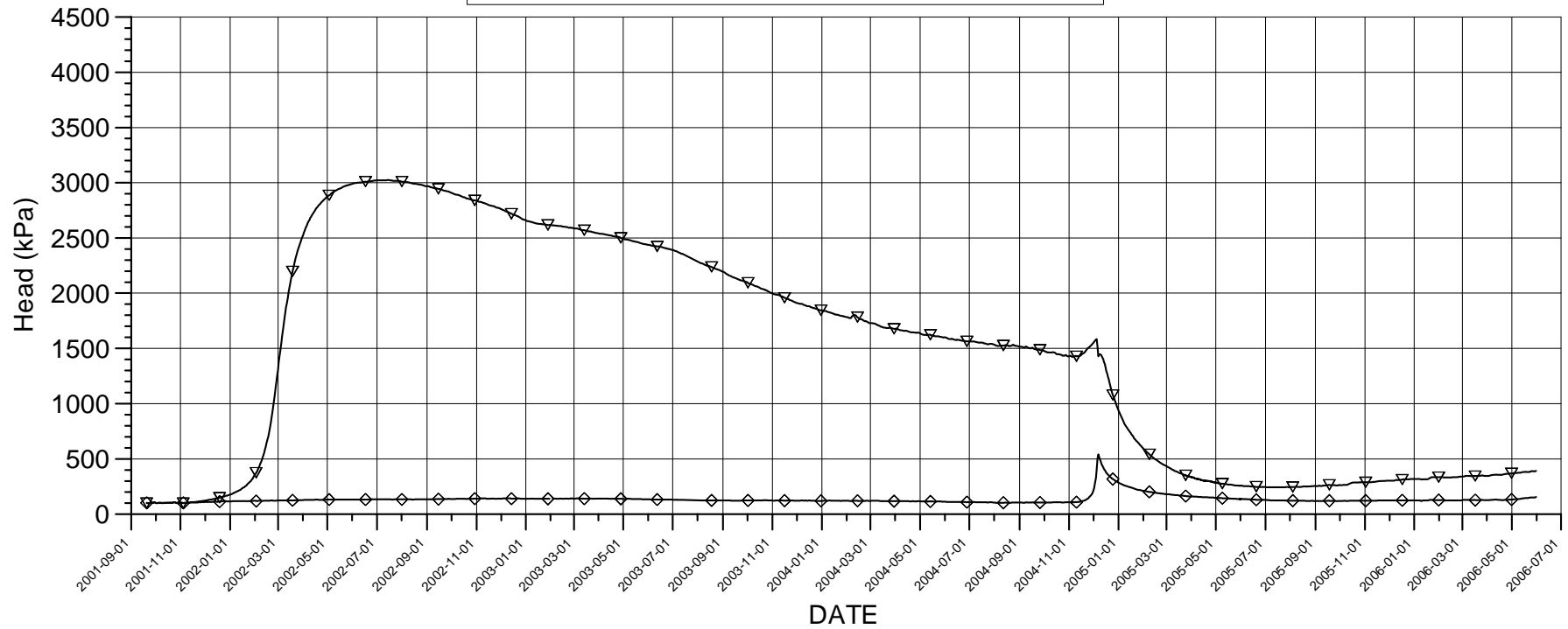
## Events

- Start backfilling of section I 2001-09-03
- Stop backfilling of section I 2001-11-20
- Casting of inner plug finalized 2001-12-19
- Start backfilling of section II 2003-04-29
- Stop backfilling of section II 2003-06-27
- Casting of outer plug finalized 2003-09-11

## Borehole sections

- ▽ KA3578C01:1 0.65 m - 2 m
- ◇ KA3578H01:1 0.65 m - 2 m
- KA3579D01:1 0.65 m - 2 m

# KA3578G01 PRESSURE HEAD



## Events

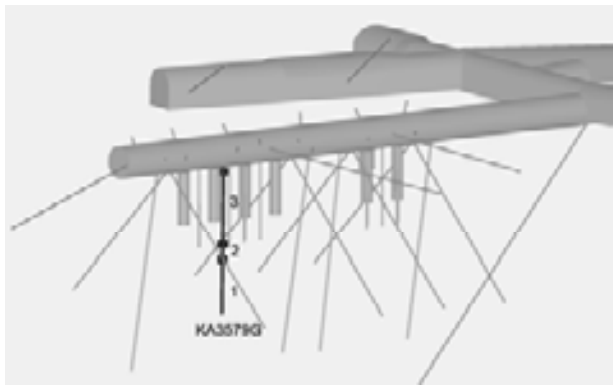
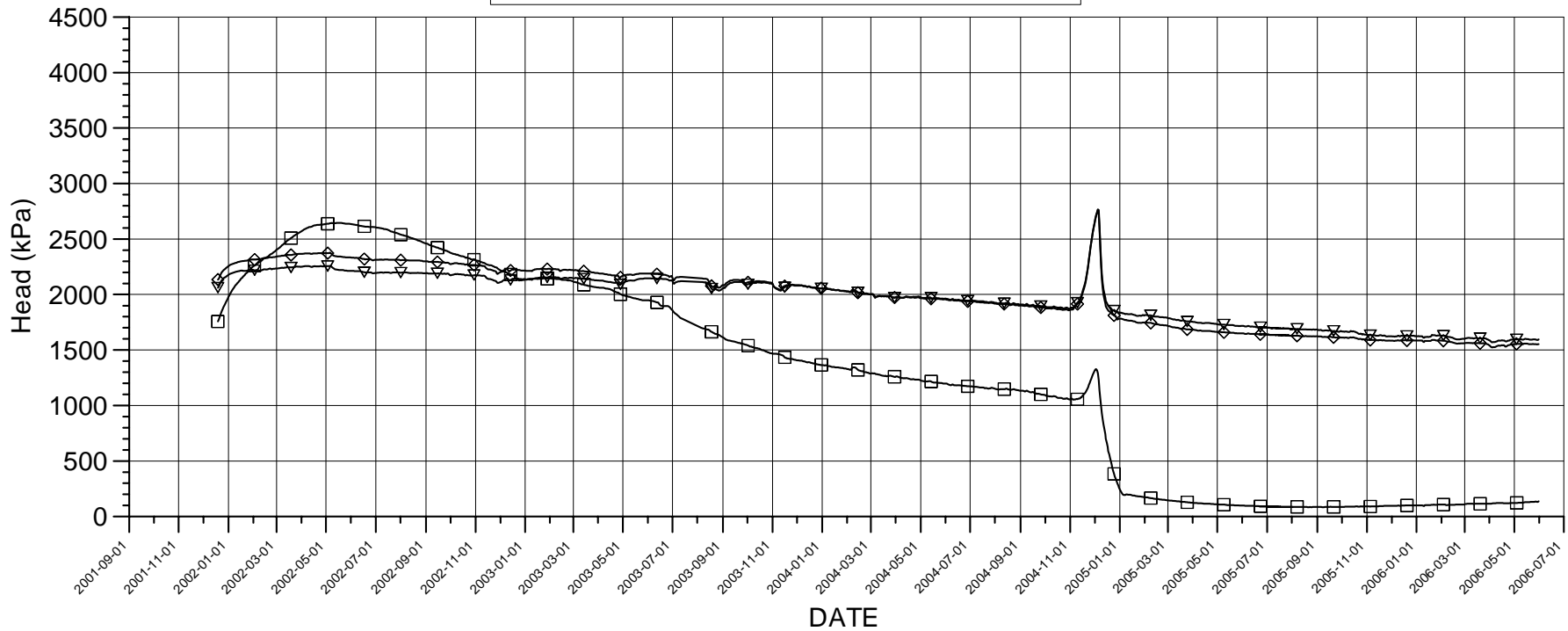
- Start backfilling of section I 2001-09-03
- Stop backfilling of section I 2001-11-20
- Casting of inner plug finalized 2001-12-19
- Start backfilling of section II 2003-04-29
- Stop backfilling of section II 2003-06-27
- Casting of outer plug finalized 2003-09-11

## Borehole sections

- ▽ G01:1 6.5 m - 12.6 m
- ◇ G01:2 4.3 m - 5.5 m

P\_KA3578G01.GRF 2006-06-08

# KA3579G PRESSURE HEAD



## Events

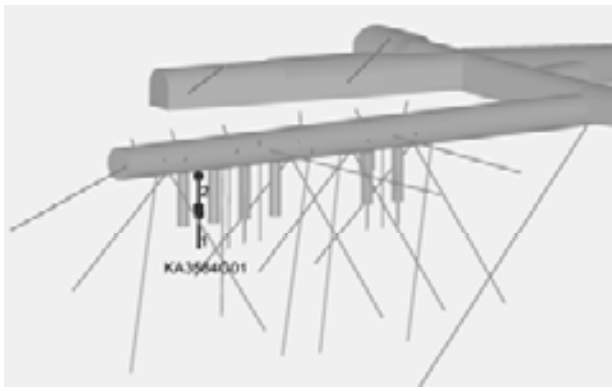
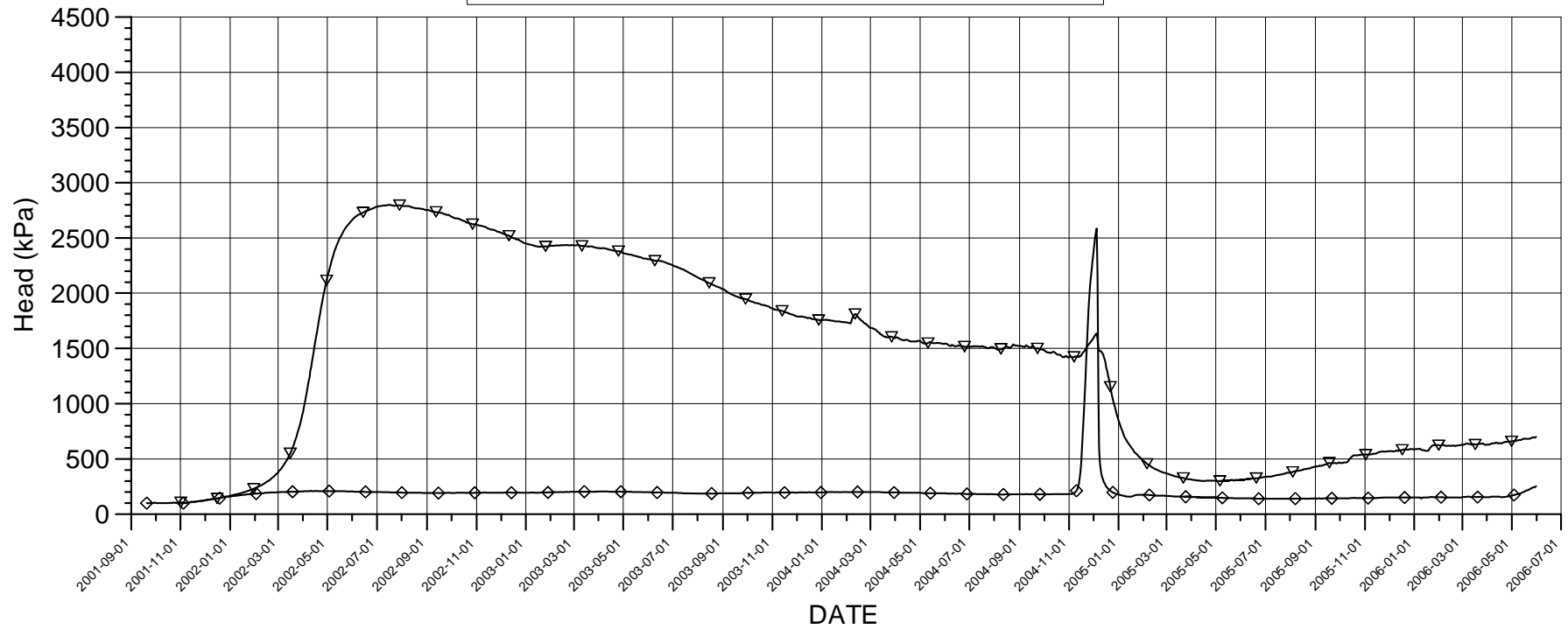
- Start backfilling of section I 2001-09-03
- Stop backfilling of section I 2001-11-20
- Casting of inner plug finalized 2001-12-19
- Start backfilling of section II 2003-04-29
- Stop backfilling of section II 2003-06-27
- Casting of outer plug finalized 2003-09-11

## Borehole sections

- ▽ G:1 14.7 m - 22.7 m
- ◇ G:2 12.5 m - 13.7 m
- G:3 2.5 m - 11.5 m



# KA3584G01 PRESSURE HEAD



## Events

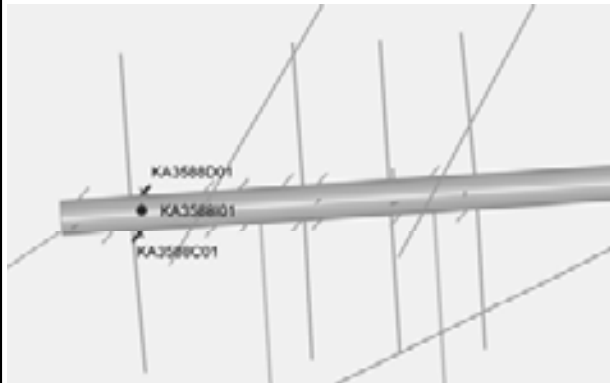
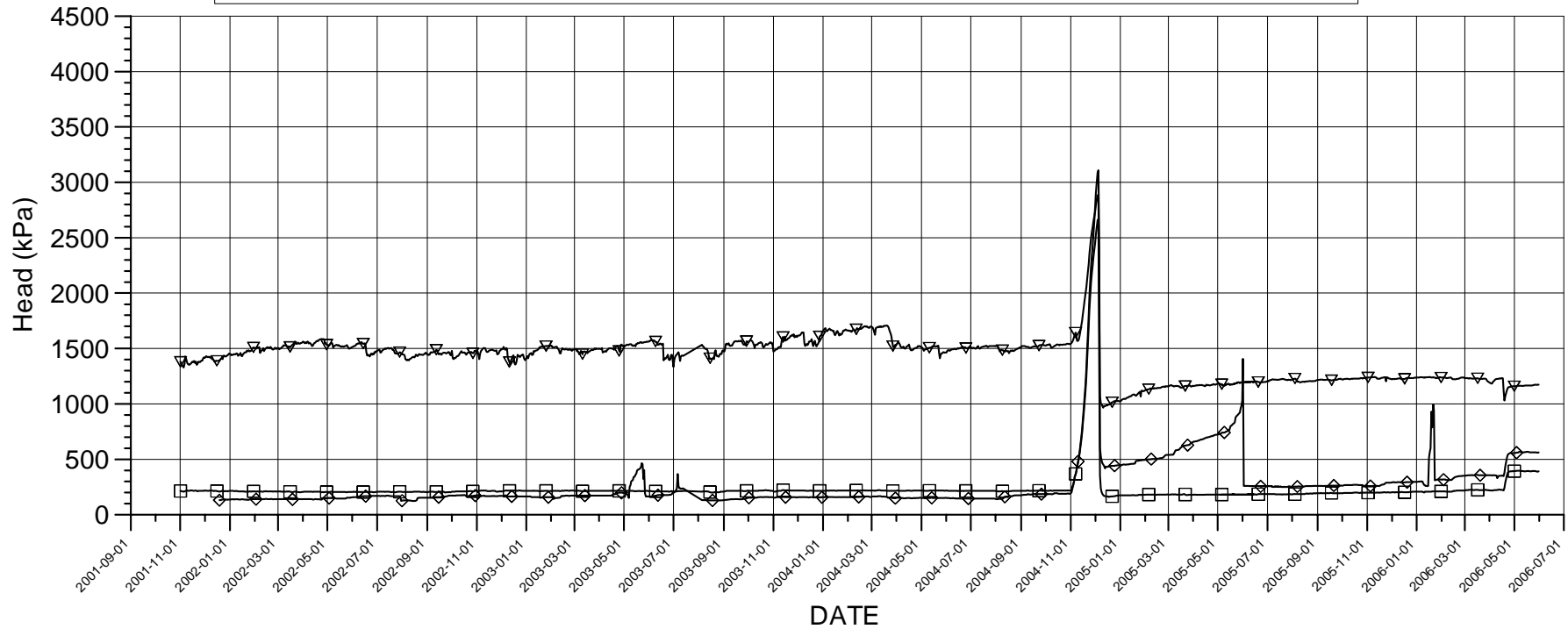
- Start backfilling of section I 2001-09-03
- Stop backfilling of section I 2001-11-20
- Casting of inner plug finalized 2001-12-19
- Start backfilling of section II 2003-04-29
- Stop backfilling of section II 2003-06-27
- Casting of outer plug finalized 2003-09-11

## Borehole sections

- ▽ — ▽ G01:1 7 m - 12 m
- ◇ — ◇ G01:2 1.4 m - 5 m

P\_KA3584G01.GRF 2006-06-08

# KA3588C01, KA3588D01, KA3588I01 PRESSURE HEAD



## Events

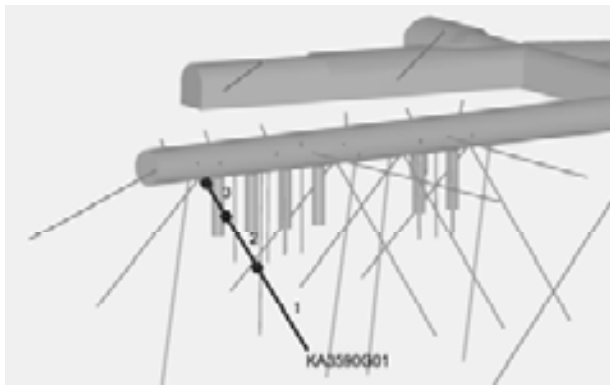
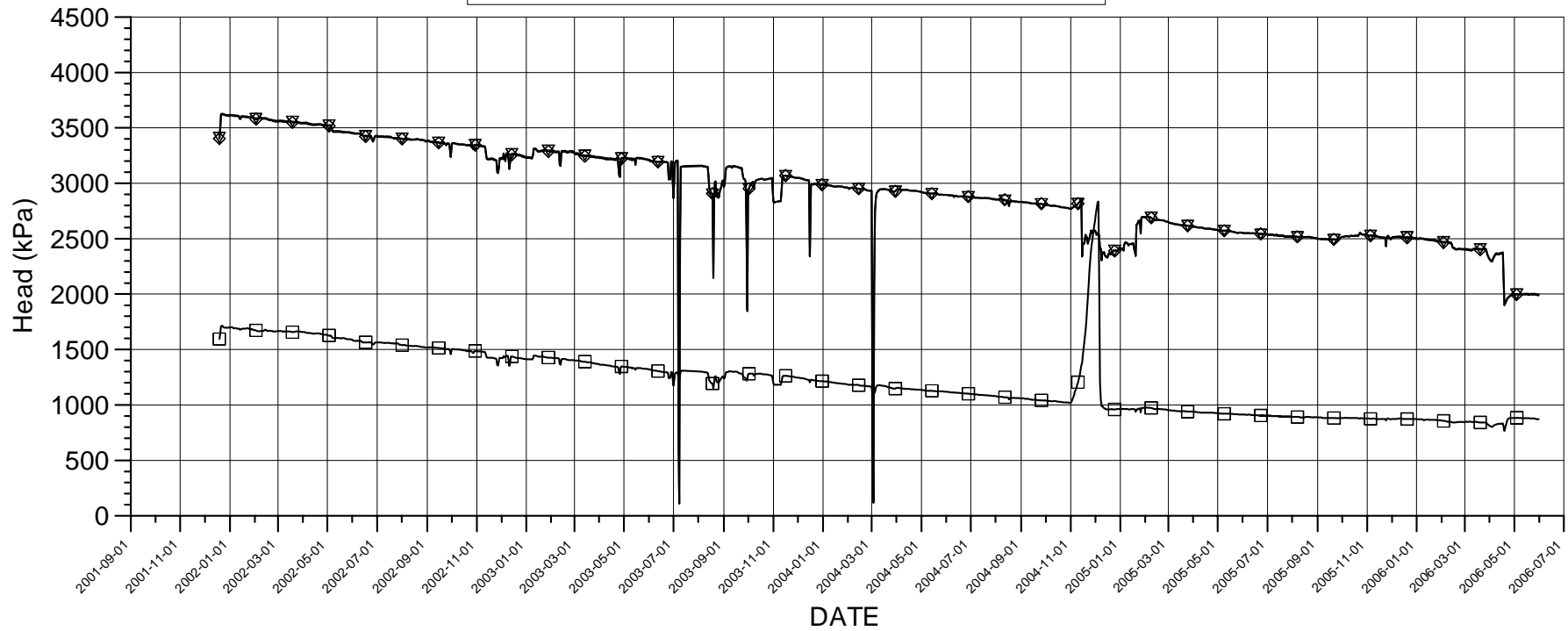
- Start backfilling of section I 2001-09-03
- Stop backfilling of section I 2001-11-20
- Casting of inner plug finalized 2001-12-19
- Start backfilling of section II 2003-04-29
- Stop backfilling of section II 2003-06-27
- Casting of outer plug finalized 2003-09-11

## Borehole sections

- ▽ KA3588C01:1 0.65 m - 2 m
- ◇ KA3588D01:1 0.65 m - 2 m
- KA3588I01:1 0.65 m - 2 m

P\_KA3588C01-P\_KA3588I01.GRF 2006-06-08

# KA3590G01 PRESSURE HEAD



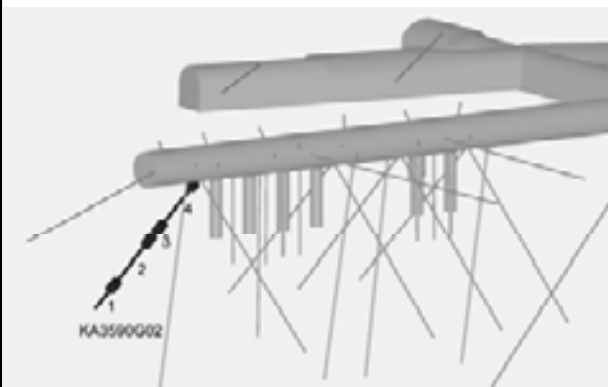
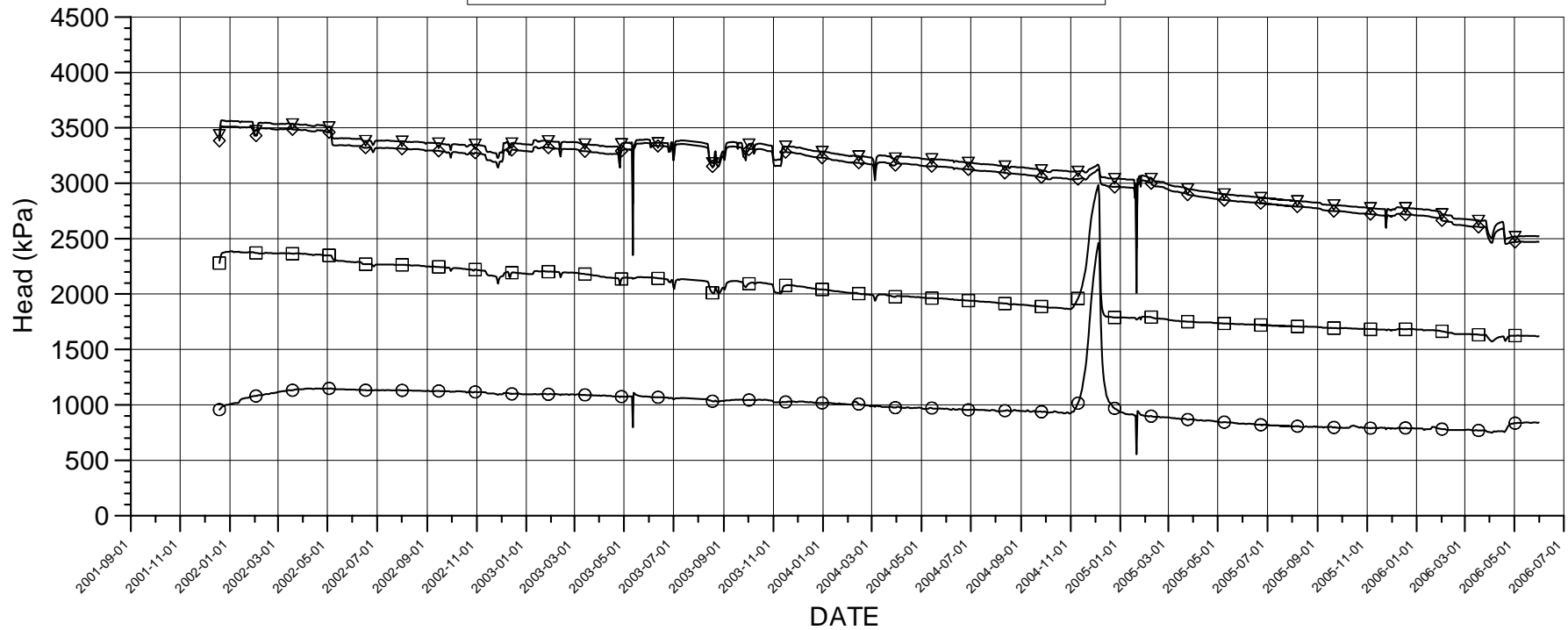
## Events

- Start backfilling of section I 2001-09-03
- Stop backfilling of section I 2001-11-20
- Casting of inner plug finalized 2001-12-19
- Start backfilling of section II 2003-04-29
- Stop backfilling of section II 2003-06-27
- Casting of outer plug finalized 2003-09-11

## Borehole sections

- ▽ G01:1 16 m - 30 m
- ◇ G01:2 7 m - 15 m
- G01:3 1.5 m - 6 m

# KA3590G02 PRESSURE HEAD



## Events

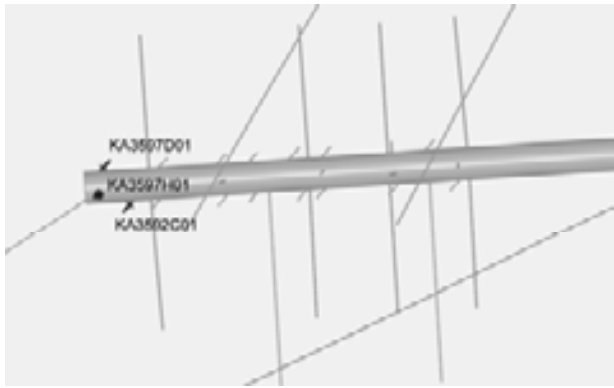
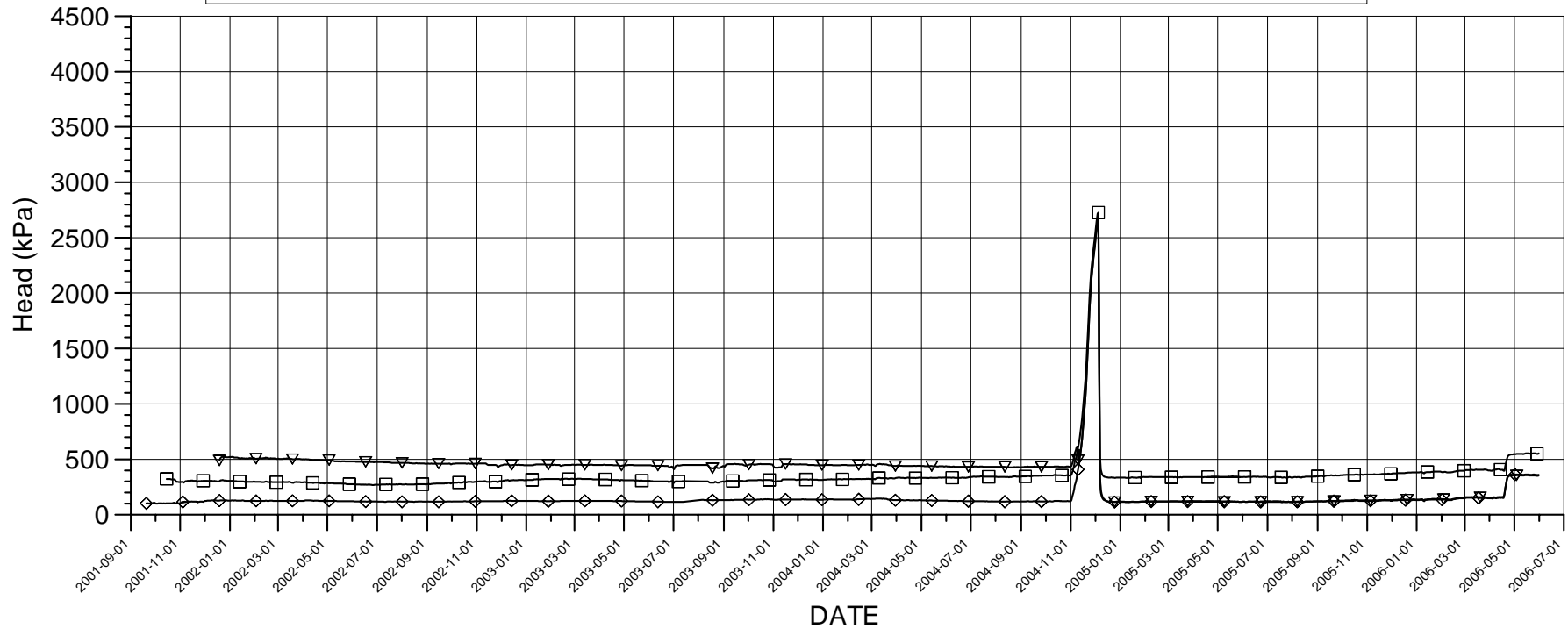
- Start backfilling of section I 2001-09-03
- Stop backfilling of section I 2001-11-20
- Casting of inner plug finalized 2001-12-19
- Start backfilling of section II 2003-04-29
- Stop backfilling of section II 2003-06-27
- Casting of outer plug finalized 2003-09-11

## Borehole sections

- ▽ — ▽ G02:1 25.65 m - 30 m
- ◇ — ◇ G02:2 15.35 m - 23.65 m
- — □ G02:3 12.05 m - 13.35 m
- — ○ G02:4 1.65 m - 10.05 m

P\_KA3590G02.GRF 2006-06-08

# KA3592C01, KA3597D01, KA3597H01 PRESSURE HEAD



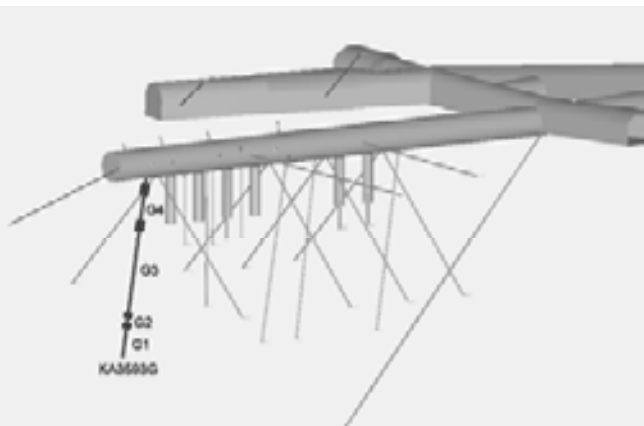
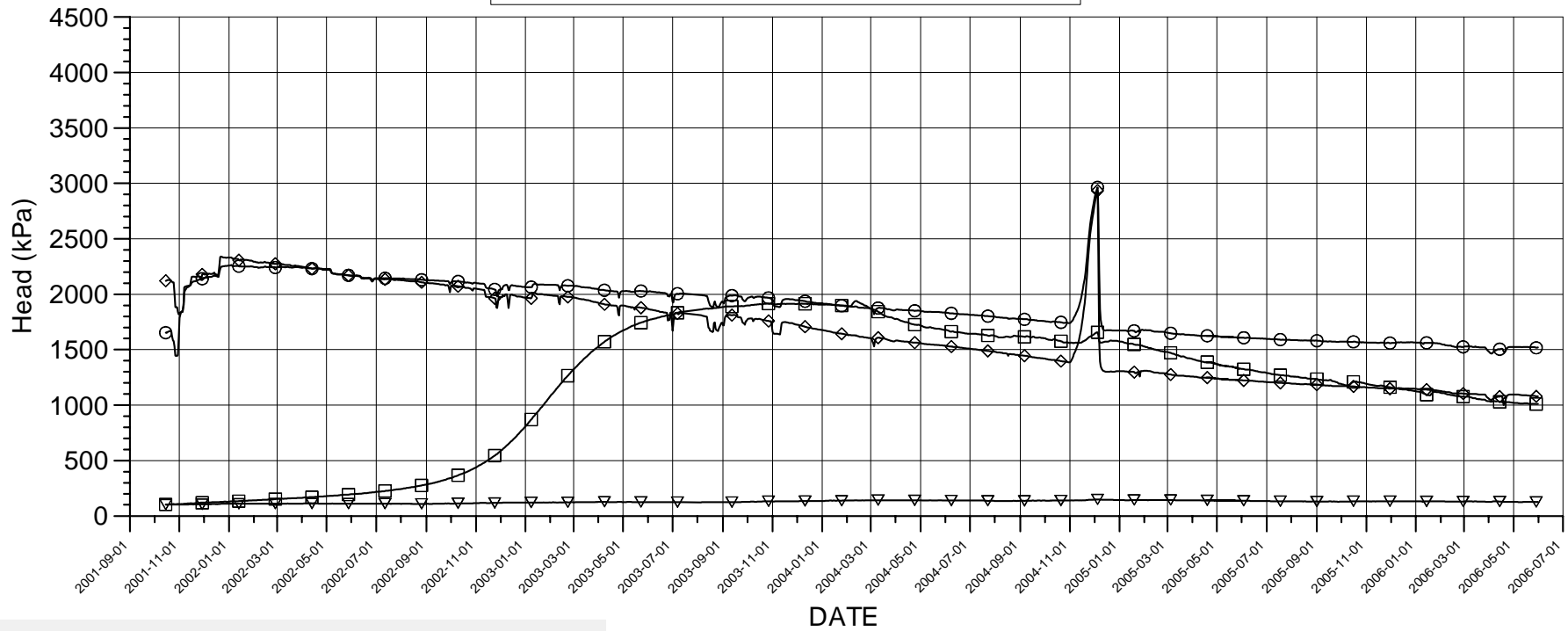
**Events**

- Start backfilling of section I 2001-09-03
- Stop backfilling of section I 2001-11-20
- Casting of inner plug finalized 2001-12-19
- Start backfilling of section II 2003-04-29
- Stop backfilling of section II 2003-06-27
- Casting of outer plug finalized 2003-09-11

**Borehole sections**

- ▽ KA3592C01:1 0.65 m - 2 m
- ◇ KA3597D01:1 0.65 m - 2 m
- KA3597H01:1 0.65 m - 2 m

# KA3593G PRESSURE HEAD



## Events

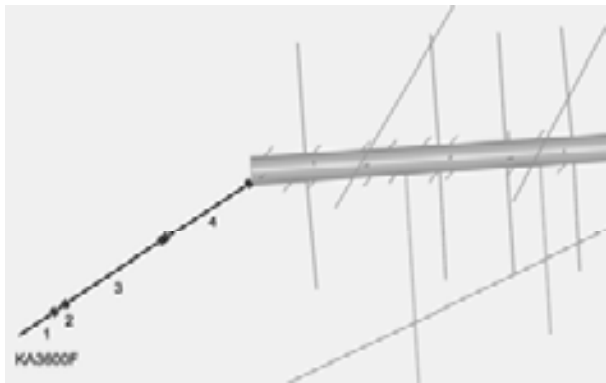
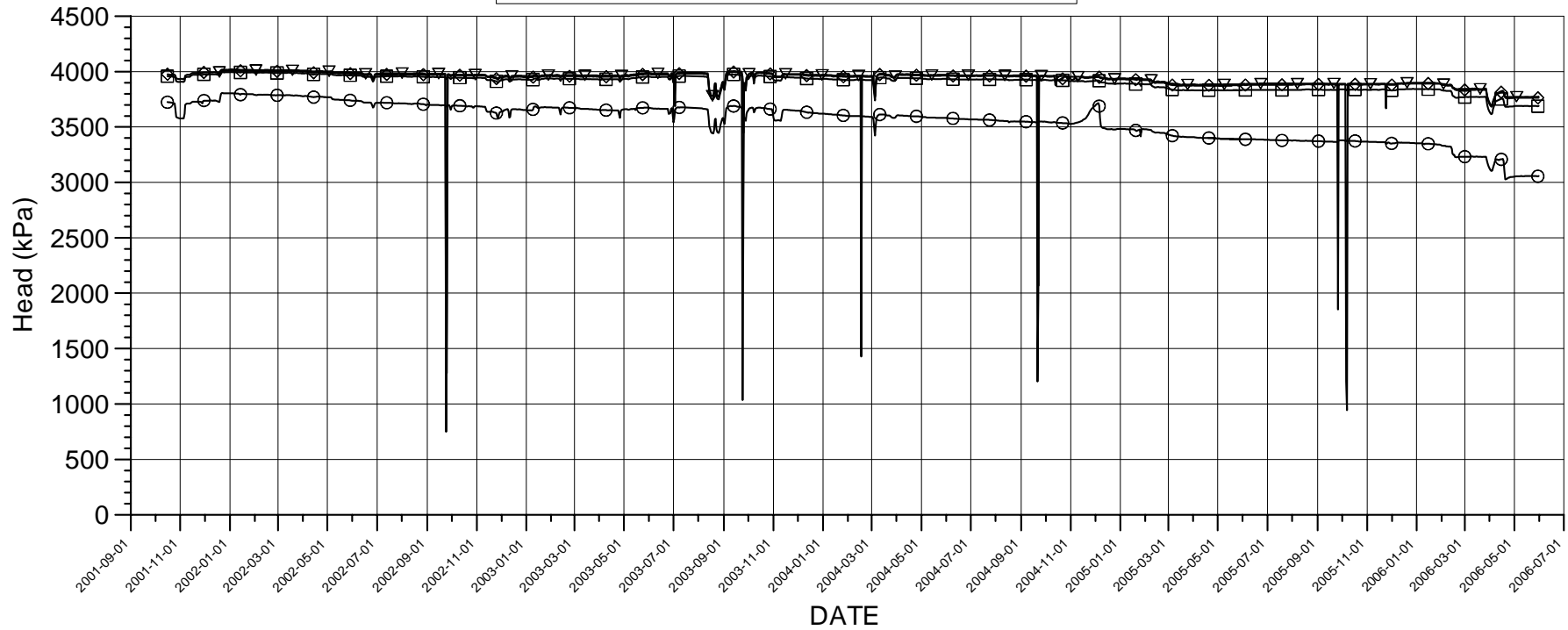
- Start backfilling of section I 2001-09-03
- Stop backfilling of section I 2001-11-20
- Casting of inner plug finalized 2001-12-19
- Start backfilling of section II 2003-04-29
- Stop backfilling of section II 2003-06-27
- Casting of outer plug finalized 2003-09-11

## Borehole sections

- ▽ — ▽ G:1 25.2 m - 30 m
- ◇ — ◇ G:2 23.5 m - 24.2 m
- — □ G:3 9 m - 22.5 m
- — ○ G:4 3 m - 7 m

P\_KA3593G.GRF 2006-06-08

# KA3600F PRESSURE HEAD



## Events

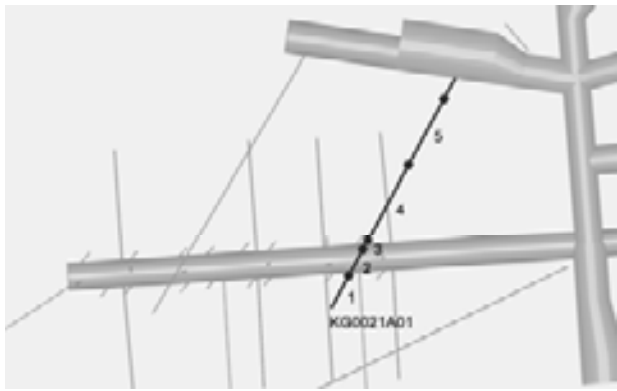
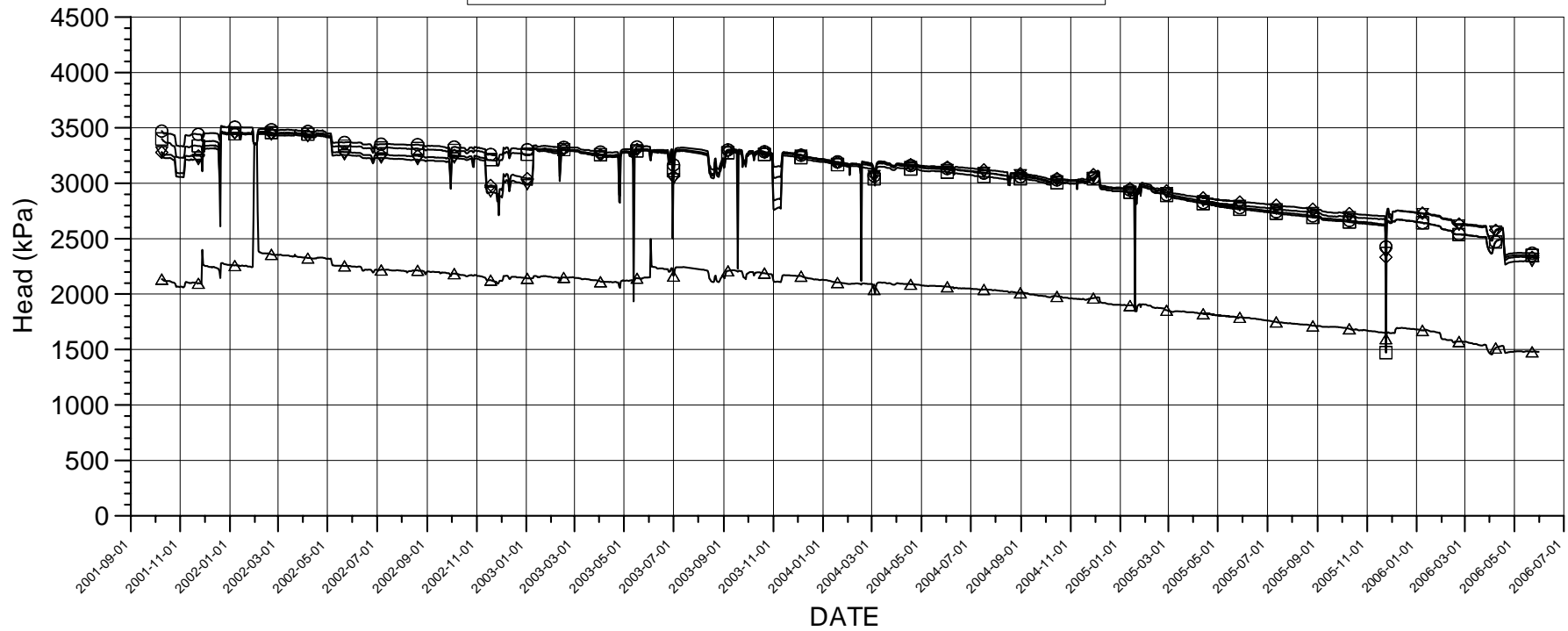
- Start backfilling of section I 2001-09-03
- Stop backfilling of section I 2001-11-20
- Casting of inner plug finalized 2001-12-19
- Start backfilling of section II 2003-04-29
- Stop backfilling of section II 2003-06-27
- Casting of outer plug finalized 2003-09-11

## Borehole sections

- ▽ F:1 43 m - 50.1 m
- ◇ F:2 40.5 m - 42 m
- F:3 20 m - 39.5 m
- F:4 3.4 m - 18 m

P\_KA3600F.GRF 2006-06-08

# KG0021A01 PRESSURE HEAD



## Events

- Start backfilling of section I 2001-09-03
- Stop backfilling of section I 2001-11-20
- Casting of inner plug finalized 2001-12-19
- Start backfilling of section II 2003-04-29
- Stop backfilling of section II 2003-06-27
- Casting of outer plug finalized 2003-09-11

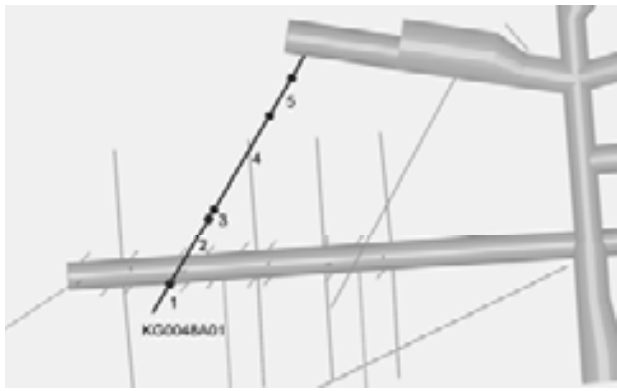
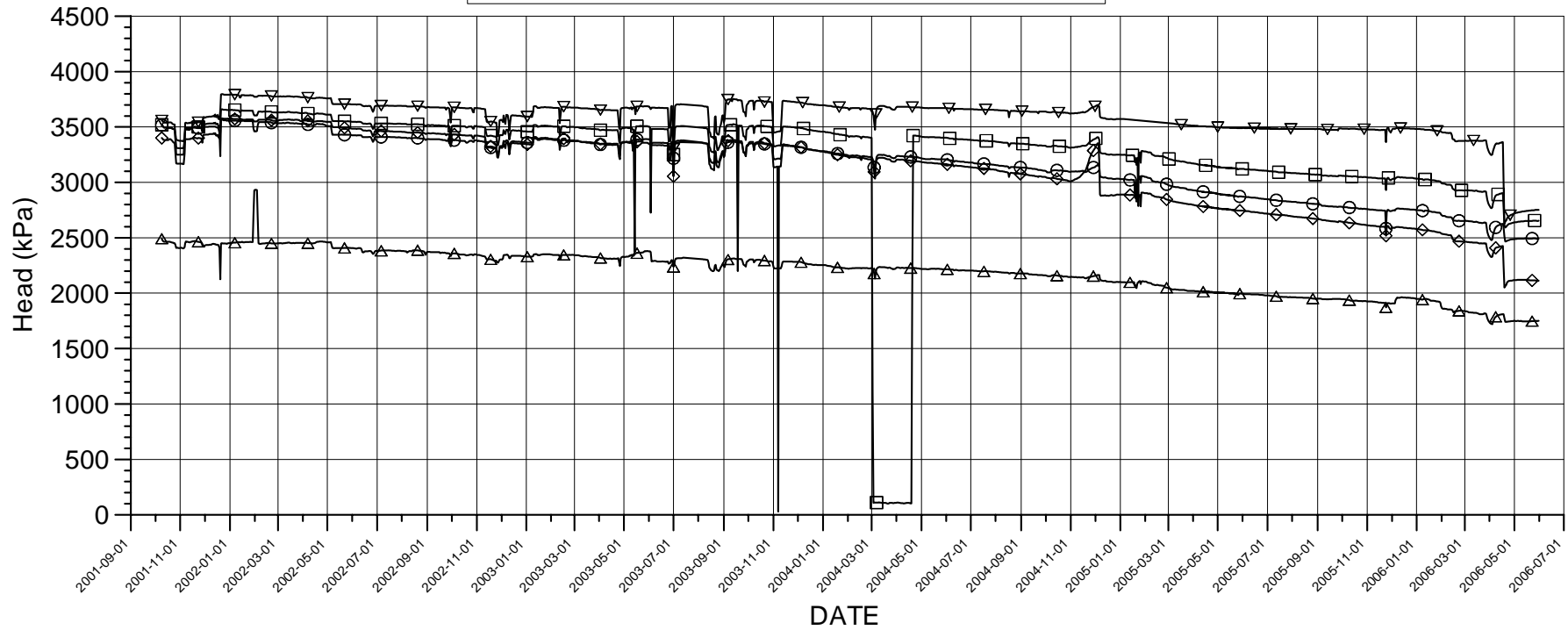
## Borehole sections

- ▽ — ▽ A01:1 42.5 m - 48.82 m
- ◇ — ◇ A01:2 37 m - 41.5 m
- — □ A01:3 35 m - 36 m
- — ○ A01:4 19 m - 34 m
- △ — △ A01:5 5 m - 18 m

P\_KG0021A01.GRF 2006-06-08



## KG0048A01 PRESSURE HEAD



### Events

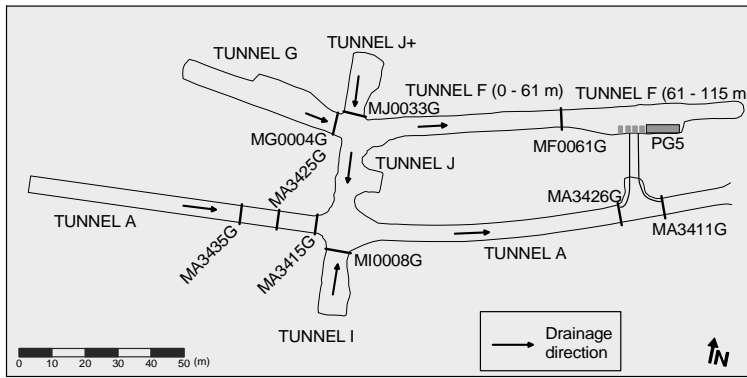
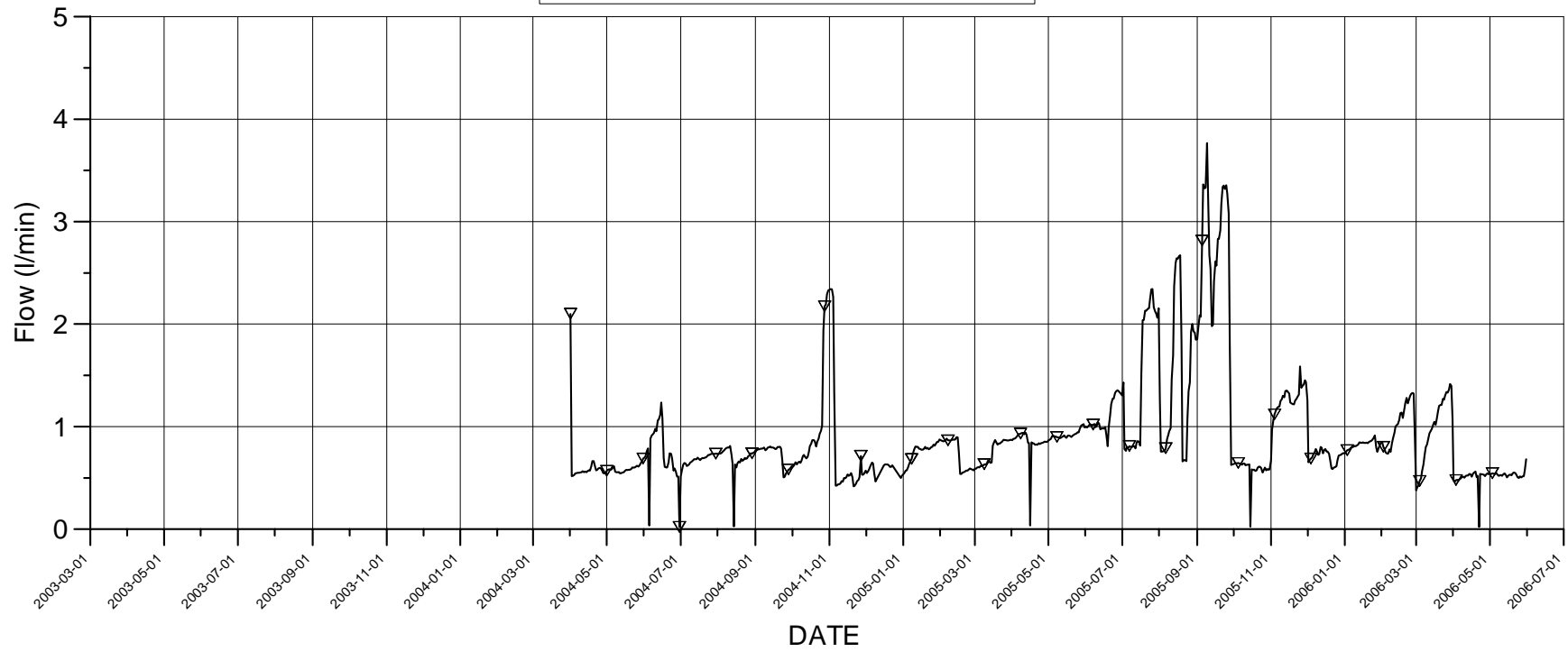
- Start backfilling of section I 2001-09-03
- Stop backfilling of section I 2001-11-20
- Casting of inner plug finalized 2001-12-19
- Start backfilling of section II 2003-04-29
- Stop backfilling of section II 2003-06-27
- Casting of outer plug finalized 2003-09-11

### Borehole sections

- ▽ — ▽ A01:1 49 m - 54.69 m
- ◇ — ◇ A01:2 34.8 m - 48 m
- — □ A01:3 32.8 m - 33.8 m
- — ○ A01:4 13 m - 31.8 m
- △ — △ A01:5 5 m - 12 m

P\_KG0048A01.GRF 2006-06-08

# MA3515G WEIR FLOW

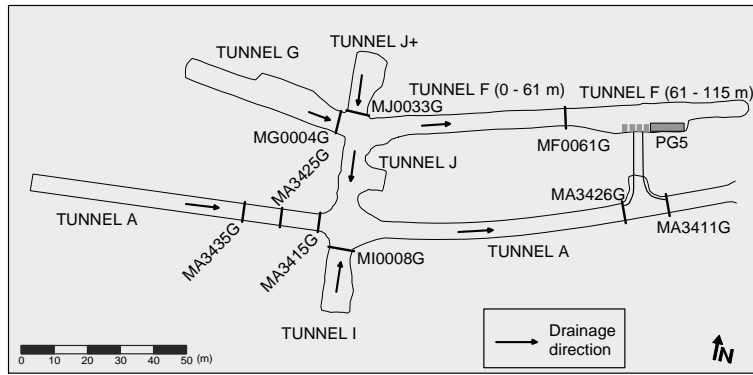
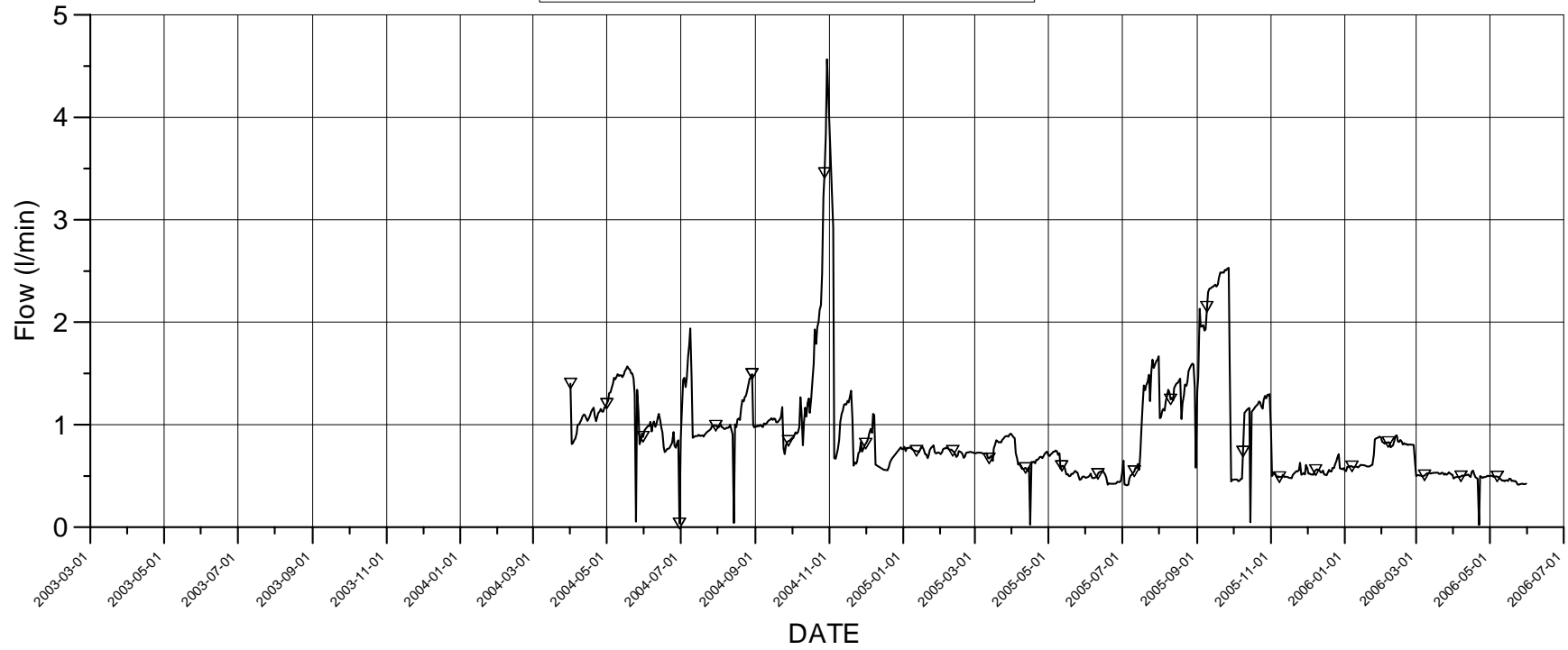


## Events

- Start backfilling of section I 2001-09-03
- Stop backfilling of section I 2001-11-20
- Casting of inner plug finalized 2001-12-19
- Start backfilling of section II 2003-04-29
- Stop backfilling of section II 2003-06-27
- Casting of outer plug finalized 2003-09-11

▽ — ▽ WEIR MA3515G

# MA3525G WEIR FLOW

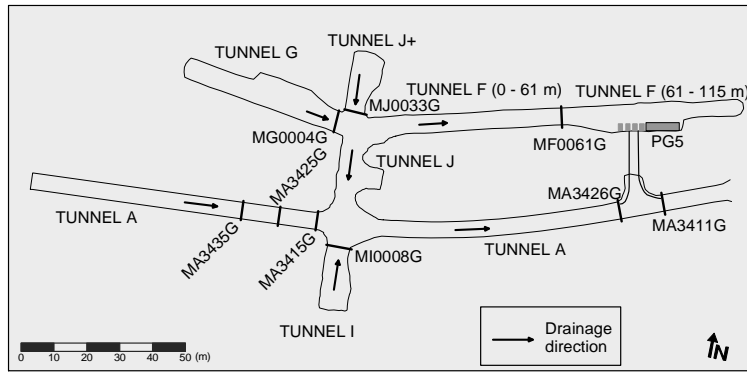
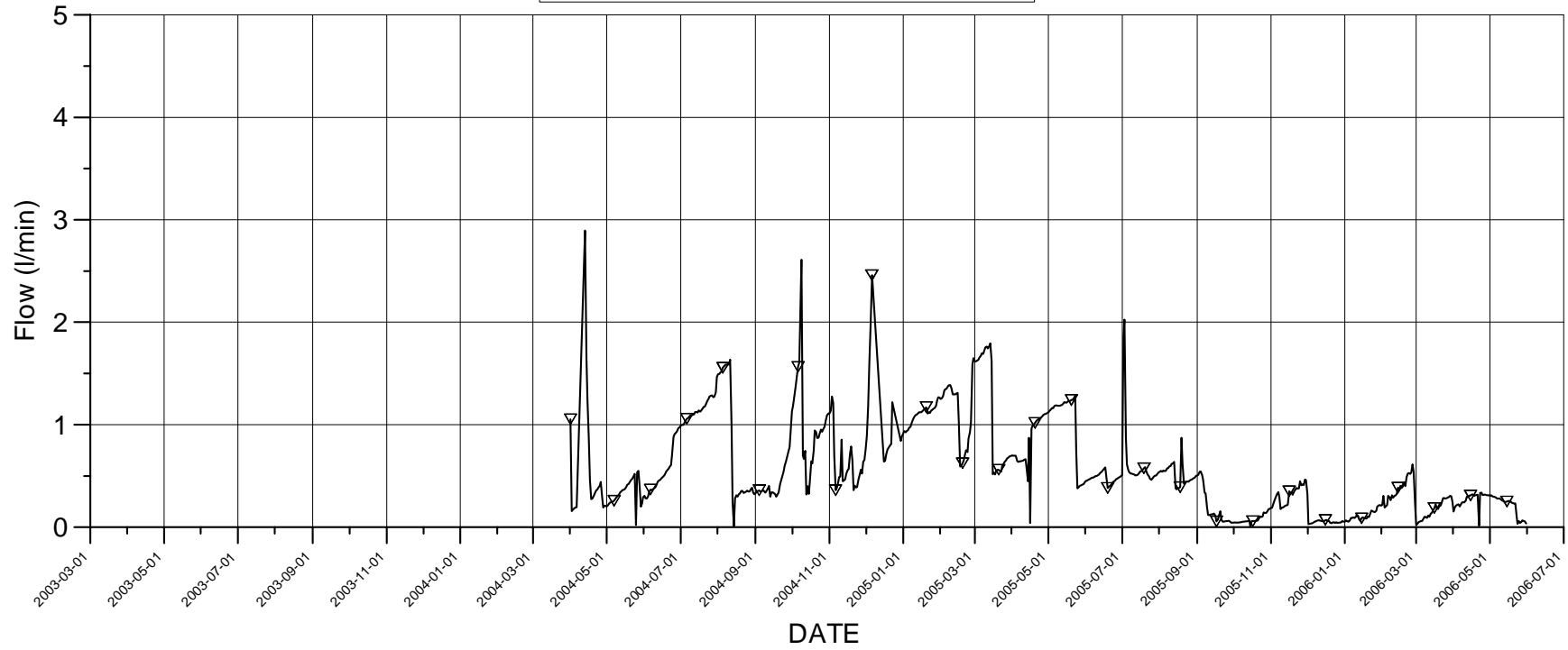


## Events

- Start backfilling of section I 2001-09-03
- Stop backfilling of section I 2001-11-20
- Casting of inner plug finalized 2001-12-19
- Start backfilling of section II 2003-04-29
- Stop backfilling of section II 2003-06-27
- Casting of outer plug finalized 2003-09-11



# MA3535G WEIR FLOW

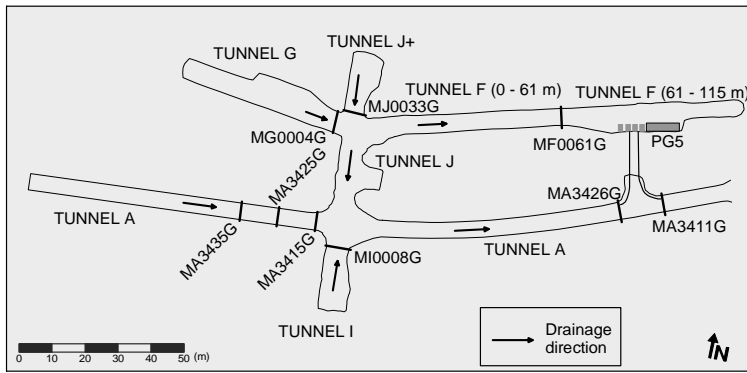
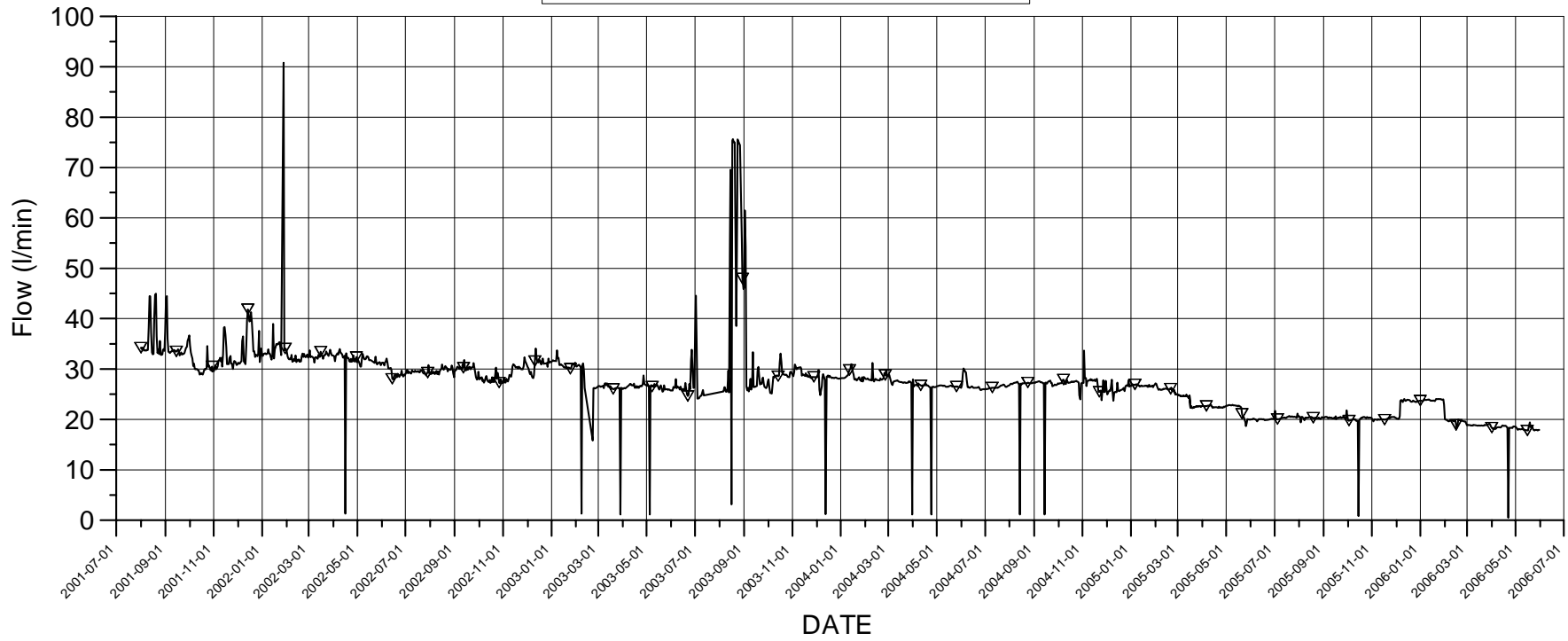


## Events

- Start backfilling of section I 2001-09-03
- Stop backfilling of section I 2001-11-20
- Casting of inner plug finalized 2001-12-19
- Start backfilling of section II 2003-04-29
- Stop backfilling of section II 2003-06-27
- Casting of outer plug finalized 2003-09-11



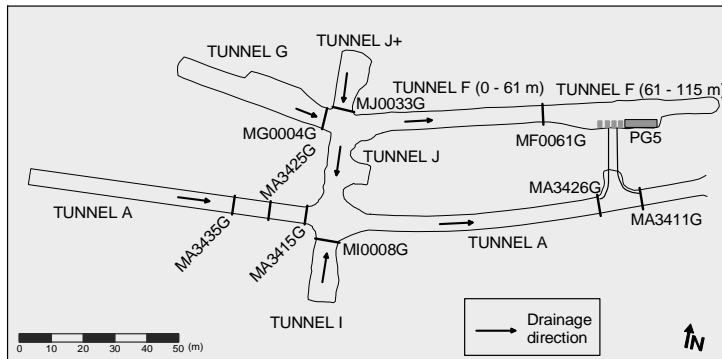
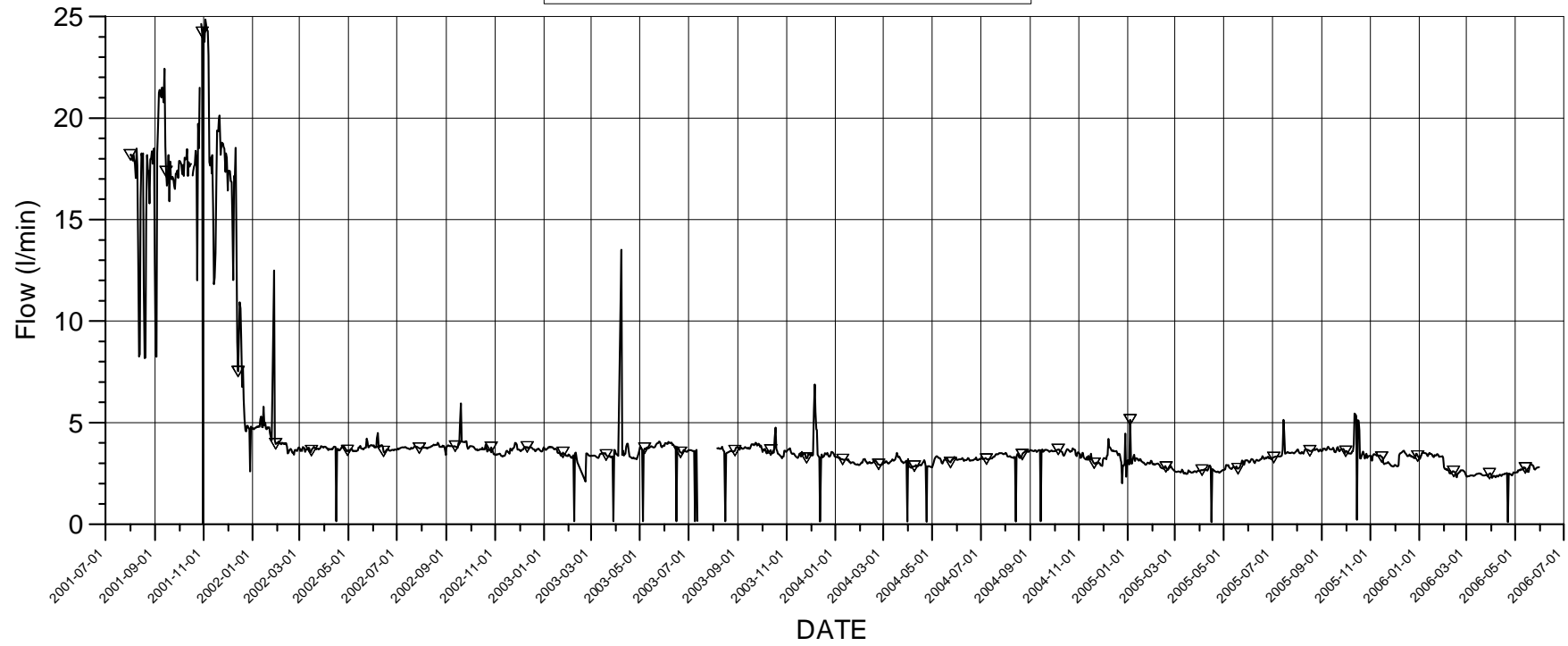
# MA3426G WEIR FLOW



- ### Events
- Start backfilling of section I 2001-09-03
  - Stop backfilling of section I 2001-11-20
  - Casting of inner plug finalized 2001-12-19
  - Start backfilling of section II 2003-04-29
  - Stop backfilling of section II 2003-06-27
  - Casting of outer plug finalized 2003-09-11



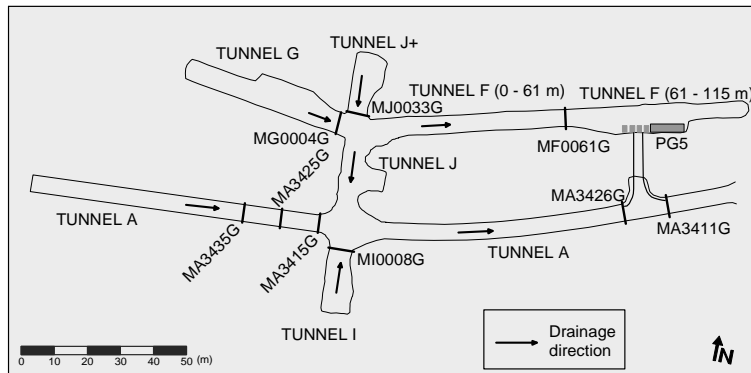
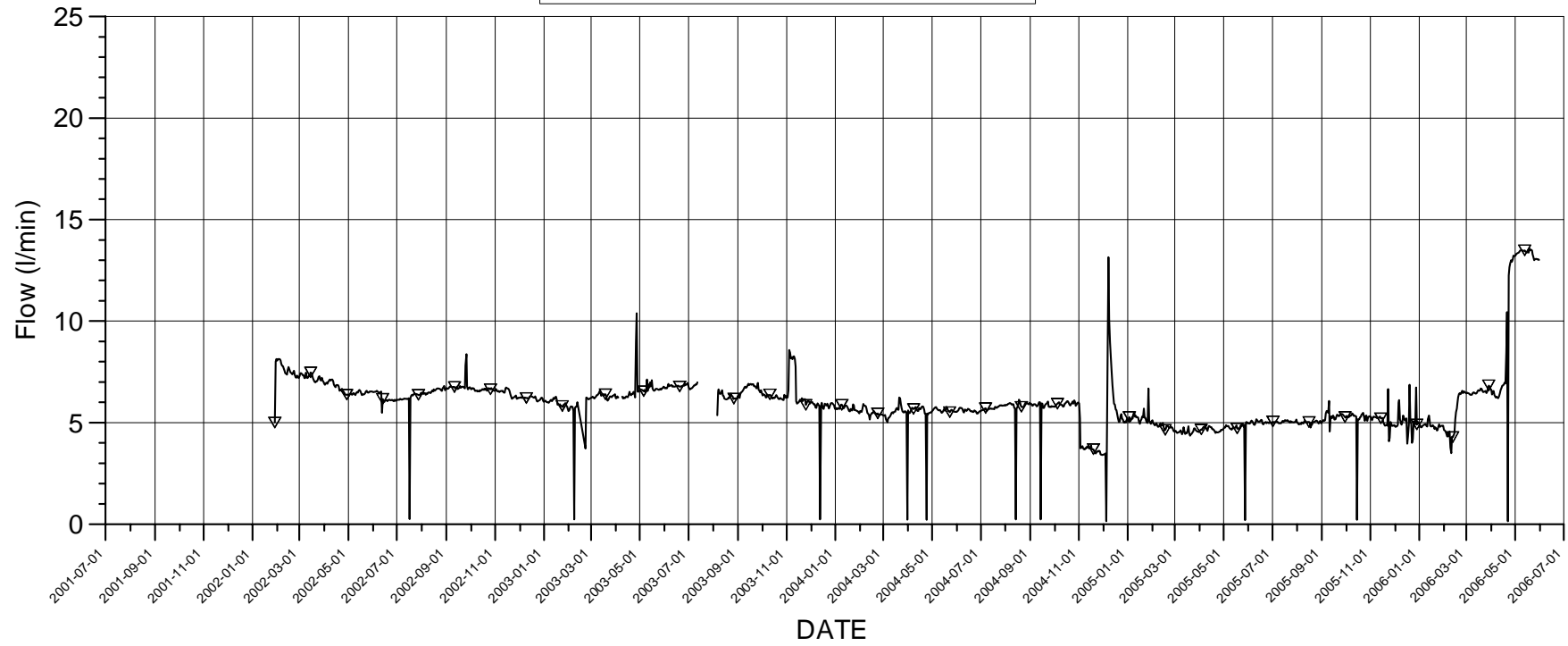
# MF0061G WEIR FLOW



- ### Events
- Start backfilling of section I 2001-09-03
  - Stop backfilling of section I 2001-11-20
  - Casting of inner plug finalized 2001-12-19
  - Start backfilling of section II 2003-04-29
  - Stop backfilling of section II 2003-06-27
  - Casting of outer plug finalized 2003-09-11



# MG0004G WEIR FLOW

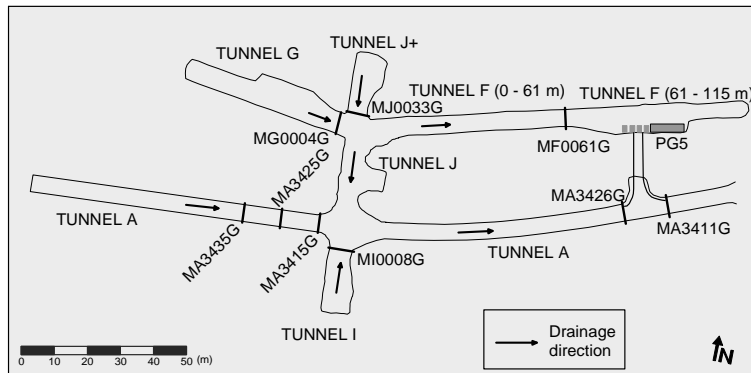
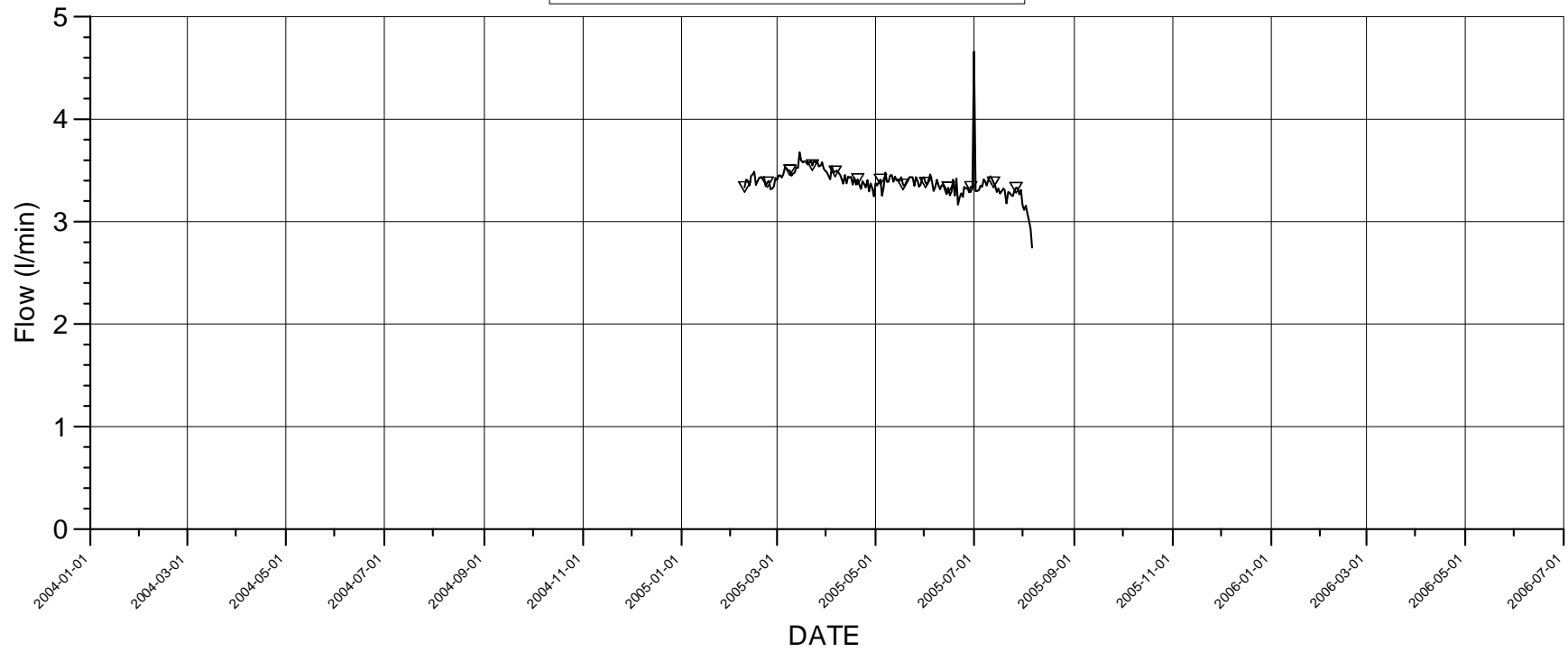


## Events

- Start backfilling of section I 2001-09-03
- Stop backfilling of section I 2001-11-20
- Casting of inner plug finalized 2001-12-19
- Start backfilling of section II 2003-04-29
- Stop backfilling of section II 2003-06-27
- Casting of outer plug finalized 2003-09-11

↔ WEIR MG0004G

# MI0008G WEIR FLOW



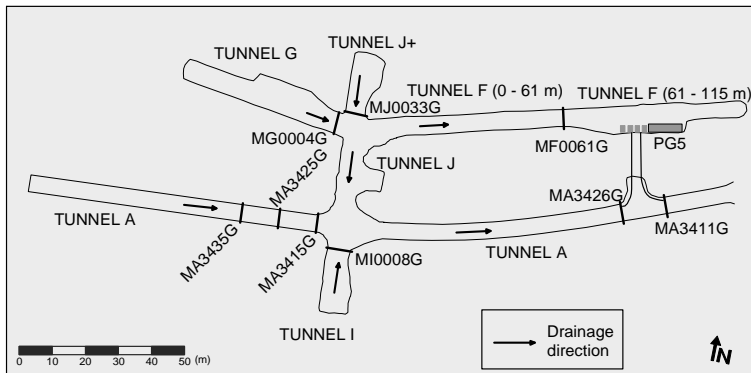
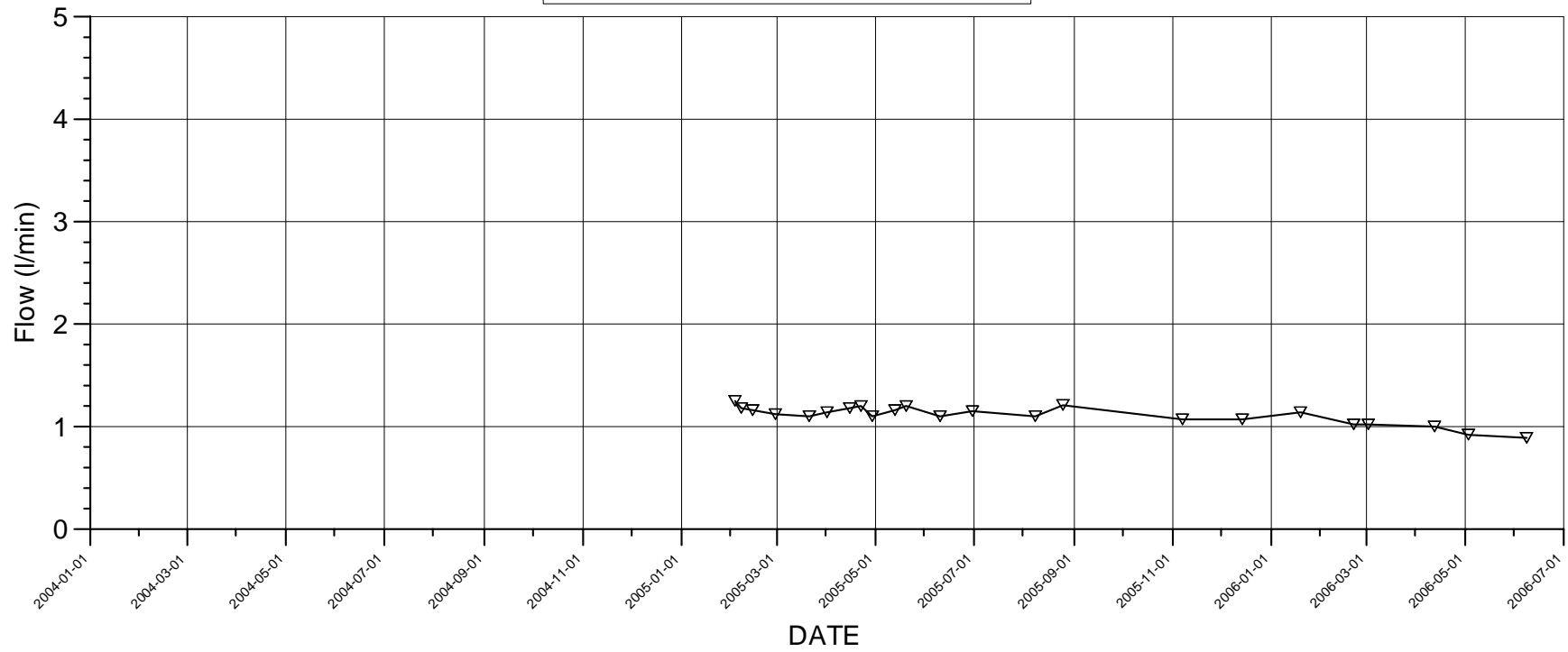
## Events

- Start backfilling of section I 2001-09-03
- Stop backfilling of section I 2001-11-20
- Casting of inner plug finalized 2001-12-19
- Start backfilling of section II 2003-04-29
- Stop backfilling of section II 2003-06-27
- Casting of outer plug finalized 2003-09-11





# MJ0033G WEIR FLOW



## Events

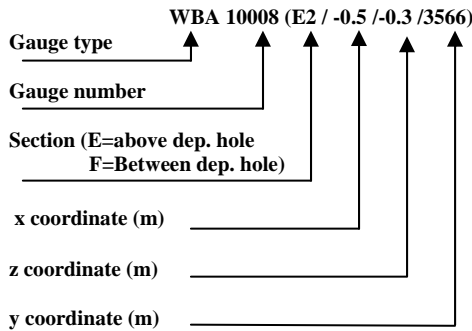
- Start backfilling of section I 2001-09-03
- Stop backfilling of section I 2001-11-20
- Casting of inner plug finalized 2001-12-19
- Start backfilling of section II 2003-04-29
- Stop backfilling of section II 2003-06-27
- Casting of outer plug finalized 2003-09-11



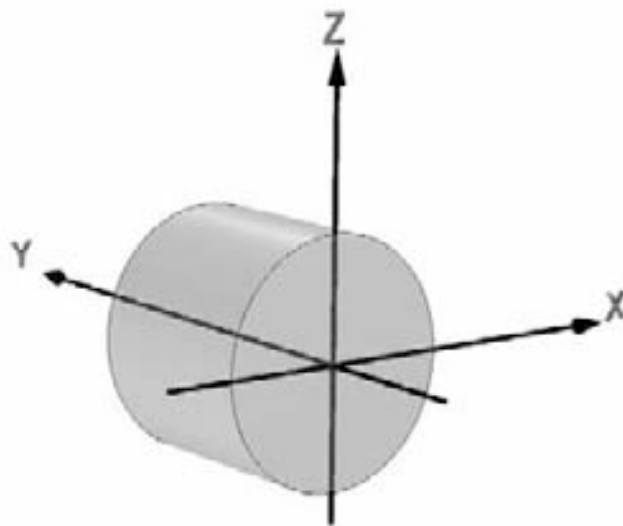


# Quick guide

## Transducers in the backfill

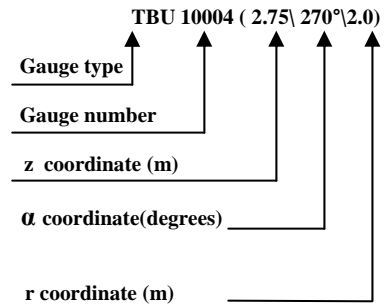


## Coordinate system in backfill

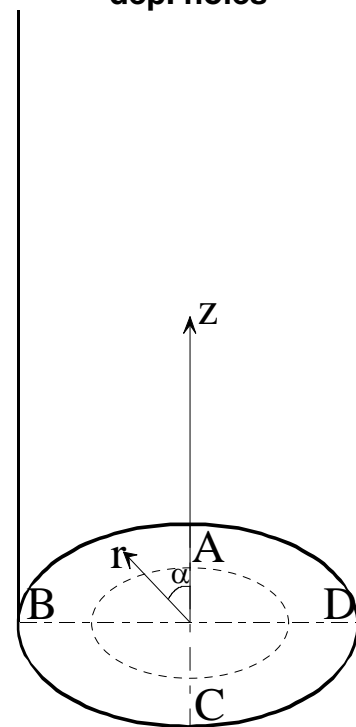


End of tunnel at Y = 3599.8 m  
 Center dep.hole 1.at Y = 3587 m  
 Center dep.hole 2 at Y = 3581 m  
 Center dep.hole 3 at Y = 3575 m  
 Center dep.hole 4 at Y = 3569 m  
 Inner plug surface at Y = 3561.4 m  
 Center dep.hole 5 at Y = 3551 m  
 Center dep.hole 6 at Y = 3545 m  
 Outer plug surface at Y = 3538.6 m  
 Tunnel radius Z=X = 2.5 m

## Transducers in dep. holes 1, 3,5 and 6 and in the rock



## Coordinate system in dep. holes



Tunnel direction C-A  
 Bottom of hole Z=0  
 Bottom of canister Z=0.5  
 Top of canister Z=5.400  
 Upper buffer surface Z=7.125  
 Dep. hole radius r=0.875  
 Canister radius r=0.525

